

Zynq UltraScale+ MPSoC: Embedded Design Tutorial

*A Hands-On Guide to Effective
Embedded System Design*

UG1209 (v2018.2) July 31, 2018



Revision History

The following table shows the revision history for this document.

Section	Revision Summary
31/07/2018 Version 2018.2	
General updates	Validated with Vivado® Design Suite and PetaLinux 2018.2.
05/05/2018 Version 2018.1	
General updates	Validated with Vivado Design Suite and PetaLinux 2018.1.
Secure Boot Sequence	Updated the section with more details and steps.
Isolation Configuration	Updated the section.

Table of Contents

Revision History	2
Chapter 1: Introduction	
About This Guide	5
How Zynq UltraScale+ Devices Offer a Single Chip Solution	6
How the Vivado Tools Expedite the Design Process	9
What You Need to Set Up Before Starting	10
Chapter 2: Zynq UltraScale+ MPSoC Processing System Configuration	
Zynq UltraScale+ System Configuration	13
Example Project: Creating a New Embedded Project with Zynq UltraScale+ MPSoC	14
Example Project: Running the “Hello World” Application from Arm Cortex-A53	30
Additional Information	34
Chapter 3: Build Software for PS Subsystems	
Processing Units in Zynq UltraScale+	36
Example Project: Create a Bare-Metal Application Project in SDK	37
Example Project: Create Linux Images using PetaLinux	47
Chapter 4: Debugging with SDK	
Xilinx System Debugger	53
Debugging Software Using SDK	55
Debugging Using XSCT	58
Chapter 5: Boot and Configuration	
System Software	68
Linux on APU and Bare-Metal on RPU	70
Boot Sequence for SD-Boot	70
Boot Sequence for QSPI Boot Mode	80
Boot Sequence for QSPI-Boot Mode Using JTAG	91
Boot Sequence for USB Boot Mode	94
Secure Boot Sequence	101

Chapter 6: System Design Examples

Design Example 1: Using GPIOs, Timers, and Interrupts	135
Design Example 2: Example Setup for Graphics and Display Port Based Sub-System	154

Appendix A: Debugging Problems with Secure Boot

Determine if PUF Registration is Running	161
Read the Boot Image	161

Appendix B: Additional Resources and Legal Notices

Xilinx Resources	162
Solution Centers	162
Documentation Navigator and Design Hubs	162
Design Files for This Tutorial	163
Xilinx Resources	163
Training Resources	164
Please Read: Important Legal Notices	165

Introduction

About This Guide

This document provides an introduction to using the Xilinx® Vivado® Design Suite flow for using the Zynq® UltraScale+™ MPSoC device. The examples are targeted for the Xilinx ZCU102 Rev1 evaluation board. The tool versions used are Vivado and the Xilinx Software Development Kit (SDK) 2018.2.

Note: To install SDK as part of the Vivado Design Suite, you must choose to include SDK in the installer. See [Xilinx Software Development Kit, page 8](#).

The examples in this document were created using the Xilinx tools running on Windows 7, 64-bit operating system, and PetaLinux on Linux 64-bit operating system. Other versions of the tools running on other Window installs might provide varied results. These examples focus on introducing you to the following aspects of embedded design.

Note: The sequence mentioned in the tutorial steps for booting Linux on the hardware is specific to the PetaLinux tools released for 2018.2, which must be installed on the Linux host machine for exercising the Linux portions of this document.

- [Chapter 2, Zynq UltraScale+ MPSoC Processing System Configuration](#) describes creation of a system with the Zynq UltraScale+ MPSoC Processing System (PS) and running a simple “Hello World” application on Arm® Cortex®-A53 and Cortex-R5 processors. This chapter is an introduction to the hardware and software tools using a simple design as the example.
- [Chapter 3, Build Software for PS Subsystems](#) describes steps to configure and build software for processing blocks in processing system, including application processing unit (APU), real-time processing unit (RPU), and platform management unit (PMU).
- [Chapter 4, Debugging with SDK](#) provides an introduction to debugging software using the debug features of the Xilinx Software Development Kit (SDK). This chapter uses the previous design and runs the software bare metal (without an OS) to show how to debug. This chapter also lists Debug configurations for Zynq UltraScale+ MPSoC.
- [Chapter 5, Boot and Configuration](#) shows integration of components to configure and create Boot images for a Zynq UltraScale+ system. The purpose of this chapter is to understand how to integrate and load Boot loaders.

- [Chapter 6, System Design Examples](#) highlights how you can use the software blocks you configured in [Chapter 3](#) to create a Zynq UltraScale+ system.
- [Appendix B, Additional Resources and Legal Notices](#) provides links to additional resources related to this guide.

Example Project

The best way to learn a tool is to use it. This guide provides opportunities for you to work with the tools under discussion. Specifications for sample projects are given in the example sections, along with an explanation of what is happening behind the scenes. Each chapter and examples are meant to showcase different aspects of embedded design. The example takes you through the entire flow to complete the learning and then moves on to another topic.

Additional Documentation

Additional documentation is listed in [Appendix B, Additional Resources and Legal Notices](#).

How Zynq UltraScale+ Devices Offer a Single Chip Solution

Zynq UltraScale+ MPSoC, the next generation Zynq device, is designed with the idea of using the right engine for the right task. The Zynq UltraScale+ comes with a versatile Processing System (PS) integrated with a highly flexible and high-performance Programmable Logic (PL) section, all on a single System on Chip (SoC). The Zynq UltraScale+ MPSoC PS block includes engines such as the following:

- Quad-core Arm Cortex-A53 based Application Processing Unit (APU)
- Dual-core Arm Cortex-R5 based Real Time Processing Unit (RPU)
- Arm Mali-400 MP2 based Graphics Processing Unit (GPU)
- Dedicated Platform Management Unit (PMU) and Configuration Security Unit (CSU)
- List of High Speed peripherals, including Display port and SATA

The Programmable Logic Section, in addition to the programmable logic cells, also comes integrated with few high performance peripherals, including the following:

- Integrated Block for PCI Express
- Integrated Block for Interlaken
- Integrated Block for 100G Ethernet
- System Monitor
- Video Codec Unit

The PS and the PL in Zynq UltraScale+ can be tightly or loosely coupled with a variety of high performance and high bandwidth PS-PL interfaces.

To simplify the design process for such sophisticated devices, Xilinx offers the Vivado Design Suite, Xilinx Software Development Kit (SDK), and PetaLinux Tools for Linux. This set of tools provides you with everything you need to simplify embedded system design for a device that merges an SoC with an FPGA. This combination of tools enables hardware and software application design, code execution and debug, and transfer of the design onto actual boards for verification and validation.

The Vivado Design Suite

Xilinx offers a broad range of development system tools, collectively called the Vivado Design Suite. Various Vivado Design Suite Editions can be used for embedded system development. In this guide we will utilize the System Edition. The Vivado Design Suite Editions are shown in the following figure.

Vivado Design Suite - HLx Editions

Vivado Design Suite - HLx Edition Features	Vivado HL Design Edition	Vivado HL System Edition	Vivado Lab Edition	Vivado HL WebPACK Edition (Device Limited)	Free 30-day Evaluation
Accelerating Implementation					
Synthesis and Place and Route	•	•		•	•
Partial Reconfiguration*	•	•		•	•
Accelerating Verification					
Vivado Simulator	•	•		•	•
Vivado Device Programmer	•	•	•	•	•
Vivado Logic Analyzer	•	•	•	•	•
Vivado Serial I/O Analyzer	•	•	•	•	•
Debug IP (ILA/VIO/IBERT)	•	•		•	•
Accelerating High Level Design					
Vivado High-Level Synthesis	•	•		•	•
Vivado IP Integrator	•	•		•	•
System Generator for DSP		•			•

* Can be purchased as an option.

Figure 1-1: Vivado Design Suite Editions

Other Vivado Components

Other Vivado components include:

- Embedded/Soft IP for the Xilinx embedded processors
- Documentation
- Sample projects

Xilinx Software Development Kit

The Software Development Kit (SDK) is an integrated development environment, complementary to Vivado, that is used for C/C++ embedded software application creation and verification. SDK is built on the Eclipse open-source framework and might appear familiar to you or members of your design team.

When you install the Vivado Design Suite, SDK is available as an optional software tool that you must choose to include in your installation. For details, refer to [Installation Requirements, page 10](#).

For more information about the Eclipse development environment, refer to <http://www.eclipse.org>.

Other SDK components include:

- Drivers and libraries for embedded software development
- Linaro GCC compiler for C/C++ software development targeting the Arm Cortex-A53 and Arm Cortex-R5 MPCore processors in the Zynq UltraScale+ Processing System

PetaLinux Tools

The PetaLinux tools set is an Embedded Linux System Development Kit. It offers a multi-faceted Linux tool flow, which enables complete configuration, build, and deploy environment for Linux OS for the Xilinx Zynq devices, including Zynq UltraScale+.

For more information, see the *PetaLinux Tools Documentation: Reference Guide* (UG1144) [Ref 7].

The PetaLinux Tools design hub provides information and links to documentation specific to PetaLinux Tools. For more information, see [Documentation Navigator and Design Hubs](#).

How the Vivado Tools Expedite the Design Process

You can use the Vivado Design Suite tools to add design sources to your hardware. These include the IP integrator, which simplifies the process of adding IP to your existing project and creating connections for ports (such as clock and reset).

You can accomplish all your hardware system development using the Vivado tools along with IP integrator. This includes specification of the Zynq UltraScale+ Processing System, peripherals, and the interconnection of these components, along with their respective detailed configuration.

SDK is used for software development and is available either as part of the Vivado Design Suite, or it can be installed and used without any other Xilinx tools installed on the machine on which it is loaded. SDK can also be used to debug software applications.

The Zynq UltraScale+ Processing System (PS) can be booted and run without programming the FPGA (programmable logic or PL). However, in order to use any soft IP in the fabric, or to bond out PS peripherals using EMIO, programming of the PL is required. You can program the PL using SDK or using the Vivado Hardware Manager.

For more information on the embedded design process, refer to the *Vivado Design Suite Tutorial: Embedded Processor Hardware Design* (UG940) [Ref 2].

For more information about the Zynq UltraScale+ Processing System, refer to the *Zynq UltraScale+ Processing System Product Guide* (PG201) [Ref 9].

What You Need to Set Up Before Starting

Before discussing the tools in depth, you should make sure they are installed properly and your environments match those required for the "Example Project" sections of this guide.

Hardware Requirements for this Guide

This tutorial targets the Zynq UltraScale+ ZCU102 evaluation board. The examples in this tutorial were tested using the ZCU102 Rev 1 board. To use this guide, you need the following hardware items, which are included with the evaluation board:

- ZCU102 Rev1 evaluation board
- AC power adapter (12 VDC)
- USB Type-A to USB Micro cable (for UART communications)
- USB Micro cable for programming and debugging via USB-Micro JTAG connection
- SD-MMC flash card for Linux booting
- Ethernet cable to connect target board with host machine
- Monitor with Display Port (DP) capability and at least 1080P resolution.
- DP cable to connect the Display output from ZCU102 Board to a DP monitor.

Installation Requirements

Vivado Design Suite and SDK

Make sure that you have installed the 2018.2 Vivado HL System Edition tools. Visit <https://www.xilinx.com/support/download.html> to confirm that you have the latest tools version.

Ensure that you have both the Vivado Design Suite and SDK Tools installed. When you install the Vivado Design Suite, SDK is available as an optional software tool that you must elect to include in your installation by selecting the **Software Development Kit** check box, as shown in the following figure. To install SDK by itself, you can deselect the other software products and run the installer with only **Software Development Kit** selected.

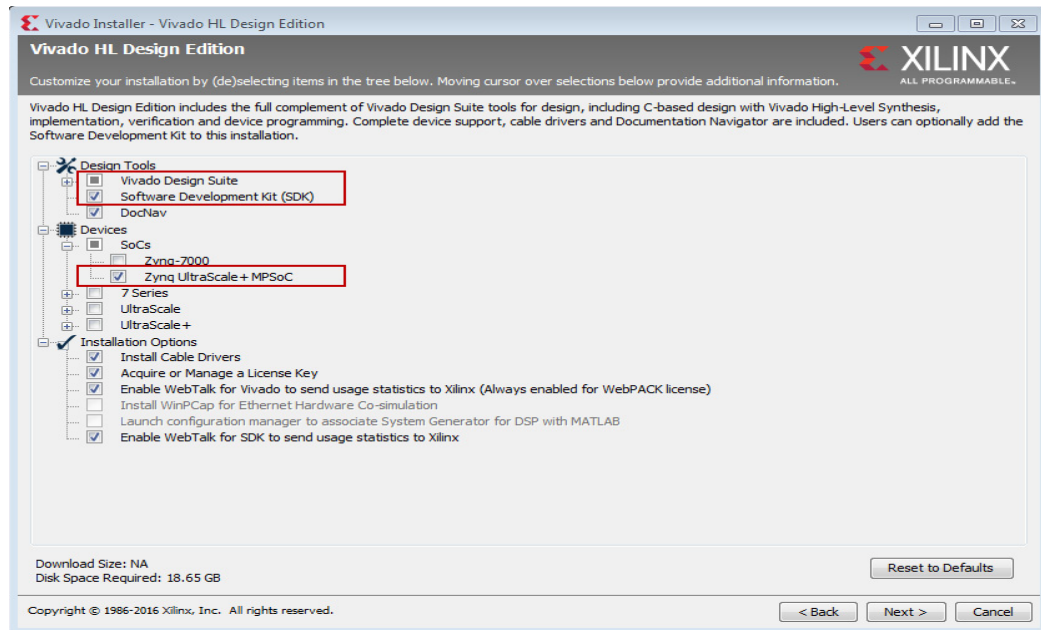

Figure 1-2: Vivado Installer - Select Software Development Kit

For more information on installing the Vivado Design Suite and SDK, refer to the *Vivado Design Suite User Guide: Release Notes, Installation, and Licensing* (UG973) [Ref 3].

IMPORTANT: Installation does not create an SDK desktop shortcut by default. You can launch the SDK binary from `C:\Xilinx\SDK\2018.2\bin\xsdk.bat`.

PetaLinux Tools

Install the PetaLinux Tools to run through the Linux portion of this tutorial. PetaLinux tools run under the Linux host system running one of the following:

- RHEL 7.2/7.3 (64-bit)
- CentOS 7.2/7.3 (64-bit)
- Ubuntu 16.04.1/2 (64-bit)

Note: For more information, see Xilinx Answer [70395](#).

This can use either a dedicated Linux host system or a virtual machine running one of these Linux operating systems on your Windows development platform.

When you install PetaLinux Tools on your system of choice, you must do the following:

- Download PetaLinux 2018.2 SDK software from the [Xilinx Website](#).
- Download the ZCU102 PetaLinux BSP (ZCU102 BSP (prod-silicon)) from the [2018.2 downloads](#) page.

- Add common system packages and libraries to the workstation or virtual machine. For more information, see the Installation Requirements from the *PetaLinux Tools Documentation: Reference Guide* (UG1144) [Ref 7].

Prerequisites

- 8 GB RAM (recommended minimum for Xilinx tools)
- 2 GHz CPU clock or equivalent (minimum of 8cores)
- 100 GB free HDD space

Extract the PetaLinux Package

By default, the installer installs the package as a subdirectory within the current directory. Alternatively, you can specify an installation path. Run the downloaded PetaLinux installer.

Note: Ensure that the PetaLinux installation path is kept short. The PetaLinux build will fail if the path exceeds 255 characters.

```
bash> ./petalinux-v2018.2-final-installer.run
```

PetaLinux is installed in the `petalinux-v2018.2-final` directory, directly underneath the working directory of this command. If the installer is placed in the home directory `/home/user`, PetaLinux is installed in `/home/user/petalinux-v2018.2-final`.

Refer to [Chapter 3, Build Software for PS Subsystems](#) for additional information about the PetaLinux environment setup, project creation, and project usage examples. A detailed guide on PetaLinux Installation and usage can be found in the *PetaLinux Tools Documentation: Reference Guide* (UG1144) [Ref 7].

Software Licensing

Xilinx software uses FLEXnet licensing. When the software is first run, it performs a license verification process. If the license verification does not find a valid license, the license wizard guides you through the process of obtaining a license and ensuring that the license can be used with the tools installed. If you do not need the full version of the software, you can use an evaluation license. For installation instructions and information, see the *Vivado Design Suite User Guide: Release Notes, Installation, and Licensing* (UG973) [Ref 3].

Tutorial Design Files

See [Design Files for This Tutorial, page 163](#) for information about downloading the design files for this tutorial.

Zynq UltraScale+ MPSoC Processing System Configuration

Now that you have been introduced to the Xilinx® Vivado® Design Suite, you will begin looking at how to use it to develop an embedded system using the Zynq® UltraScale+™ MPSoC Processing System (PS).

The Zynq UltraScale+ device consists of Quad-Core Arm® Cortex®-A53 based APU, Dual-Core Arm Cortex-R5 RPU, Mali 400 MP2 GPU, and many hard Intellectual Property components (IPs), and Programmable Logic (PL). This offering can be used in two ways:

- The Zynq UltraScale+ PS can be used in a standalone mode, without attaching any additional fabric IP.
- IP cores can be instantiated in fabric and attached to the Zynq UltraScale+ PS as a PS+PL combination.

Zynq UltraScale+ System Configuration

Creation of a Zynq UltraScale+ system design involves configuring the PS to select the appropriate boot devices and peripherals. To start with, as long as the PS peripherals and available MIO connections meet the design requirements, no bitstream is required. This chapter guides you through creating a simple PS-based design that does not require a bitstream.

In addition to the basic PS configuration, this chapter will also guide you through the Isolation Configuration flow to create subsystems with protected memory and peripherals. This advanced configuration mode in the PS Block enables you to setup subsystems comprising Masters with dedicated memory and peripherals. The protection is provided by the XMPU and the XPPU in Zynq UltraScale+ PS block. The isolation configuration also allows the TrustZone settings for components to create and configure the systems in Secure and Non-Secure Environments.

Example Project: Creating a New Embedded Project with Zynq UltraScale+ MPSoC

For this example, you will launch the Vivado Design Suite and create a project with an embedded processor system as the top level.

Starting Your Design

1. Start the Vivado Design Suite.
2. In the Vivado Quick Start page, click **Create Project** to open the New Project wizard.
3. Use the information in the table below to make selections in each of the wizard screens.

Table 2-1: New Project Wizard Options

Wizard Screen	System Property	Setting or Command to Use
Project Name	Project name	edt_zcu102
	Project Location	C:/edt
	Create Project Subdirectory	Leave this checked
Project Type	Specify the type of sources for your design. You can start with RTL or a synthesized EDIF.	RTL Project
	Do not specify sources at this time check box	Leave this unchecked.
Add Sources	Do not make any changes to this screen.	
Add Constraints	Do not make any changes to this screen.	
Default Part	Select	Boards
	Display Name	Zynq UltraScale+ ZCU102 Evaluation Board
New Project Summary	Project Summary	Review the project summary

4. Click **Finish**. The New Project wizard closes and the project you just created opens in the Vivado design tool.

Creating a Block Design Project

You will now use the IP Integrator to create a Block Design project.

1. In the Flow Navigator, under **IP Integrator**, click **Create Block Design**.

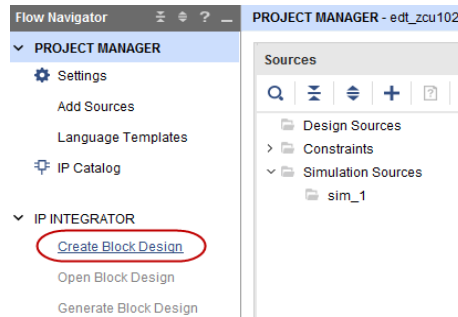

Figure 2-1: Create Block Design Button

The Create Block Design wizard opens.

- Use the following information to make selections in the Create Block Design wizard.

Table 2-2: Setting in Create Block Design Wizard

Wizard Screen	System Property	Setting or Command to Use
Create Block Design	Design Name	edt_zcu102
	Directory	<Local to Project>
	Specify Source Set	Design Sources

- Click **OK**.

The Diagram window view opens with a message that states that this design is empty. To get started, you will next add some IP from the catalog.

- Click the **Add IP** button **+**.
- In the search box, type `zynq` to find the Zynq device IP.
- Double-click the **ZYNQ UltraScale+ MPSoC** IP to add it to the Block Design.

The Zynq UltraScale+ MPSoC processing system IP block appears in the Diagram view, as shown in the following figure.

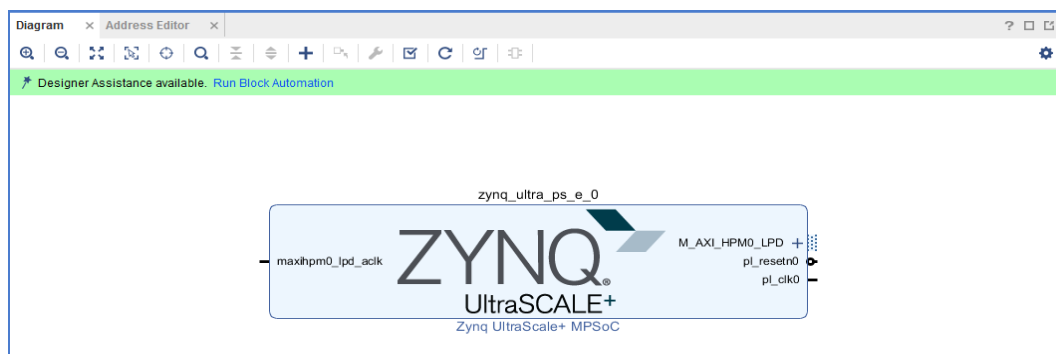

Figure 2-2: Zynq UltraScale+ MPSoC Processing System IP Block

Managing the Zynq UltraScale+ Processing System in Vivado

Now that you have added the processor system for the Zynq MPSoC to the design, you can begin managing the available options.

1. Double-click the **ZYNQ UltraScale+ Processing System** block in the Block Diagram window.

The Re-customize IP dialog box opens, as shown in the following figure. Notice that by default, the processor system does not have any peripherals connected

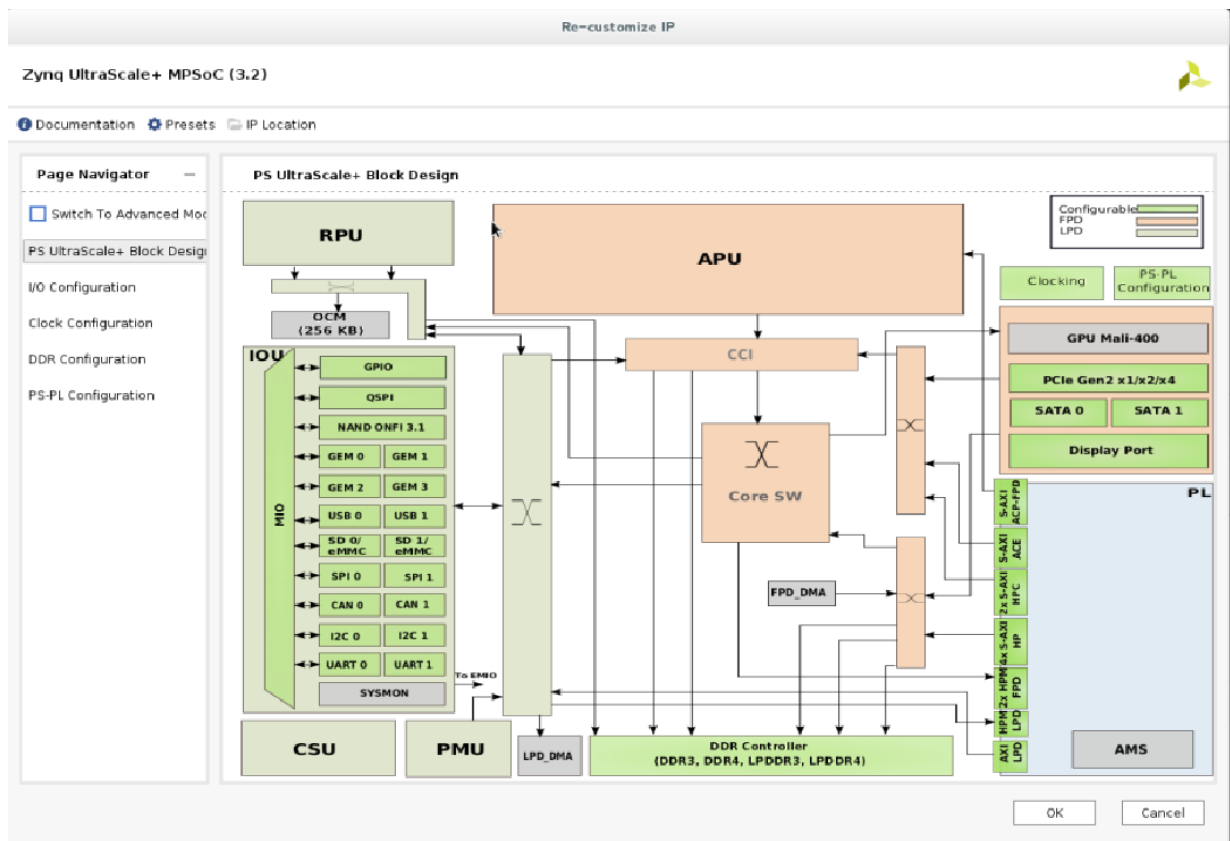

Figure 2-3: Re-customize IP Dialog Box

2. Click **Cancel** to exit the dialog box without making changes to the design.



TIP: In the Block Diagram window, notice the message stating that designer assistance is available, as shown in the following figure. When designer assistance is available, you can click the link to have Vivado perform that step in your design.

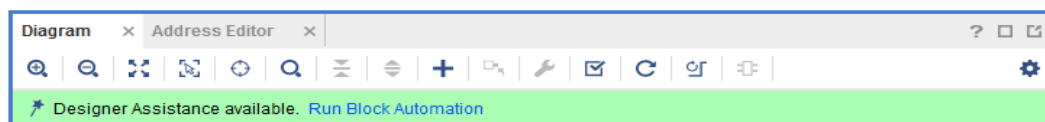

Figure 2-4: Designer Assistance Link

3. You will now use a preset template created for the ZCU102 board. Click the **Run Block Automation** Link.

The Run Block Automation dialog box opens.

4. Click **OK** to accept the default processor system options and make default pin connections.

This configuration wizard enables many peripherals in the Processing System with some multiplexed I/O (MIO) pins assigned to them according to the board layout of the ZCU102 board. For example, UART0 and UART1 are enabled. The UART signals are connected to a USB-UART connector through UART to the USB converter chip on the ZCU102 board.

5. To verify, double-click on the **Zynq UltraScale+ Processing System** block in the block diagram window.

Note the check marks that appear next to each peripheral name in the Zynq UltraScale+ device block diagram, signifying the I/O Peripherals that are active.

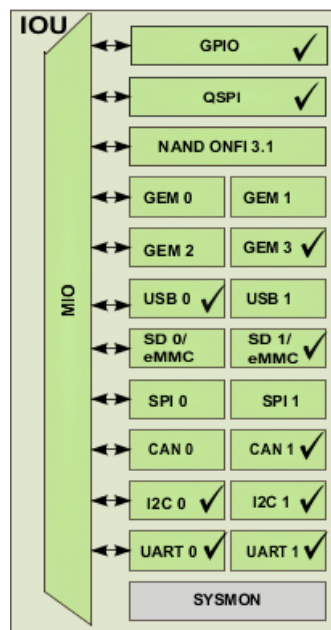

Figure 2-5: I/O Unit with Active Peripherals Identified

- In the block diagram, click one of the green I/O Peripherals, as shown in the previous figure. The IO Configuration dialog box opens for the selected peripheral.

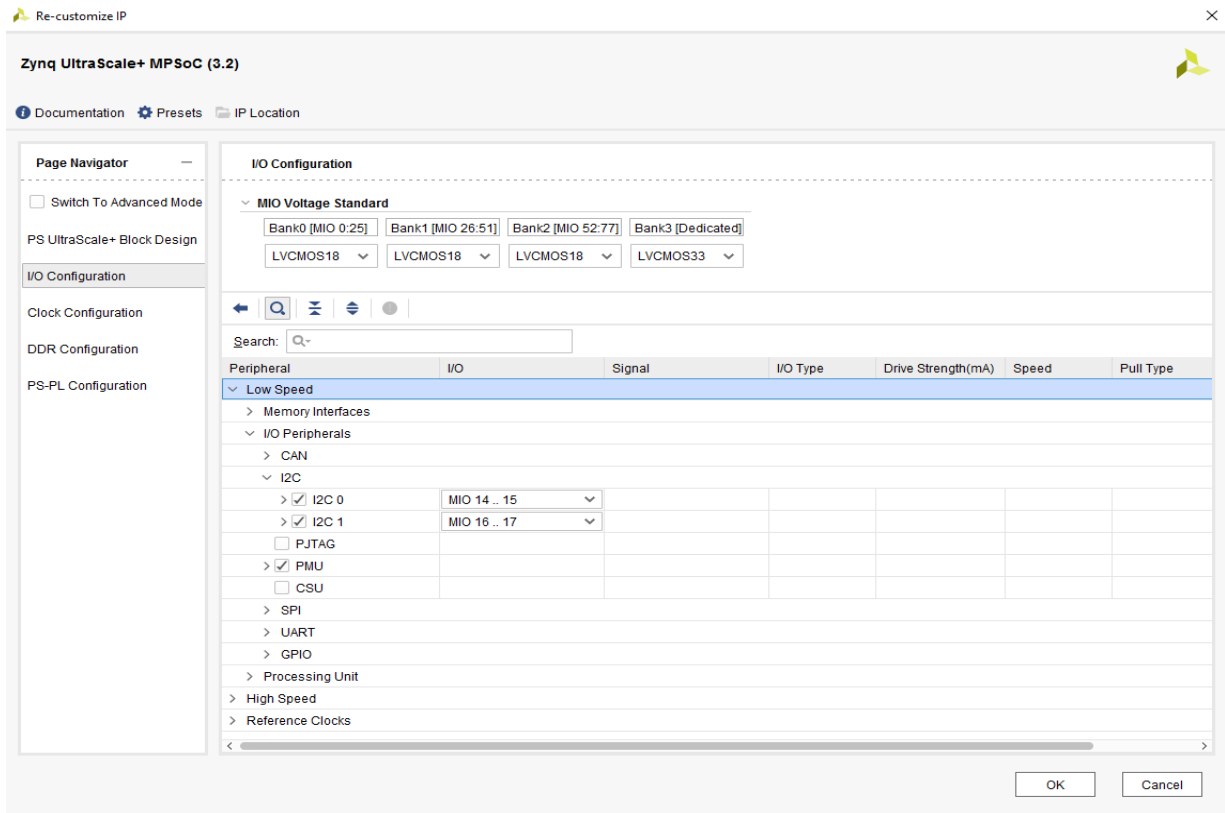

Figure 2-6: I/O Configuration Page of the Re-customize IP Dialog Box

This page enables you to configure low speed and high speed peripherals. For this example, you will continue with the basic connection enabled using Board preset for ZCU102.

- In the Page Navigator, select **PS-PL Configuration**.
- In PS-PL Configuration, expand **PS-PL Interfaces** and expand the **Master Interface**.

For this example, because there is no design in PL, you can disable the PS-PL interface. In this case, AXI HPM0 FPD and AXI HPM1 FPD Master Interfaces can be disabled.

- De-select **AXI HPM0 FPD** and **AXI HPM1 FPD**.

The PS-PL configuration looks like following figure.

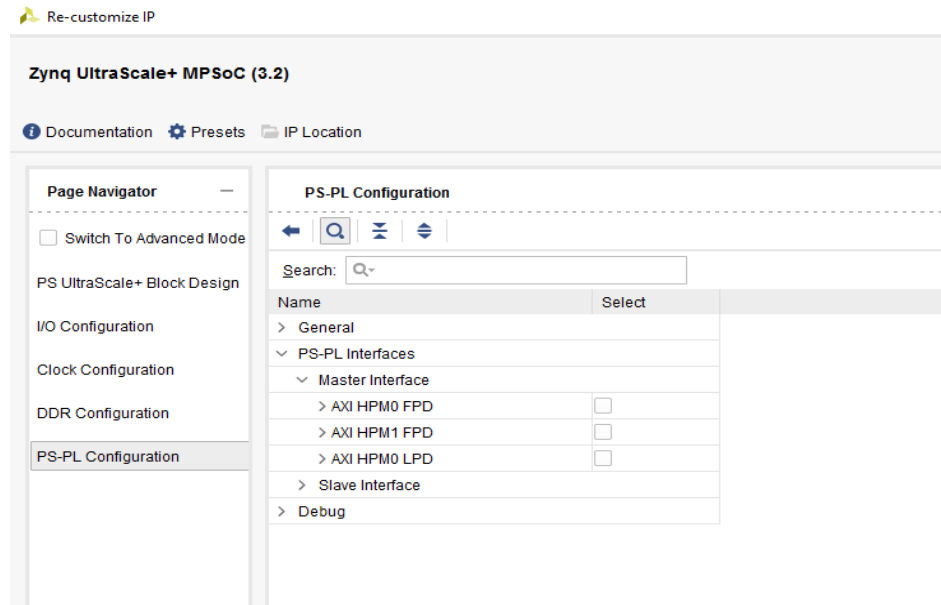

Figure 2-7: PS-PL Configuration

10. Click **OK** to close the Re-customize IP wizard.

Isolation Configuration

The Xilinx Memory Protection Unit (XMPU) and Xilinx Peripheral Protection Unit (XPPU) in Zynq UltraScale+ provide hardware protection for memory and peripherals. These protection units complement the isolation provided by TrustZone (TZ) and the Zynq UltraScale+ MPSoC SMMU. From a tools standpoint these Protection Units can be configured via Isolation Configuration in Zynq UltraScale+ PS IP wizard. The Isolation settings are exported as an initialization file which is loaded as a part of the bootloader, in this case the First Stage Boot Loader (FSBL). For more details, see the *Zynq UltraScale+ MPSoC Technical Reference Manual* (UG1085) [Ref 5].

Use the following steps to create a simple isolation based system. Switch to the Advanced mode to setup the Isolation Configuration.

1. Double-click the **Zynq UltraScale+ Processing System** in the block diagram window, if it is not open.
2. Select **Switch To Advanced Mode**.

Notice the protection boundaries indicated by red blocks in the block design.

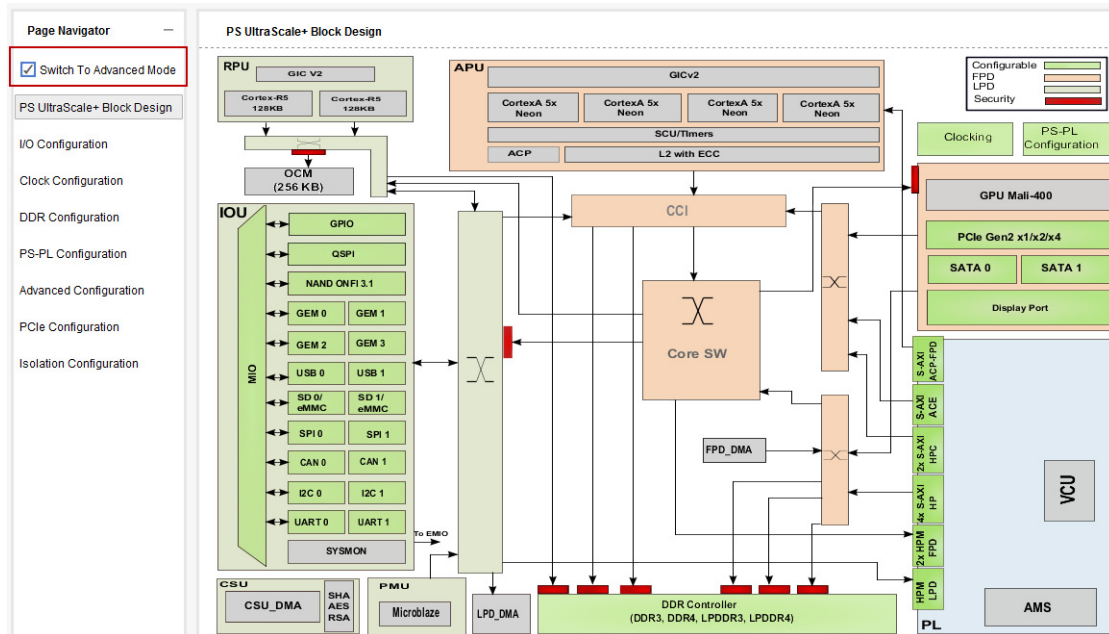

Figure 2-8: PS Configuration Advanced Mode

3. Click Isolation **Configuration** > **Enable Isolation**.
4. If not selected, select **Enable Secure Debug** to allow DAP master access to all slaves in the system. This is only to enable easy debug during the development phase. This can be disabled for production release.

As you can see, the PMU Subsystem is already enabled by default. This can be modified to match a custom system configuration, however it is recommended to edit the PMU Firmware subsystem only if necessary. The PMU is set as the XMPU/XPPU master in the pmu_subsystem. This tutorial focuses on isolation between APU and RPU subsystems.

Create an RPU Subsystem

Use the following steps to create a new RPU subsystem.

1. Click the + icon and select **Add New Subsystem**.

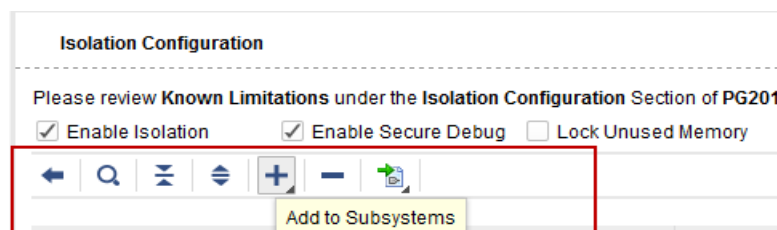

Figure 2-9: Add New Subsystem

2. Enter **RPU** in the dialog box, followed by the Enter key.

3. Click the + icon and then select **Add New Subsystem**.
4. Enter **APU** in the dialog box, followed by the Enter key.
5. Right click **RPU** and select **Add Master** and then double-click **RPU0** under **Processors**.

By default the RPU0 master is set with the Secure Trustzone settings.

6. Right-click on **RPU** and select **Add Slaves**, then double-click **Memory > DDR_LOW**. Change the DDR size to 240 MB. Set the start address to 0x70000000.
7. Right-click on **Memory** and select **Add**, then double-click **DDR_LOW**. Change the DDR size to 240 MB. Set the start address to 0x70000000.
8. Right-click on **RPU** and select **Add Slaves**, then double-click **Peripherals > UART1**.
9. Right-click on **Peripherals** and select **Add**, then double-click **GPIO**.
10. Right-click on **Peripherals** and select **Add**, then double-click **SWDT0**.
11. Right-click on **RPU** and select **Add Slaves**, then double-click **Control and Status Registers > CRF_APB**.
12. Right-click on **Control and Status Registers** and select **Add**, then double-click **RPU**.
13. Right-click on **Control and Status Registers** and select **Add**, then double-click **EFUSE**.
14. Right-click on **Control and Status Registers** and select **Add**, then double-click **IOU_SLCR**.
15. Right-click on **Control and Status Registers** and select **Add**, then double-click **CRL_APB**.

Note: Change all the Control and Status Register Tz settings to 'Secure'.

Create an APU Subsystem

Use the following steps to create a new APU subsystem.

1. Right-click on **APU** and select **Add Master**, then double-click **Processors > APU**.
 2. Right-click on **APU** and select **Add Slaves**, then double-click **Memory > DDR_LOW**. Change the DDR size to 1750 MB.
 3. Set the start address to 0x0 .
 4. Right-click on **Memory** and select **Add**, then double-click **DDR_LOW**. Change the DDR size to 1 MB.
 5. Set the start address to 0x6FF00000 .
- Note:** This 1 MB of DDR space can be accessed by both APU and RPU.
6. Right-click on **APU** and select **Add Slaves**, then double-click **Peripherals > GPIO**.
 7. Right-click on **Peripherals** and select **Add**, then double-click **SWDT1**.

8. Right-click on **APU** and select **Add Slaves**, then double-click **Control and Status Registers > CRF_APB**.
9. Right-click on **Control and Status Registers** and select **Add**, then double-click **RPU**.
10. Right-click on **Control and Status Registers** and select **Add**, then double-click **EFUSE**.
11. Right-click on **Control and Status Registers** and select **Add**, then double-click **IOU_SLCR**.
12. Right-click on **Control and Status Registers** and select **Add**, then double-click **CRL_APB**.

Note: Change all the Control and Status Register Tz settings to 'Secure'.

Create a DMA_Masters Subsystem

Use the following steps to create a new USB subsystem.

1. Click the + icon and select **Add New Subsystem**.
2. Enter **DMA_Masters** in the dialog box, followed by the Enter key.
3. Right-click on **DMA_Masters** and select **Add Master**, then double-click **Processors > APU**.
4. Right-click on **DMA_Masters** and select **Add Master**, then double-click **Processors > USB0**.
5. Right-click on **DMA_Masters** and select **Add Master**, then double-click **I/O Peripherals > SD1**.
6. Right-click on **DMA_Masters** and select **Add Master**, then double-click **Memory Interfaces > QSPI**.
7. Right-click on **DMA_Masters** and select **Add Slaves**, then double-click **Memory > DDR_LOW**. Change the DDR size to 1750 MB.
8. Set the start address to 0x0.
9. Right-click on **Memory** and select **Add**, then double-click **DDR_LOW**. Change the DDR size to 1 MB.
10. Set the start address to 0x6FF00000.

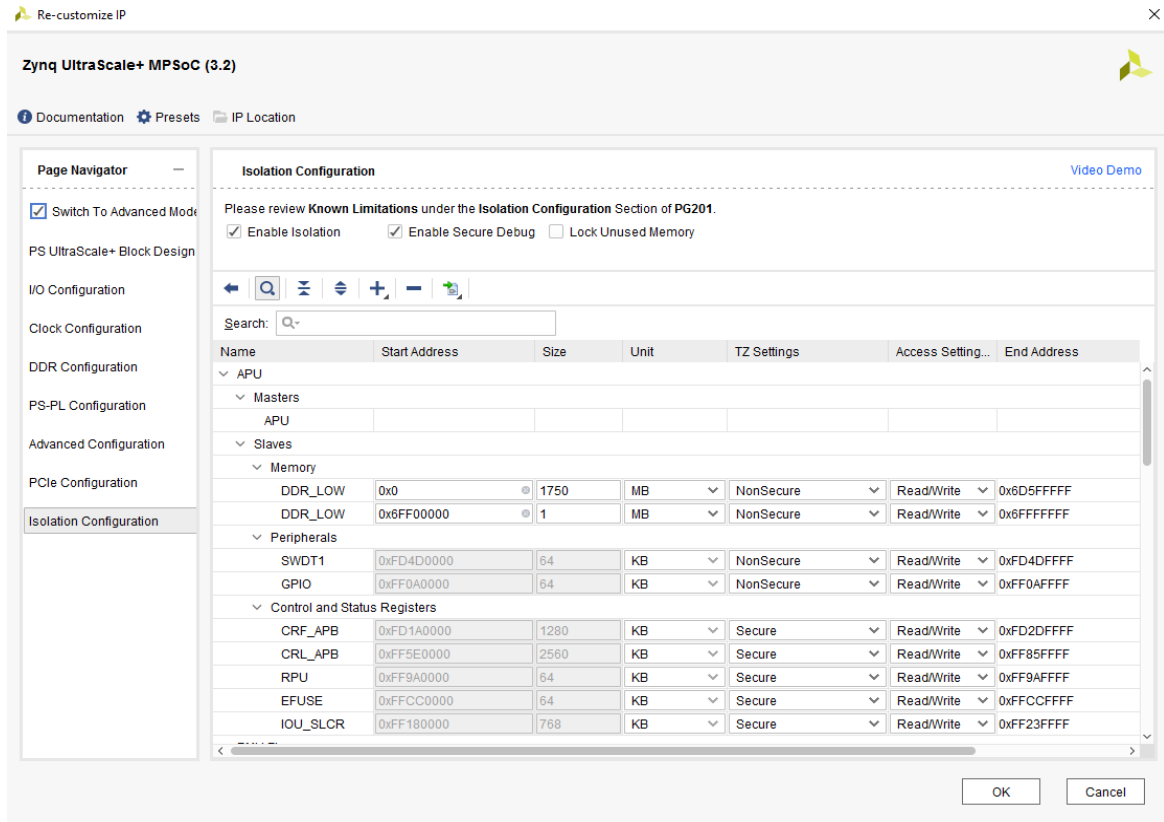

Figure 2-10: Isolation Configuration Registers for APU

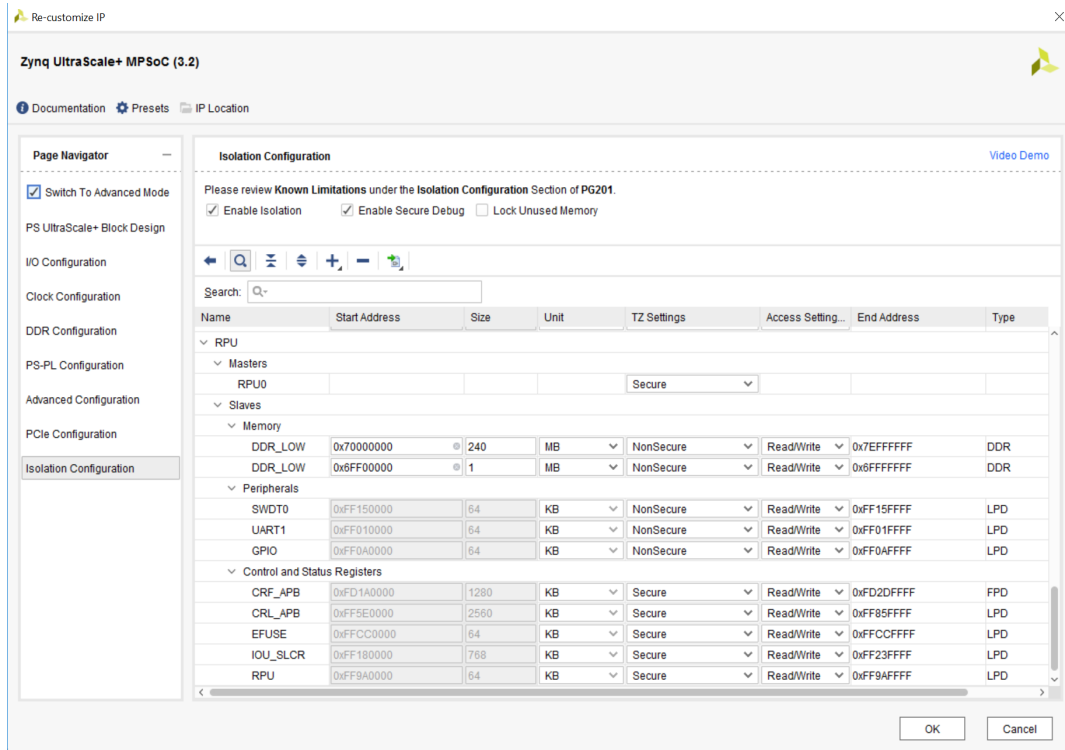

Figure 2-11: Isolation Configuration Registers for RPU

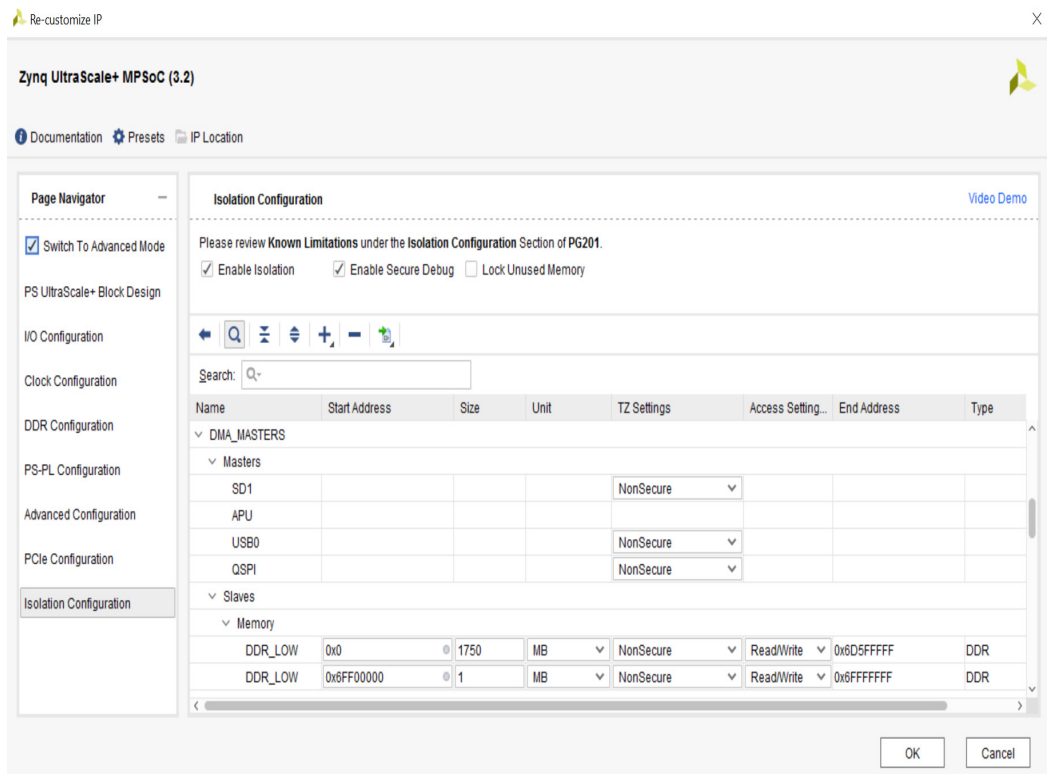

Figure 2-12: Isolation Configuration Registers for DMA_Masters

11. Click **OK** to close the Re-customize IP wizard.

Validating the Design and Connecting Ports

Use the following steps to validate the design:

1. Right-click in the white space of the Block Diagram view and select **Validate Design**. Alternatively, you can press the **F6** key.
2. A message dialog box opens and states "Validation successful. There are no errors or critical warnings in this design."
3. Click **OK** to close the message.
4. In the Block Design view, click the **Sources** tab.
5. Click **Hierarchy**.
6. Under **Design Sources**, right-click **edt_zcu102** and select **Create HDL Wrapper**.

The Create HDL Wrapper dialog box opens. You will use this dialog box to create a HDL wrapper file for the processor subsystem.



TIP: The HDL wrapper is a top-level entity required by the design tools.

7. Select **Let Vivado manage wrapper and auto-update** and click **OK**.
8. In the Block Diagram, Sources window, under **Design Sources**, expand **edt_zcu102_wrapper**.
9. Right-click the top-level block diagram, titled **edt_zcu102_i : edt_zcu102 (edt_zcu102.bd)** and select **Generate Output Products**.

The Generate Output Products dialog box opens, as shown in the following figure.

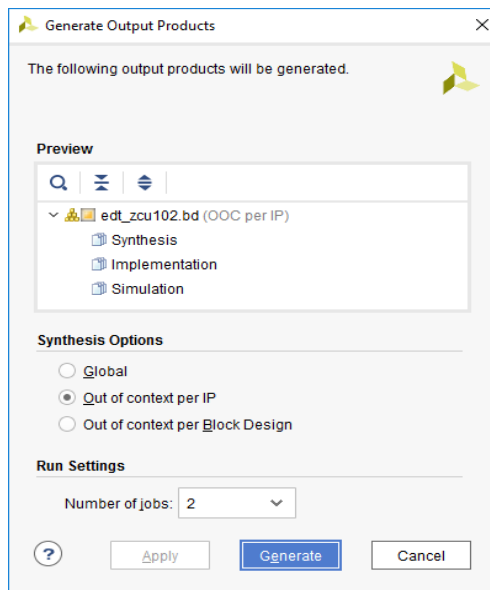

Figure 2-13: Generate Output Products Dialog Box

Note: If you are running the Vivado Design Suite on a Linux host machine, you might see additional options under Run Settings. In this case, continue with the default settings.

10. Click **Generate**.

This step builds all required output products for the selected source. For example, constraints do not need to be manually created for the IP processor system. The Vivado tools automatically generate the XDC file for the processor subsystem when **Generate Output Products** is selected.

11. Click **OK**, if you see the message: "Out-of-context module run was launched for generating output products".

12. When the Generate Output Products process completes, click **OK**.

- In the Block Diagram Sources window, click the **IP Sources** tab. Here you may see the output products that you just generated, as shown in the following figure.

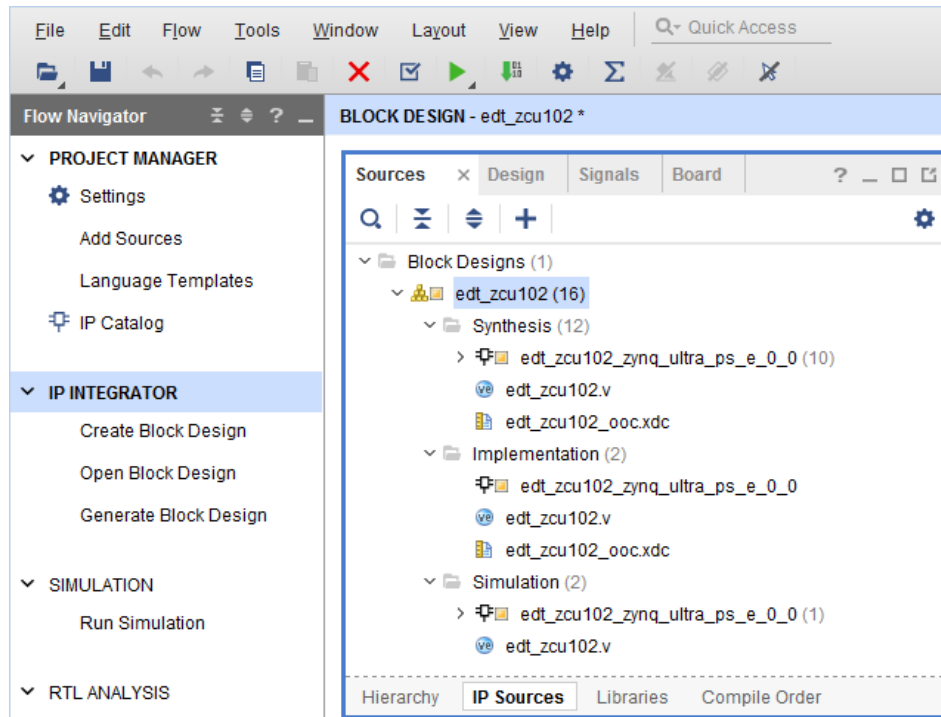

Figure 2-14: Outputs Generated Under IP Sources

Exporting Hardware to SDK

In this example, you will launch SDK from Vivado.

- Select **File > Export > Export Hardware**.

The Export Hardware dialog box opens. Make sure that the **Export to** field is set to the default option of **<Local to Project>**.

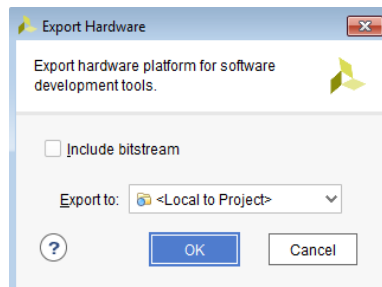

Figure 2-15: Export Hardware to SDK

- Click **OK**.



TIP: The hardware is exported in a ZIP file (<project wrapper>.hdf). When SDK launches, the file unzips automatically, and you can find all the files in the SDK project hardware platform folder.

3. Select **File > Launch SDK**.

The Launch SDK dialog box opens.



TIP: You can also start SDK in standalone mode and use the exported hardware. To do this, start SDK, and while creating a new project, point to the new target hardware that was exported.

4. Accept the default selections for **Exported location** and **Workspace**.

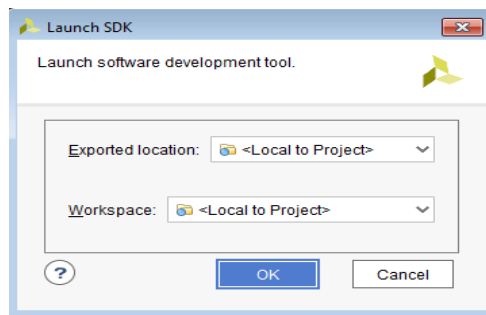

Figure 2-16: Launch SDK Dialog Box

5. Click **OK**.

SDK opens. Notice that when SDK launches, the hardware description file is loaded automatically.

The `system.hdf` tab shows the address map for the entire Processing System, as shown in the following figure.

system.hdf

edt_zcu102_wrapper_hw_platform_0 Hardware Platform Specification

Design Information

Target FPGA Device: xczu9eg
 Part: xczu9eg-ffvb1156-2-i
 Created With: Vivado
 Created On:

Address Map for processor psu_cortexa53_[0-3]

Cell	Base Addr	High Addr	Slave I/f	Mem/Reg	Segment	TrustZone	AccessType
psu_gdma_1	0xfd510000	0xfd51ffff		REGISTER		NonSecure	Read/Write
psu_gdma_2	0xfd520000	0xfd52ffff		REGISTER		NonSecure	Read/Write
psu_gdma_3	0xfd530000	0xfd53ffff		REGISTER		NonSecure	Read/Write
psu_crf_apb	0xfd1a0000	0xfd2dffff		REGISTER		NonSecure	Read/Write
psu_gdma_4	0xfd540000	0xfd54ffff		REGISTER		NonSecure	Read/Write
psu_gdma_5	0xfd550000	0xfd55ffff		REGISTER		NonSecure	Read/Write
psu_gdma_6	0xfd560000	0xfd56ffff		REGISTER		NonSecure	Read/Write
psu_gdma_7	0xfd570000	0xfd57ffff		REGISTER		NonSecure	Read/Write
psu_pcie_dma	0xfd0f0000	0xfd0fffff		REGISTER		NonSecure	Read/Write
psu_pmu_global_0	0xffd80000	0xffdbffff		REGISTER		NonSecure	Read/Write
psu_smmu_gpv	0xfd800000	0xfdffffff		REGISTER		NonSecure	Read/Write
psu_qspi_0	0xff0f0000	0xff0fffff		REGISTER		NonSecure	Read/Write
psu_siou	0xfd3d0000	0xfd3dffff		REGISTER		NonSecure	Read/Write
psu_smmu_reg	0xfd5f0000	0xfd5fffff		REGISTER		NonSecure	Read/Write
psu_sd_1	0xff170000	0xff17ffff		REGISTER		NonSecure	Read/Write

Overview

Figure 2-17: Address Map in SDK system.hdf Tab

What Just Happened?

Vivado exported the hardware specifications to the selected workspace where software development will take place. If **<Local to Project>** was selected, then Vivado created a new workspace in the Vivado project folder. The name of the workspace is `<project_name>.sdk`. In this example, the workspace created is `C:\edt\edt_zcu102\edt_zcu102.sdk`.

The Vivado design tool exported the Hardware Platform Specification for your design (`system.hdf` in this example) to SDK. In addition to `system.hdf`, the following additional files are exported to SDK:

- `psu_init.c`
- `psu_init.h`
- `psu_init.tcl`
- `psu_init_gpl.c`
- `psu_init_gpl.h`
- `psu_init.html`

The `system.hdf` file opens by default when SDK launches. The address map of your system read from this file is shown by default in the SDK window.

The `psu_init.c`, `psu_init.h`, `psu_init_gpl.c`, and `psu_init_gpl.h` files contain the initialization code for the Zynq UltraScale+ MPSoC Processing System and initialization settings for DDR, clocks, phase-locked loops (PLLs), and IOs. SDK uses these settings when initializing the processing system so that applications can be run on top of the processing system. Some settings in the processing system are fixed for the ZCU102 evaluation board.

What's Next?

Now, you can start developing the software for your project using SDK. The next sections help you create a software application for your hardware platform.

Example Project: Running the “Hello World” Application from Arm Cortex-A53

In this example, you will learn how to manage the board settings, make cable connections, connect to the board through your PC, and run a simple hello world software application from Arm Cortex-A53 in JTAG mode using System Debugger in Xilinx SDK.

1. Connect the power cable to the board.
2. Connect a USB Micro cable between the Windows Host machine and J2 USB JTAG connector on the Target board.
3. Connect a USB micro cable to connector J83 on the target board with the Windows Host machine. This is used for USB to serial transfer.



IMPORTANT: *Ensure that SW6 Switch is set to JTAG boot mode as shown in the following figure.*

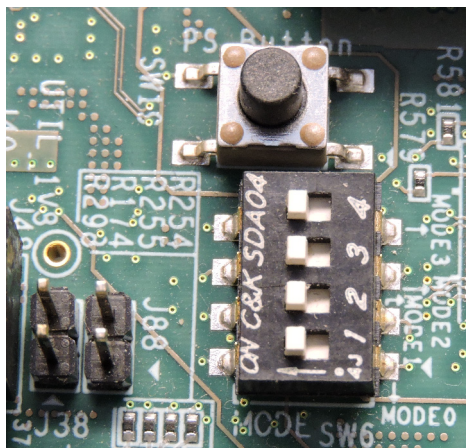

Figure 2-18: SW6 Switch Settings for JTAG Boot Mode

4. Power on the ZCU102 board using the switch indicated in the figure below.

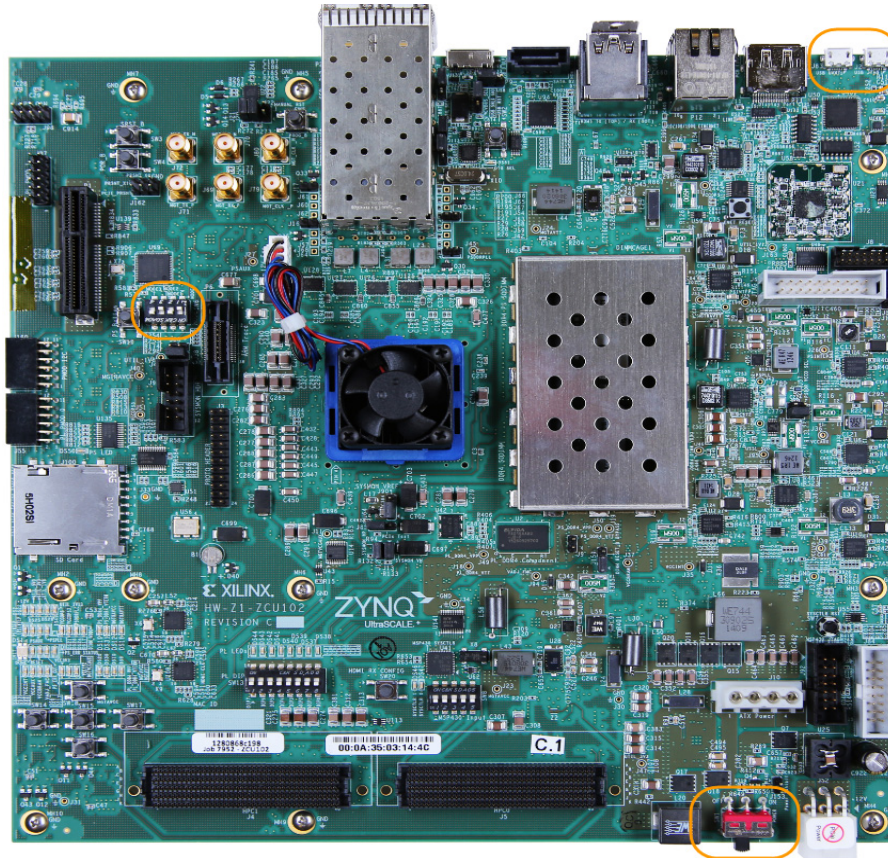



Figure 2-19: ZCU102 Board Power Switch

Note: If SDK is already running, jump to step 6.

5. Open SDK and set the workspace path to your project file, which in this example is `C:\edt\edt_zcu102\edt_zcu102.sdk`.

Alternately, you can open SDK with a default workspace and later switch it to the correct workspace by selecting **File > Switch Workspace** and then selecting the workspace.

6. Open a serial communication utility for the COM port assigned on your system. SDK provides a serial terminal utility, which will be used throughout the tutorial; select **Window > Show View > Other > Terminal** to open it.
7. Click the **Connect** button  to set the serial configuration and connect it.

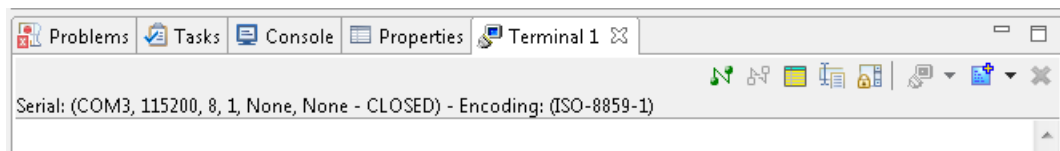



Figure 2-20: Terminal Window Header Bar

8. To modify, disconnect the connection by clicking the **Disconnect** button.

9. Click the **Settings** button  to open the Terminal Settings dialog box.
10. Verify the port details in the device manager.

UART-0 terminal corresponds to COM port with Interface-0. For this example, UART-0 terminal is set by default, so for the COM port, select the port with interface-0.

The following figure shows the standard configuration for the Zynq UltraScale+ MPSoC Processing System.

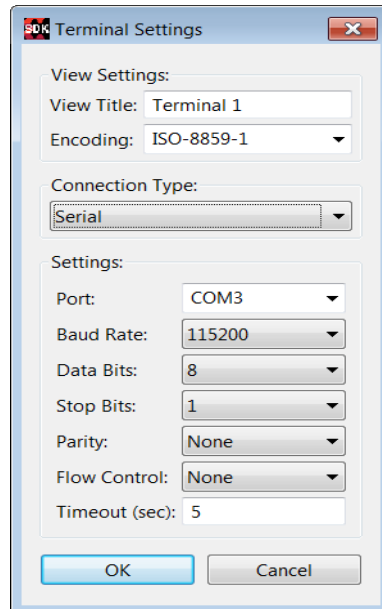

Figure 2-21: Terminal Settings Dialog Box

11. Select **File > New > Application Project**.

The new Project wizard opens.

12. Use the information in the table below to make your selections in the wizard screens.

Table 2-3: New Application Project Settings for Standalone APU Application

Wizard Screen	System Properties	Setting or Command to Use
Application Project	Project Name	test_a53
	Use Default Location	Select this option
	OS Platform	standalone
	Hardware Platform	edt_zcu102_wrapper_hw_platform_0
	Processor	psu_cortexa53_0
	Language	C
	Compiler	64-bit
	Hypervisor Guest	No
	Board Support Package	Select Create New and provide the name of test_a53_bsp.
Templates	Available Templates	Hello World

SDK creates the test_a53 application project and test_a53_bsp board support package (BSP) project under the Project Explorer. It automatically compiles both and creates the ELF file.

13. Right-click **test_a53** and select **Run as > Run Configurations**.

14. Right-click **Xilinx C/C++ application (System Debugger)** and click **New**.

SDK creates the new run configuration, named test_a53 Debug.

The configurations associated with the application are pre-populated in the Main tab of the launch configurations.

15. Click the **Target Setup** tab and review the settings.

Notice that there is a configuration path to the initialization Tcl file. The path of psu_init.tcl is mentioned here. This file was exported when you exported your design to SDK; it contains the initialization information for the processing system.

16. Power cycle the board.

17. Click **Run**.

"Hello World" appears on the serial communication utility in Terminal 1, as shown in the following figure.

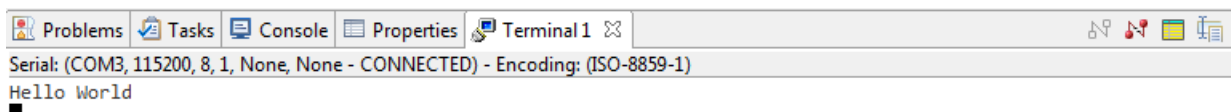

Figure 2-22: Output on Serial Terminal

Note: There was no bitstream download required for the above software application to be executed on the Zynq UltraScale+ evaluation board. The Arm Cortex A53 quad core is already present in the processing system. Basic initialization of this system to run a simple application is done by the Device initialization Tcl script.

18. Power cycle the board and retain same connections and board settings for the next section.

What Just Happened?

The application software sent the "Hello World" string to the UART0 peripheral of the PS section.

From UART0, the "Hello world" string goes byte-by-byte to the serial terminal application running on the host machine, which displays it as a string.

Additional Information

Board Support Package

The board support package (BSP) is the support code for a given hardware platform or board that helps in basic initialization at power up and helps software applications to be run on top of it. It can be specific to some operating systems with bootloader and device drivers.



TIP: If you would like to regenerate the BSP, right click the BSP project under the Project Explorer and select **Re-generate BSP Sources**.

If you would like to change the target BSP after project creation:

1. Create a **New Board Support Package** for your target.
2. In the Project Explorer, right click your application project and select **Change Referenced BSP**, and point the new BSP you want to set.

Standalone OS

Standalone is a simple, low-level software layer. It provides access to basic processor features such as caches, interrupts, and exceptions, as well as the basic processor features of a hosted environment. These basic features include standard input/output, profiling, abort, and exit. It is a single threaded semi-hosted environment.



IMPORTANT: *The application you ran in this chapter was created on top of the Standalone OS. The BSP that your software application targets is selected during the New Application Project creation process. If you would like to change the target BSP after project creation, you can manage the target BSP by right-clicking the software application and selecting **Change Referenced BSP**.*

Build Software for PS Subsystems

This chapter lists the steps to configure and build software for PS subsystems. In this chapter, you will use the Zynq® UltraScale™+ hardware platform (hardware definition file) configured in the Vivado® Design Suite.

In [Chapter 2](#), you created and exported the hardware platform from Vivado. This hardware platform contains the hardware handoff file, the processing system initialization files (`psu_init`), and the PL bitstream. In this chapter, you will use the hardware platform in Xilinx® SDK and Petalinux to configure software for the processing system.

This chapter serves two important purposes. One, it helps you build and configure the software components that can be used in future chapters. Second, it describes the build steps for a specific PS subsystem.

Processing Units in Zynq UltraScale+

The main processing units in the processing system in Zynq UltraScale+™ are listed below.

- Application Processing Unit: Quad-core Arm® Cortex®-A53 MPCore Processors
- Real Time Processing Unit: Dual-core Arm Cortex-R5 MPCore Processors
- Graphics Processing Unit: Arm Mali 400 MP2 GPU
- Platform Management Unit (PMU)

This section demonstrates configuring these units using system software. This can be achieved either at the boot level using First Stage Boot Loader (FSBL) or via system firmware, which is applicable to the platform management unit (PMU).

You will use the Zynq UltraScale+ hardware platform in SDK to perform the following tasks:

1. Create a First Stage Boot Loader (FSBL) for the Arm Cortex-A53 64-bit quad-core processor unit (APU) and the Cortex-R5 dual-core real-time processor unit (RPU).
2. Create bare-metal applications for APU and RPU.
3. Create platform management unit (PMU) firmware for the platform management unit using Xilinx SDK.

In addition to the bare-metal applications, this chapter also describes building U-Boot and Linux Images for the APU. The Linux images and U-Boot can be configured and built using the PetaLinux build system.

Example Project: Create a Bare-Metal Application Project in SDK

For this example, you will launch Xilinx SDK and create a bare-metal application using the hardware platform for Zynq UltraScale+ created using the Vivado Design Suite. [Figure 3-1, page 38](#) shows the SDK New Application Project dialog box and possible options for creating bare-metal (Standalone) applications for processing subsystems in Zynq UltraScale+ devices.

Create First Stage Boot Loader for Arm Cortex-A53-Based APU

Start with creating the First Stage Boot Loader (FSBL). Zynq UltraScale+ supports the FSBL to run on either the APU or the RPU. This way, you can load the FSBL on the required Arm processor, and the FSBL will then subsequently load the required application or secondary boot loader on the required core.

In this example, you will create an FSBL image targeted for Arm Cortex-A53 core 0.

1. Start SDK if it is not already open.
2. Set the Workspace path based on the project you created in Chapter 2. For example, `C:\edt\edt_zcu102\edt_zcu102.sdk`.
3. Select **File > New > Application Project**.

The New Project dialog box opens.

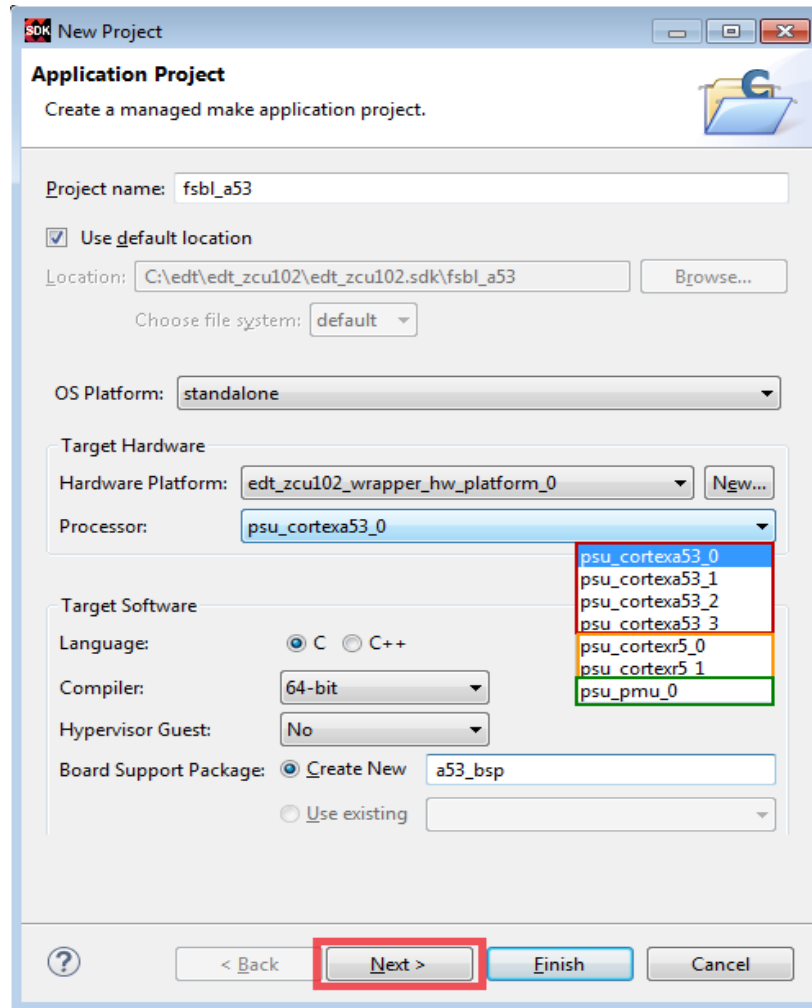

Figure 3-1: Application Project Page of New Project Wizard

- Use the information in the following table to make your selections in the New Project wizard:

Table 3-1: Settings to Create New Application Project - FSBL_A53

Wizard Screen	System Properties	Setting or Command
Application Project	Project Name	fsbl_a53
	Use Default Location	Select this option
	OS Platform	Standalone
	Hardware Platform	edt_zcu102_wrapper_hw_platform_0
	Processor	psu_cortexa53_0
	Language	C
	Compiler	64-bit
	Hypervisor Guest	No
Board Support Package	Select Create New and provide the name of a53_bsp.	

Table 3-1: Settings to Create New Application Project - FSBL_A53 (Cont'd)

Wizard Screen	System Properties	Setting or Command
Click Next		
Templates	Available Templates	Zynq MP FSBL

5. In the Templates page, select **Zynq MP FSBL**:

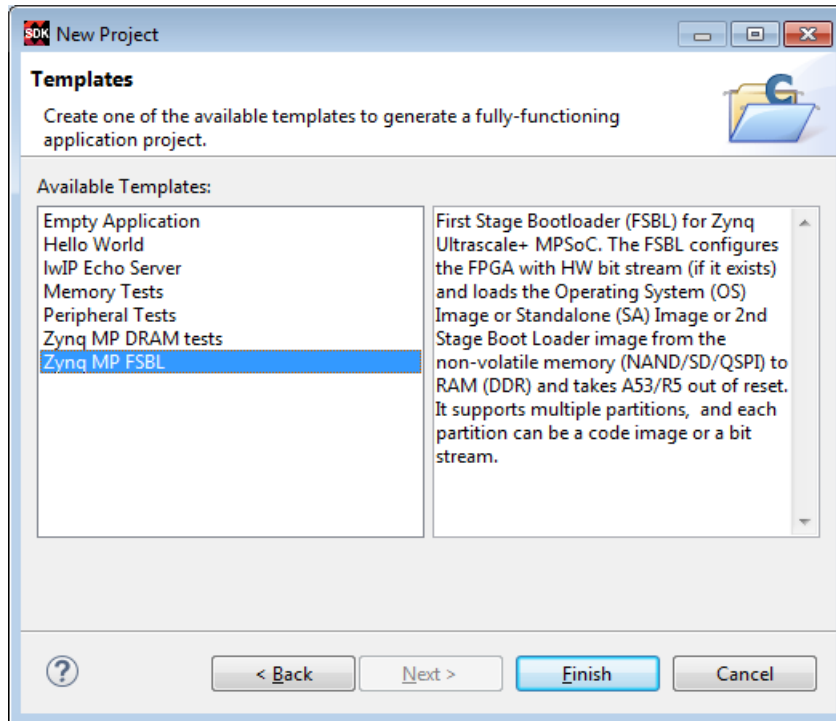

Figure 3-2: Templates Page of the New Project Wizard

6. Click **Finish**.

SDK creates the board Support package and an FSBL application.

By default, the FSBL is configured to show basic print messages. Next, you will modify the FSBL build settings to enable debug prints.

For a list of the possible debug options for FSBL, refer to the `fsbl_a53 > src > xfsbl_debug.h` file.

For this example, enable FSBL_DEBUG_INFO by doing the following:

1. In the **Project Explorer** folder, right-click the **fsbl_a53** application.
2. Click **C/C++ Build Settings**.
3. Select **Settings > Tool Settings > Symbols**.
4. Click the **Add** button .
5. Enter FSBL_DEBUG_INFO.

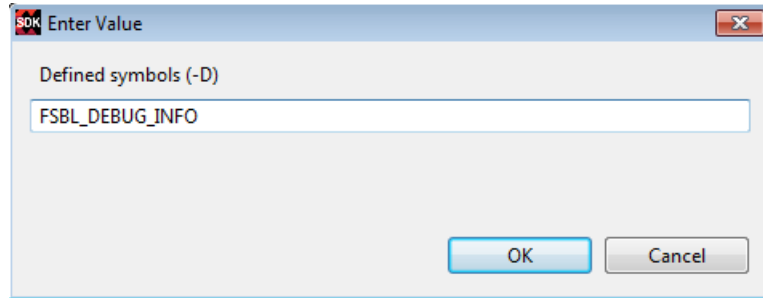

Figure 3-3: Enter Value Dialog Box

The Symbols settings are as shown in the following figure.

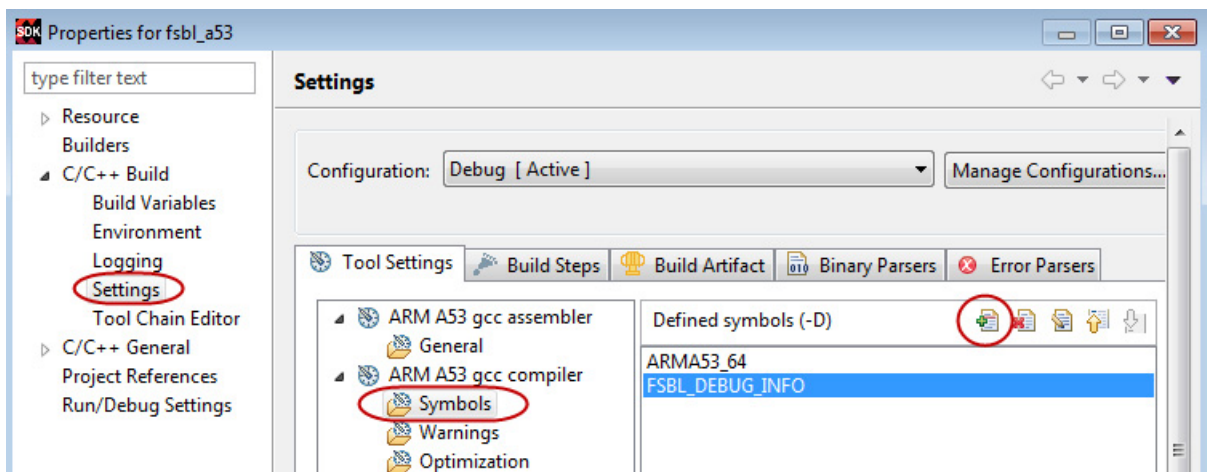

Figure 3-4: Symbols Settings for fsbl_a53 Application

6. Click **OK** to accept the changes and close the Settings dialog box.
7. Right-click the `fsbl_a53` application and select **Clean Project**.

Note: If the **Project > Build Automatically** setting is selected, SDK automatically builds the application for you.
8. The FSBL executable is now saved as `fsbl_a53 > debug > fsbl_a53.elf`.

In this tutorial, the application name `fsbl_a53` is to identify that the FSBL is targeted for APU (the Arm Cortex-A53 core).

9. Save the file, and re-build the fsbl_a53 application.

Note: If the system design demands, the FSBL can be targeted to run on RPU, which can then load rest of the software stack on RPU and APU.

Create First Stage Boot Loader for Arm Cortex-R5 Based RPU

You can also create an FSBL for Arm Cortex-R5 Core by doing the following.

1. Click **File > New > Application Project** to open the New Project dialog box.

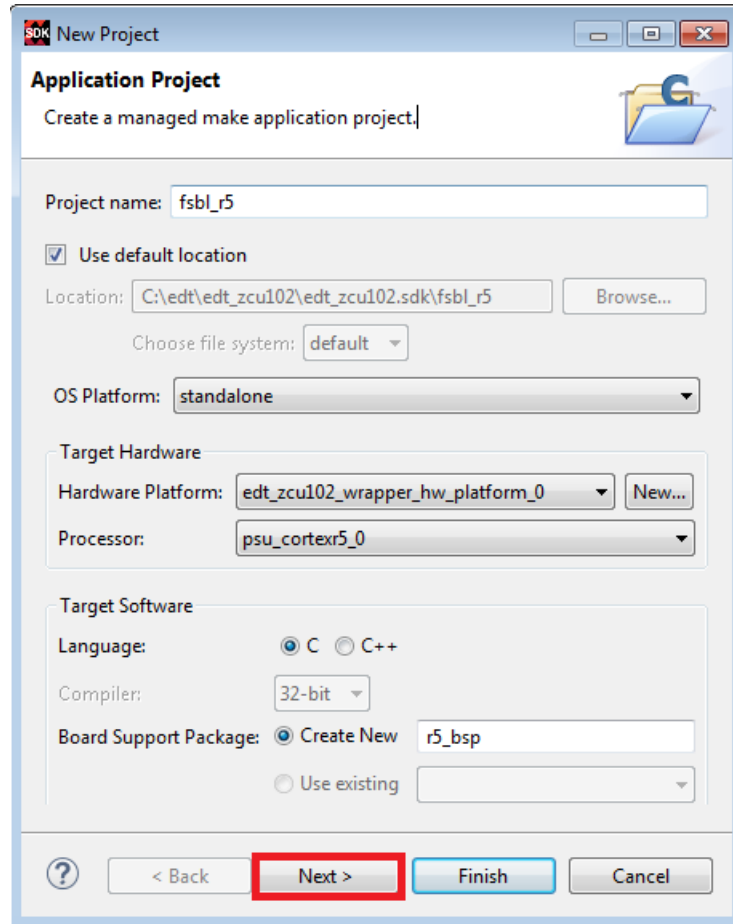

Figure 3-5: Application Project Page of New Project Wizard

2. Use the information in the following table to make your selections in the New Project wizard.

Table 3-2: Settings to Create New Application Project - FSBL_R5

Wizard Screen	System Properties	Setting or Command
Application Project	Project Name	fsbl_r5
	Use Default Location	Select this option
	OS Platform	Standalone
	Hardware Platform	edt_zcu102_wrapper_hw_platform_0
	Processor	psu_cortexr5_0
	Language	C
	Board Support Package	Select Create New and provide the name of r5_bsp.
Click Next		
Templates	Available Templates	Zynq MP FSBL

3. Click **Finish**.

This creates the board Support package and an FSBL application targeted for RPU Arm Cortex--R5 Core 0 in Zynq UltraScale+.

Create Bare-Metal Application for Arm Cortex-A53 based APU

Now that the FSBL is created, you will now create a simple bare-metal application targeted for an Arm A53 Core 0.

For this example, you will use the test_a53 application that you created in [Example Project: Running the "Hello World" Application from Arm Cortex-A53 in Chapter 2](#)

In test_a53, you selected a simple Hello World application. This application can be loaded on APU by FSBL running on either APU or RPU.

SDK also provides few other bare-metal applications templates to make it easy to start running applications on Zynq UltraScale+ devices. Alternatively, you can also select the Empty Application template and copy or create your custom application source code in the application folder structure.

Modify the Application Source Code

1. In the Project Explorer, click `test_a53 > src > helloworld.c`.

This opens the `helloworld.c` source file for the `test_a53` application.

2. Modify the arguments in the `print` command, as shown below.

```
Print("Hello World from APU\n\r");

int main()
{
    init_platform();
    print("Hello World from APU\n\r");
    cleanup_platform();
    return 0;
}
```

Figure 3-6: Application Source Code Snippet: Print Command

3. Type **Ctrl + S** to save the changes.
4. Right-click the `test_a53` project and select **Build Project**.
5. Verify that the application is compiled and linked successfully and the `test_a53.elf` file is generated in the `test_a53 > Debug` folder.

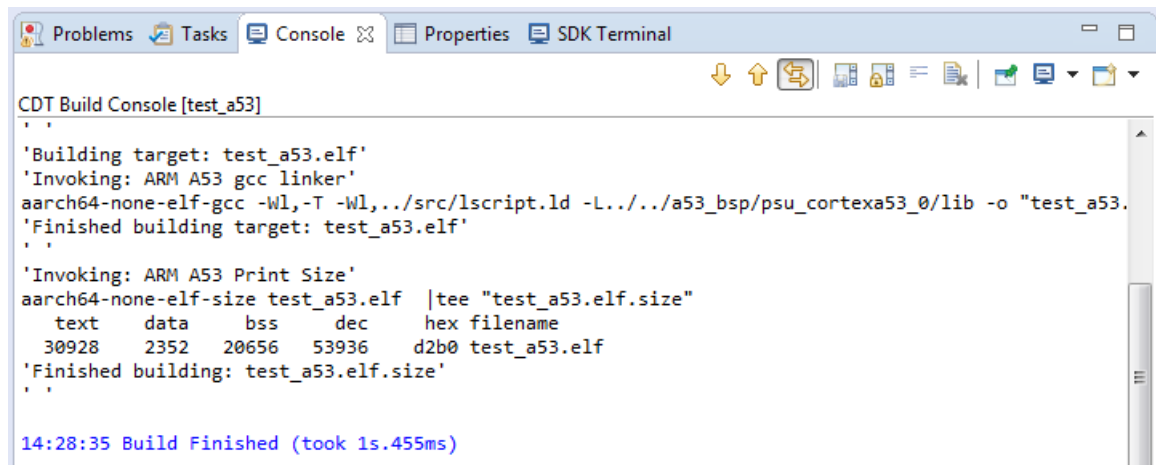

Figure 3-7: CDT Build Console

Create Bare-Metal Application for Arm Cortex-R5 based RPU

In this example, you will create a bare-metal application project for Arm Cortex-R5 based RPU. For this project, you will need to import the application source files available in the Design Files ZIP file released with this tutorial. For information about locating these design files, refer to [Design Files for This Tutorial in Appendix B](#).

Creating the Application Project

1. In SDK, select **File > New > Application Project** to open the New Project wizard.
2. Use the information in the following table to make your selections in the wizard.

Table 3-3: Settings to Create New RPU Application Project

Wizard Screen	System Properties	Setting or Command to Use
Application Project	Project Name	testapp_r5
	Use Default Location	Select this option
	OS Platform	standalone
	Hardware Platform	edt_zcu102_wrapper_hw_platform
	Processor	psu_cortexr5_0
	Language	C
	Board Support Package	Select Use Existing and select r5_bsp
Templates	Available Templates	Empty Application

Note: The `r5_bsp` board support package was created when you followed the steps in [Create First Stage Boot Loader for Arm Cortex-R5 Based RPU](#).

3. Click **Finish**.

The New Project wizard closes and SDK creates the **testapp_r5** application project, which can be found in the Project Explorer.

4. In the Project Explorer tab, expand the **testapp_r5** project.
5. Right-click the **src** directory, and select **Import** to open the Import dialog box.
6. Expand **General** in the Import dialog box and select **File System**.
7. Click **Next**.
8. Select **Browse** and navigate to the design files folder, which you saved earlier (see [Design Files for This Tutorial in Appendix B](#)).
9. Click **OK**.
10. Select the `testapp.c` file.
11. Click **Finish**. SDK automatically builds the application and displays the status in the console window.
12. Open `testapp.c` to review the source code for this application. The application configures the UART interrupt and sets the Processor to WFI mode. This application is reused and explained during run time in [Chapter 5, Boot and Configuration](#).

Modifying the Linker Script

Note: This section is optional, to describe how the Linker Script can be modified to configure different memory attributes for the application. This is optional for this tutorial as these settings are already taken care by the isolation created [Chapter 2](#) of this tutorial. The Linker script helps create software boundaries, while the Isolation configuration based on XMPU provides hardware protection against any illegal access to protected regions.

1. In the Project Explorer, expand the **testapp_r5** project.

2. In the `src` directory, double-click `lscript.ld` to open the linker script for this project.
3. In the linker script, change the application Memory Regions (except the vectors section) to `psu_r5_ddr_0_MEM_3` which has below base address and size.:
 - **Base Address:** `0x7F000000`
 - **Size:** `0xF00000`

The linker script modification is shown in following figure. The following figure is for representation only. The actual memory regions may vary based on the Isolation settings.

Linker Script: lscript.ld

A linker script is used to control where different sections of an executable are placed in memory. In this page, you can define new memory regions, and change the assignment of sections to memory regions.

Available Memory Regions

Name	Base Address	Size	
psu_ocm_ram_0_MEM_0	0xFFFC0000	0x40000	
psu_qspi_linear_0_MEM_0	0xC0000000	0x20000000	
psu_r5_0_atcm_MEM_0	0x0	0x10000	
psu_r5_0_btcm_MEM_0	0x20000	0x10000	
psu_r5_ddr_0_MEM_0	0x6FF00000	0x100000	
psu_r5_ddr_0_MEM_1	0x70000000	0xF000000	
psu_r5_ddr_0_MEM_2	0x6D600000	0x2900000	
psu_r5_ddr_0_MEM_3	0x7F000000	0xF00000	
psu_r5_tcm_ram_0_MEM_0	0x0	0x40000	

Stack and Heap Sizes

Stack Size:

Heap Size:

Figure 3-8: Linker Script Modification

This modification in the linker script ensures that the RPU bare-metal application resides above `0x7F000000` base address in the DDR, and occupies no more than 16 MB of size.

4. Type **Ctrl + S** to save the changes.
5. Right-click the `testapp_r5` project and select **Build Project**.
6. Verify that the application is compiled and linked successfully and that the `testapp_r5.elf` file was generated in the `testapp_r5 > Debug` folder.

Modifying the Board Support Package

The ZCU102 Evaluation kit has a USB-TO-QUAD-UART Bridge IC from Silicon Labs (CP2108). This enables you to select a different UART port for applications running on A53 and R5 Cores. For this example, let A53 use the UART 0 by default, and send and receive RPU serial data over UART 1. This requires a small modification in the `r5_bsp` file.

1. Right-click `r5_bsp` and select **Board Support Package Settings**.
2. Click **Standalone**.
3. Modify the `stdin` and `stdout` values to `psu_uart_1`, as shown in the figure below.

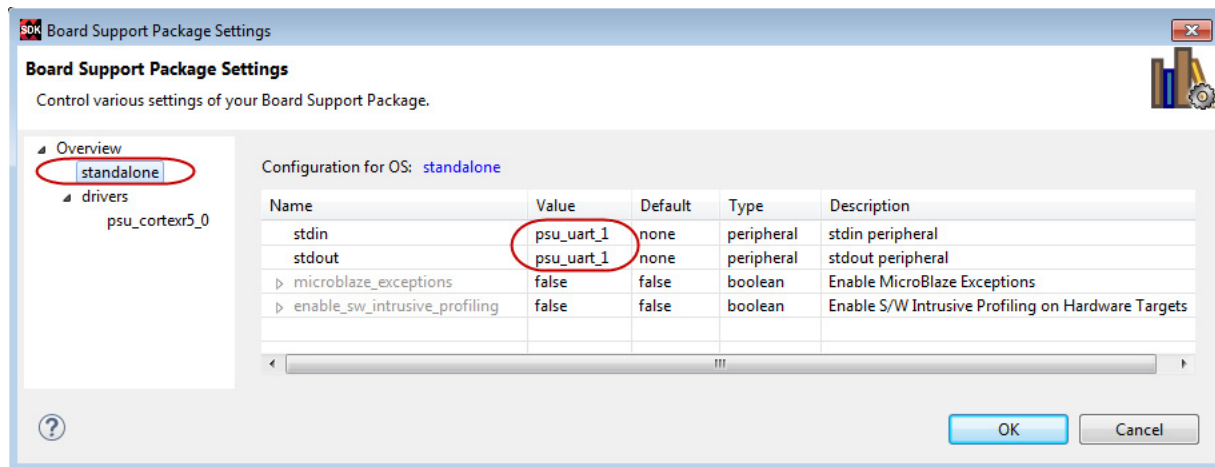

Figure 3-9: Board Support Package Settings for RPU BSP

4. Click **OK**.
5. Right-click the `testapp_r5` project and select **Build Project**.
6. Verify that the application is compiled and linked successfully and that the `testapp_r5.elf` was generated in the `testapp_r5 > Debug` folder.

Create PMU Firmware for Platform Management Unit

In this example, you will create PMU firmware using Xilinx SDK. PMU firmware plays an important role in boot-up and overall platform management of Zynq UltraScale+ MPSoC. For more information, see [Platform Management Unit Firmware in Chapter 5](#).

1. Select **File > New > Application Project**.
2. In the application dialog box, enter Project name `pmu_fw`.
3. Leave the **Use default location** check box selected.
4. For the OS Platform, select **Standalone**.
5. In the Target Hardware area, do the following:
 - a. Ensure that the hardware platform exported from Vivado in [Chapter 2](#), `edt_zcu102_wrapper_hw_platform_0`, is selected as the Hardware Platform.
 - b. For the processor, select **psu_pmu_0**.
6. In the Target Software area, do the following:

- a. Select the **C** Language.
 - b. Under **Board Support Package**, select **Create New** and enter **pmu_bsp**.
7. Click **Next**.
 8. Select the **ZynqMP PMU Firmware**.
 9. Click **Finish**.

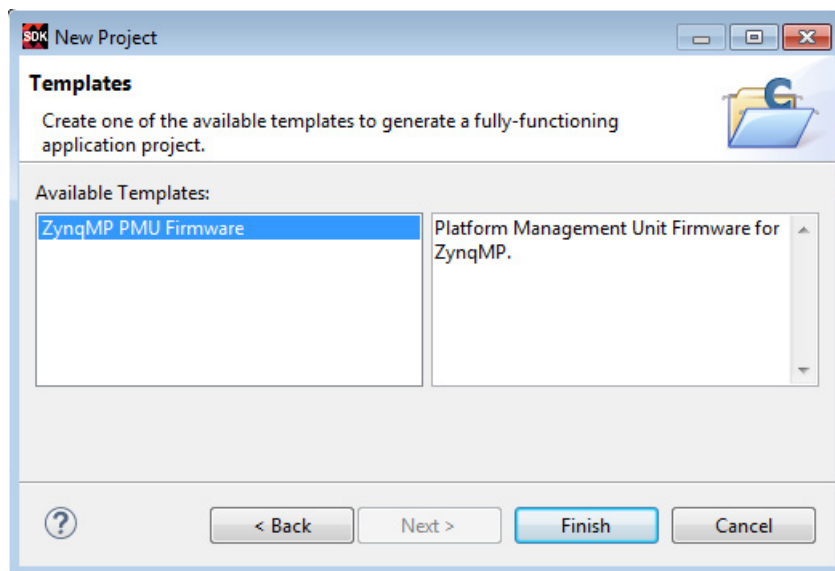

Figure 3-10: Templates Page of the New Project Dialog Box

10. Verify that the firmware was compiled and linked successfully to generate the executable in `pmu_fw > Debug > pmu_fw.elf`.

Example Project: Create Linux Images using PetaLinux

The earlier example highlighted creation of the bootloader images and bare-metal applications for APU, RPU, and PMU using Xilinx SDK. In this chapter, you will configure and build Linux Operating System Platform for Arm Cortex A53 core based APU on Zynq UltraScale+. The PetaLinux tool flow, along with the board-specific BSP, can be used to configure and build Linux images.



IMPORTANT: This example needs a Linux Host machine. *PetaLinux Tools Documentation: Reference Guide (UG1144) [Ref 7]* for information about dependencies for PetaLinux 2018.2.



IMPORTANT: This example uses the ZCU102 PetaLinux BSP to create a PetaLinux project. Ensure that you have downloaded the ZCU102 BSP for PetaLinux as instructed in *PetaLinux Tools, page 11*.

1. Create a PetaLinux project using the following command:

```
$petalinux-create -t project -s <xilinx-zcu102-v2018.2-final.bsp>
```

Note: `xilinx-zcu102-v2018.2-final.bsp` is the PetaLinux BSP for ZCU102 Production Silicon Rev1.0 Board. Use `xilinx-zcu102-ZU9-ES2-Rev1.0-v2018.2-final.bsp`, if you are using ES2 Silicon on Rev 1.0 board.

The above step creates a PetaLinux Project Directory, such as:

```
xilinx-zcu102-2018.2.
```

2. Change to the PetaLinux project directory using the following command:

```
$ cd xilinx-zcu102-2018.2
```

The `ZCU102 PetaLinux-BSP` is the default ZCU102 Linux BSP. For this example, you reconfigure the PetaLinux Project based on the Zynq UltraScale+ hardware platform that you configured using Vivado Design Suite in [Chapter 2](#). This will help PetaLinux set device tree settings based on the [Isolation Configuration in Chapter 2](#).

3. Copy the hardware platform `edt_zcu102_wrapper.hdf` to the Linux Host machine.
4. Reconfigure the project using the following command:

```
$ petalinux-config --get-hw-description=<path containing edt_zcu102_wrapper.hdf>/
```

This command opens the PetaLinux Configuration window. If required, make changes in the configuration. For this example, the default settings from the BSP are sufficient to generate required boot images.

The following steps will verify if PetaLinux is configured to create Linux and boot images for SD Boot.

5. Select **Subsystem AUTO Hardware Settings**.
6. Select **Advanced Bootable Images Storage Settings**.
 - a. Select **boot image settings**.
 - b. Select **Image Storage Media**.
 - c. Select **primary sd** as the boot device.
7. Under the **Advanced Bootable Images Storage Settings** submenu, do the following:
 - a. Select **kernel image settings**.
 - b. Select **Image Storage Media**.
 - c. Select **primary sd** as the storage device.
8. Under **Subsystem AUTO Hardware Settings**, select **Memory Settings** and set the System Memory Size to **0x6D5FFFFF**
9. Save the configuration settings and exit the Configuration wizard.
10. Wait until PetaLinux reconfigures the project.

The following steps will build the Linux images, verify them, and generate the boot image.

11. Modify Device Tree to disable Heartbeat LED and SW19 push button, from the device tree. Due to this the RPU R5-0 can use PS LED and SW19 switch for other designs in this tutorial. This can be done by adding the following to the `system-user.dtsi` which can be found in the following location:

```
<PetaLinux-project>/project-spec/meta-user/recipes-bsp/device-tree/files/system-user.dtsi
```

12. Add the following to `system-user.dtsi`, so that it looks like:

```
/include/ "system-conf.dtsi"
/ {
    gpio-keys {
        sw19 {
            status = "disabled";
        };
    };
    leds {
        heartbeat_led {
            status = "disabled";
        };
    };
};
```

13. In `<PetaLinux-project>`, build the Linux images using the following command:

```
$ petalinux-build
```

14. After the above statement executes successfully, verify the images and the timestamp in the `images` directory in the PetaLinux project folder using the following commands:

```
$ cd images/linux/
$ ls -al
```

15. Generate the Boot image using the following command:

```
$ petalinux-package --boot --fsbl zynqmp_fsbl.elf --u-boot
```

This creates a `BOOT.BIN` image file in the following directory:

```
<petalinux-project>/images/linux/BOOT.BIN
```

The Logs indicate that the above command includes `PMU_FW` and `ATF` in `BOOT.BIN`. You can also add `--pmufw <PMUFW_ELF>` and `--atf <ATF_ELF>` in the above command. Refer `$ petalinux-package --boot --help` for more details.

Note: The option to add bitstream, that is `--fpga` is missing from above command intentionally. This is because the hardware configuration so far is only based on PS with no design in PL. In case a bitstream is present in the design, `--fpga` can be added in the `petalinux-package` command as shown below:

```
petalinux-package --boot --fsbl zynqmp_fsbl.elf --fpga system.bit --pmufw pmufw.elf
--atf bl31.elf --u-boot u-boot.elf
```

Verify the Image on the ZCU102 Board

To verify the image:

1. Copy files `BOOT.BIN` and `image.ub` to an SD card.
2. Load the SD card into the ZCU102 board, in the J100 connector.
3. Connect a Micro USB cable from ZCU102 Board USB UART port (J83), to USB port on the host Machine.
4. Configure the Board to Boot in SD-Boot mode by setting switch SW6 as shown in the following figure.

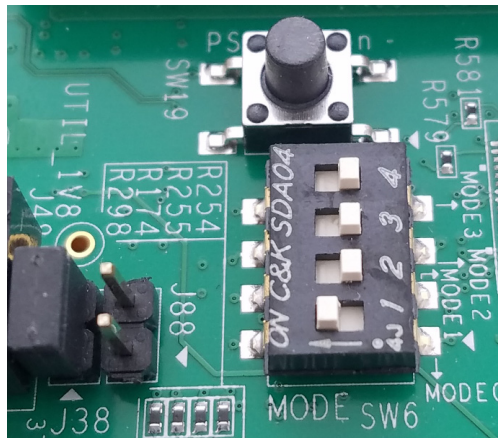

Figure 3-11: SW6 Switch Settings for SD Boot Mode

5. Connect 12V Power to the ZCU102 6-Pin Molex connector.
6. Start a terminal session, using Tera Term or Minicom depending on the host machine being used. set the COM port and baud rate for your system, as shown in the following figure.

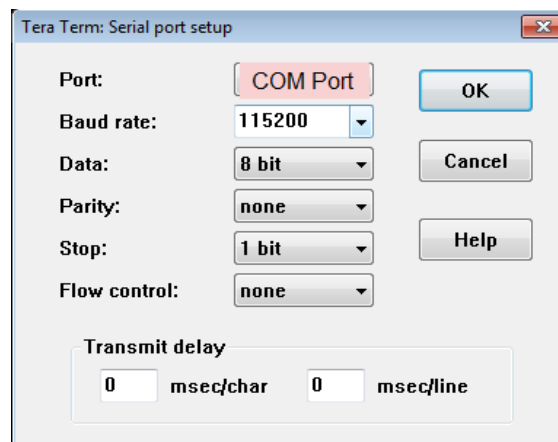

Figure 3-12: COM Port Set Up

7. For port settings, verify COM port in the device manager and select the COM port with interface-0.
8. Turn on the ZCU102 Board using SW1, and wait until Linux loads on the board.

Create Linux Images using PetaLinux for QSPI Flash

The earlier example highlighted creation of the Linux Images and Boot images to boot from an SD card. This section explains the configuration of PetaLinux to generate Linux images for QSPI flash. For more information about the dependencies for PetaLinux 2018.2, see the *PetaLinux Tools Documentation: Reference Guide* (UG1144) [Ref 7].

1. Before starting this example, create a backup of the boot images created for SD card setup using the following commands:

```
$ cd <Petalinux-project-path>/xilinx-zcu102-2018.2/images/linux/  
$ mkdir sd_boot  
$ cp image.ub sd_boot/  
$ cp u-boot.elf sd_boot/  
$ cp BOOT.BIN sd_boot/
```

2. Change the directory to the PetaLinux Project root directory:

```
$ cd <Petalinux-project-path>/xilinx-zcu102-2018.2
```

3. Launch the top level system configuration menu:

```
$ petalinux-config
```

The Configuration wizard opens.

4. Select **Subsystem AUTO Hardware Settings**.
5. Select **Advanced bootable images storage Settings**.
 - a. Select **boot image settings**.
 - b. Select **image storage media**.
 - c. Select **primary flash** as the boot device.
6. Under the **Advanced bootable images storage Settings** submenu, do the following:
 - a. Select **kernel image settings**.
 - b. Select **image storage media**.
 - c. Select **primary flash** as the storage device.
7. One level above, that is, under **Subsystem AUTO Hardware Settings**,
 - a. Select **Flash Settings** and notice the entries listed in the partition table.
 - b. Note that some memory (0x1E00000 + 0x40000) is set aside for initial Boot partitions and U-Boot settings. These values can be modified on need basis.

- c. Based on this, the offset for Linux Images is calculated as 0x1E40000 in QSPI Flash device. This will be used in Chapter 5, while creating Boot image for QSPI Boot-mode.

The following steps will set the Linux System Memory Size to about 1.79 GB.

8. Under **Subsystem AUTO Hardware Settings**, do the following:
 - a. Select **Memory Settings**
 - a. Set **System Memory Size** to **0x6D5FFFFF**
9. Save the configuration settings and exit the Configuration wizard.
10. Rebuild using the `petalinux-build` command.
11. Take a backup of `u-boot.elf` and the other images. These will be used in [Chapter 5](#).

Note: For more information, refer to the *PetaLinux Tools Documentation: Reference Guide* (UG1144) [\[Ref 7\]](#)

In this chapter, you learned how to configure and compile Software blocks for Zynq UltraScale+ devices using Xilinx tools. You will use these images in [Chapter 6](#) to create Boot images for a specific design example.

Next, you will debug software for Zynq UltraScale+ devices using Xilinx SDK in [Chapter 4, Debugging with SDK](#).

Debugging with SDK

This chapter describes debug possibilities with the design flow you have already been working with. The first option is debugging with software using the Xilinx® Software Development Kit (SDK).

SDK debugger provides the following debug capabilities:

- Supports debugging of programs on Arm® Cortex®-A53, Arm Cortex-R5, and MicroBlaze™ processor architectures (heterogeneous multi-processor hardware system debugging)
- Supports debugging of programs on hardware boards
- Supports debugging on remote hardware systems
- Provides a feature-rich IDE to debug programs
- Provides a Tool Command Language (Tcl) interface for running test scripts and automation

The SDK debugger enables you to see what is happening to a program while it executes. You can set breakpoints or watchpoints to stop the processor, step through program execution, view the program variables and stack, and view the contents of the memory in the system.

Xilinx SDK supports debugging through Xilinx System Debugger.

Xilinx System Debugger

The Xilinx System Debugger uses the Xilinx hw_server as the underlying debug engine. SDK translates each user interface action into a sequence of Target Communication Framework (TCF) commands. It then processes the output from System Debugger to display the current state of the program being debugged. It communicates to the processor on the hardware using Xilinx hw_server.

The debug workflow is described in the following figure.

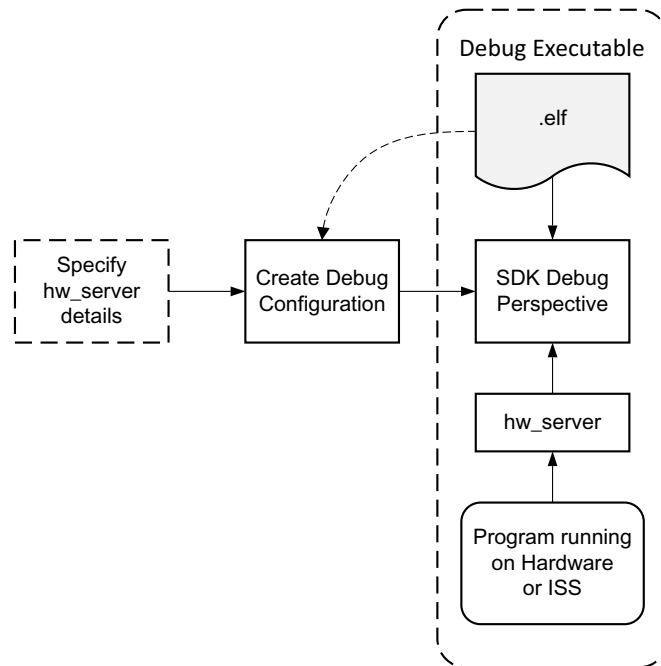

X16794-041816

Figure 4-1: System Debugger Flow

The workflow is made up of the following components:

- **Executable ELF File:** To debug your application, you must use an Executable and Linkable Format (ELF) file compiled for debugging. The debug ELF file contains additional debug information for the debugger to make direct associations between the source code and the binaries generated from that original source. To manage the build configurations, right-click the software application and select **Build Configurations > Manage**.
- **Debug Configuration:** To launch the debug session, you must create a debug configuration in SDK. This configuration captures options required to start a debug session, including the executable name, processor target to debug, and other information. To create a debug configuration, right-click your software application and select **Debug As > Debug Configurations**.
- **SDK Debug Perspective:** Using the Debug perspective, you can manage the debugging or running of a program in the Workbench. You can control the execution of your program by setting breakpoints, suspending launched programs, stepping through your code, and examining the contents of variables. To view the Debug Perspective, select **Window > Open Perspective > Debug**.

You can repeat the cycle of modifying the code, building the executable, and debugging the program in SDK.

Note: If you edit the source after compiling, the line numbering will be out of step because the debug information is tied directly to the source. Similarly, debugging optimized binaries can also cause unexpected jumps in the execution trace.

Debugging Software Using SDK

In this example, you will walk through debugging a hello world application.

If you did not create a hello world application on APU or RPU, follow the steps in [Create Bare-Metal Application for Arm Cortex-A53 based APU, page 42](#) to create a new hello world application.

After you create the Hello World Application, work through below example to debug the software using SDK.

1. Follow the steps in [Example Project: Running the “Hello World” Application from Arm Cortex-A53](#) to set the target in JTAG mode and power ON.
2. In the C/C++ Perspective, right-click the `test_a53` Project and select **Debug As > Launch on Hardware (System Debugger)**.

Note: The above step launches the System Debugger in the Debug perspective based on the project settings. Alternatively, you can also create a Debug configuration which looks like [Figure 4-2](#).

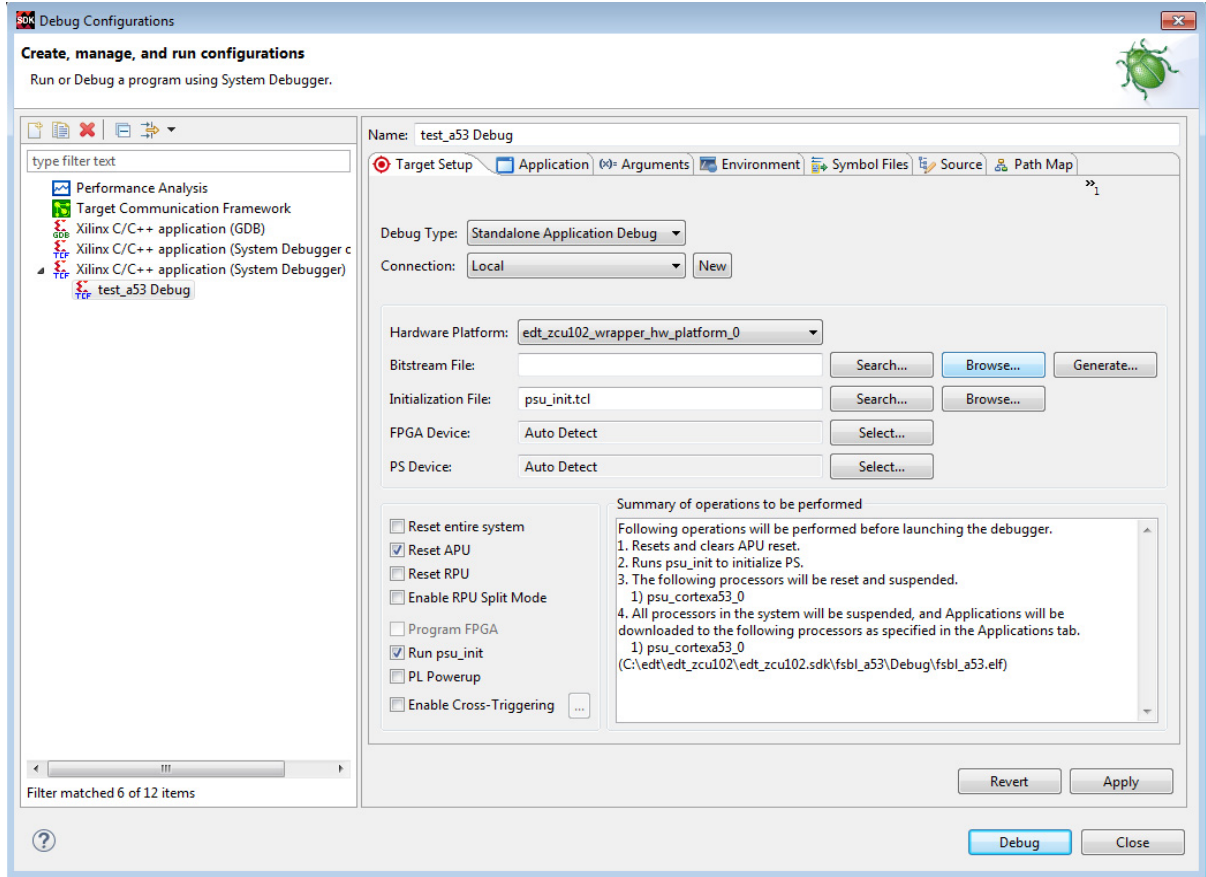

Figure 4-2: Debug Configurations

If the **Confirm Perspective Switch** popup window appears, click **Yes**. The Debug Perspective opens.

Note: If the Debug Perspective window does not automatically open, select **Window > Perspective > Open Perspective > Other**, then select **Debug** in the Open Perspective wizard.

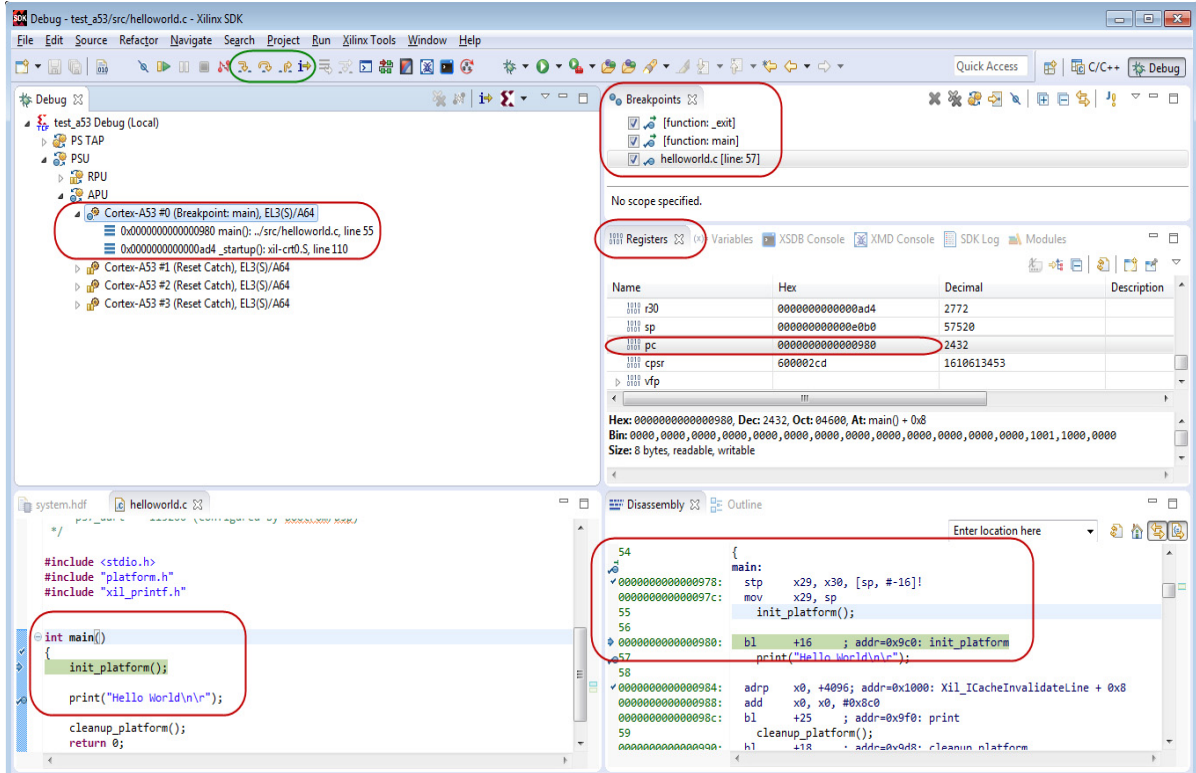

Figure 4-3: Application Debug Perspective

Note: The addresses shown on this page might slightly differ from the addresses shown on your system.

The processor is currently sitting at the beginning of `main()` with program execution suspended at line `0x0000000000000980`. You can confirm this information in the Disassembly view, which shows the assembly-level program execution also suspended at `0x0000000000000980`.

Note: If the Disassembly view is not visible, select **Window > Show View > Disassembly**.

3. The `helloworld.c` window also shows execution suspended at the first executable line of C code. Select the Registers view to confirm that the program counter, pc register, contains `0x0000000000000980`.

Note: If the Registers window is not visible, select **Window > Show View > Registers**.

4. Double-click in the margin of the `helloworld.c` window next to the line of code that reads `printf("Hello World\n\r");`. This sets a breakpoint at the `printf` command. To confirm the breakpoint, review the Breakpoints window.

Note: If the Breakpoints window is not visible, select **Window > Show View > Breakpoints**.

5. Select **Run > Step Into** to step into the `init_platform()` routine.

Program execution suspends at location `0x00000000000009c8`. The call stack is now two levels deep.

6. Select **Run > Resume** to continue running the program to the breakpoint.

Program execution stops at the line of code that includes the `printf` command. The Disassembly and Debug windows both show program execution stopped at `0x00000000000000984`.

Note: The execution address in your debugging window might differ if you modified the hello world source code in any way.

7. Select **Run > Resume** to run the program to conclusion.

When the program completes, the Debug window shows that the program is suspended in a routine called `exit`. This happens when you are running under control of the debugger.

8. Re-run your code several times. Experiment with single-stepping, examining memory, breakpoints, modifying code, and adding print statements. Try adding and moving views.



TIP: You can use SDK tool debugging shortcuts for step-into (F5), step-return (F7), step-over (F6), and resume (F8).

Debugging Using XSCT

You can use the previous steps to debug bare-metal applications running on RPU and PMU using SDK system Debugger GUI.

Additionally, you can debug in the command line mode using XSDB, which is encapsulated as a part of XSCT. In this example, you will debug the bare-metal application `testapp_r5` using XSCT.

Following steps indicate how to load a bare-metal application on R5 using XSCT.

This example is just to demonstrate the command line debugging possibility using XSDB/XSCT. Based on the requirement, you can choose to debug the code using either the System Debugger graphical interface or the command line debugger in XSCT. All XSCT commands are scriptable and this applies to the commands covered in this example.

Set Up Target

1. Connect a USB cable between USB-JTAG J2 connector on target and the USB port on the host machine.
2. Set the board in JTAG Boot mode, where SW6 is set as shown in following figure.

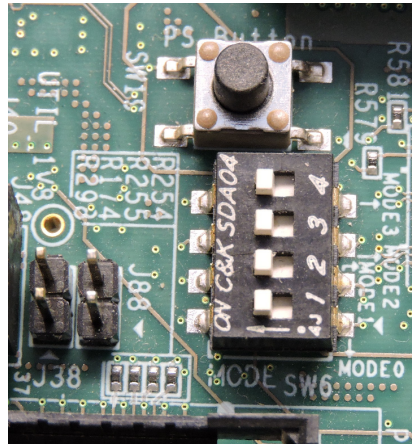



Figure 4-4: SW6 Switch Settings for JTAG Boot Mode

3. Power on the Board using switch SW1.
4. Open XSCT Console in SDK, click the **XSCT Console** button  in the SDK tool bar.
Alternatively, you can also open the XSCT console from **Xilinx > XSCT Console**.
5. In the XSCT Console, connect to the target over JTAG using the `connect` command:

```
xsct% connect
```

The `connect` command returns the channel ID of the connection.
6. Command **targets** lists the available targets and allows you to select a target through its ID.

The targets are assigned IDs as they are discovered on the JTAG chain, so the target IDs can change from session to session.

For non-interactive usage such as scripting, the `-filter` option can be used to select a target instead of selecting the target through its ID:

```
xsct% targets
```

The targets are listed as shown in the following figure.

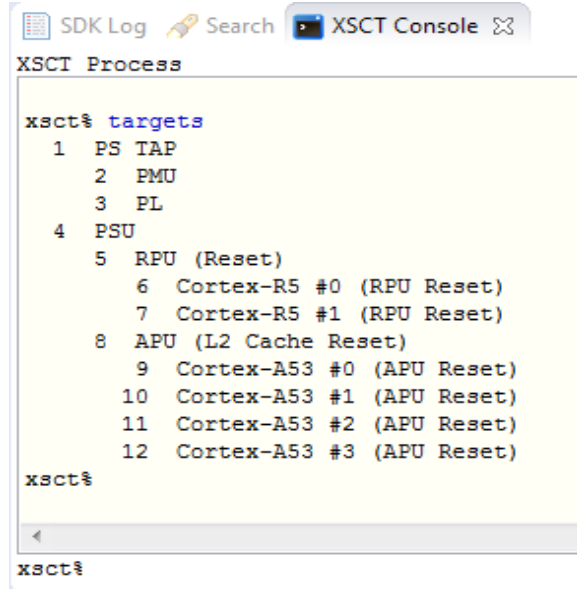

Figure 4-5: Target List

- Now select PSU target. The Arm APU and RPU clusters are grouped under PSU.

```
xscct% targets -set -filter {name=~ "PSU"}
```

The command `targets` now lists the targets and also shows the selected target highlighted with an asterisk (*) mark. You can also use target number to select a Target, as shown in the following figure.

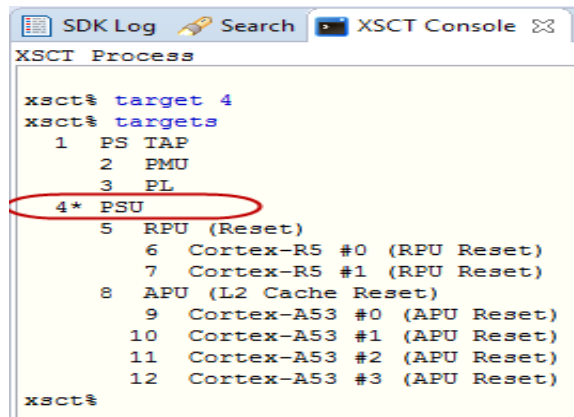

Figure 4-6: PSU Target Selected

- Source the `psu_init.tcl` script and run the `psu_init` command to initialize the Processing System of Zynq® UltraScale+™.

```

xscct% source
{C:\edt\edt_zcu102\edt_zcu102.sdk\edt_zcu102_wrapper_hw_platform_0\psu_init.tcl}
xscctk% psu_init
  
```

Note the { } used in above command. These are required on windows machine to enable backward slash (\) in paths. These braces can be avoided by using forward "/" in paths. Considering Linux paths, use forward "/" because the paths in XSCT in Linux can work as is, without any braces.

Load the Application Using XSCT

1. Now download the testapp_r5 application on Arm R5 Core 0.
2. Check and select RPU Cortex-R5 Core 0 target ID

```
xsct% targets
xsct% targets -set -filter {name =~ "Cortex-R5 #0"}
xsct% rst -processor
```

The command `rst -processor` clears the reset on an individual processor core.

This step is important, because when Zynq MPSoC boots up JTAG boot mode, all the A53 and R5 cores are held in reset. You must clear the resets on each core, before debugging on these cores. The `rst` command in XSDB can be used to clear the resets.

Note: The command `rst -cores` clears resets on all the processor cores in the group (such as APU or RPU), of which the current target is a child. For example, when A53 #0 is the current target, `rst -cores` clears resets on all the A53 cores in APU.

```
xsct% dow {C:\edt\edt_zcu102\edt_zcu102.sdk\testapp_r5\Debug\testapp_r5.elf}
```

Or

```
xsct% dow C:/edt/edt_zcu102/edt_zcu102.sdk/testapp_r5/Debug/testapp_r5.elf
```

At this point, you can see the sections from the ELF file downloaded sequentially. The XSCT prompt can be seen after successful download.

Now, configure a serial terminal (Tera Term, Mini com, or the SDK Serial Terminal interface for UART-1 USB-serial connection).

Serial Terminal Configuration

1. Start a terminal session, using Tera Term or Mini com depending on the host machine being used, and the COM port and baud rate as shown in following figure.

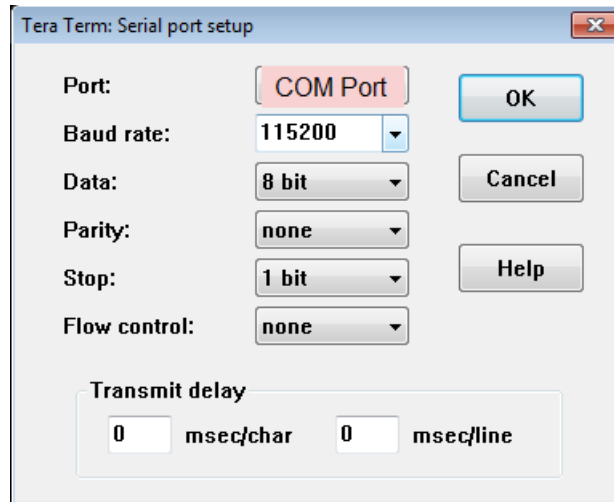

Figure 4-7: COM Port Set Up

2. For port settings, verify the COM port in the device manager. There are four USB UART interfaces exposed by the ZCU102 board. Select the COM port associated with the interface with the lowest number. So in this case, for UART-0, select the COM port with interface-0.
3. Similarly, for UART-1, select COM port with interface-1. Remember that R5 BSP has been configured to use UART-1, and so R5 application messages will appear on the COM port with UART-1 terminal.

Run and Debug Application Using XSCT

1. Now before you run the application, set a breakpoint at `main()`.

```
xsct% bpadd -addr &main
```

This command returns the breakpoint ID.

You can verify the breakpoints planted using command `bp list`.

For more details on breakpoints in XSCT, type `help breakpoint` in XSCT,

2. Now resume the processor core.

```
xsct% con
```

The following informative messages will be displayed when the core hits the breakpoint.

```
xsct% Info: Cortex-R5 #0 (target 7) Stopped at 0x10021C (Breakpoint)
```

3. At this point, you can view registers when the core is stopped.

```
xsct% rrd
```

4. View local variables

```
xsct% locals
```

5. Step over a line of the source code and view the stack trace.

```
xsct% nxt
```

```
Info: Cortex-R5 #0 (target 6) Stopped at 0x100490 (Step)
```

```
xsct% bt
```

You can use the `help` command to find other options:

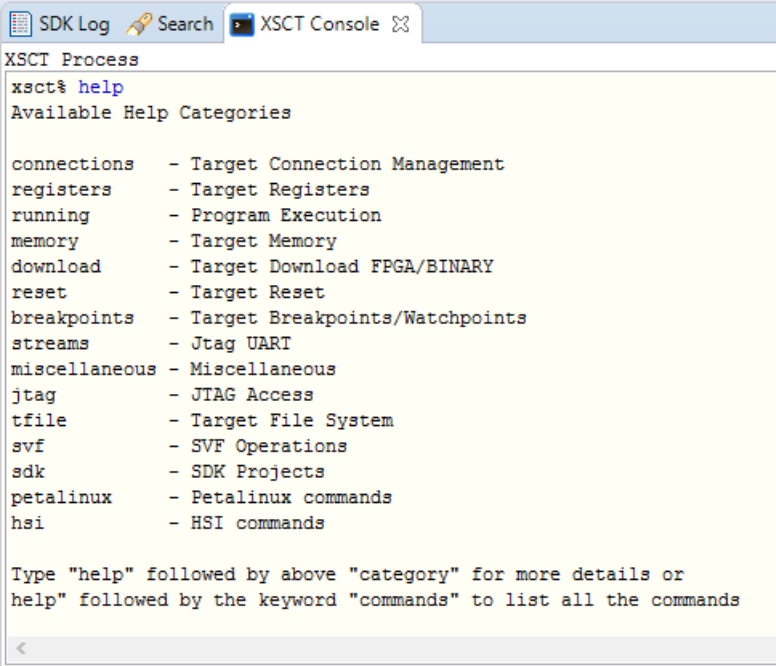

```
SDK Log Search XSC Console X
XSC Process
xsct% help
Available Help Categories

connections - Target Connection Management
registers   - Target Registers
running     - Program Execution
memory      - Target Memory
download    - Target Download FPGA/BINARY
reset       - Target Reset
breakpoints - Target Breakpoints/Watchpoints
streams     - Jtag UART
miscellaneous - Miscellaneous
jtag        - JTAG Access
tfile       - Target File System
svf         - SVF Operations
sdk         - SDK Projects
petalinux   - Petalinux commands
hsi         - HSI commands

Type "help" followed by above "category" for more details or
help" followed by the keyword "commands" to list all the commands
<
xsct%
```

Figure 4-8: XSC Help Categories

You can use the `help running` command to get a list of possible options for running or debugging an application using XSCT.

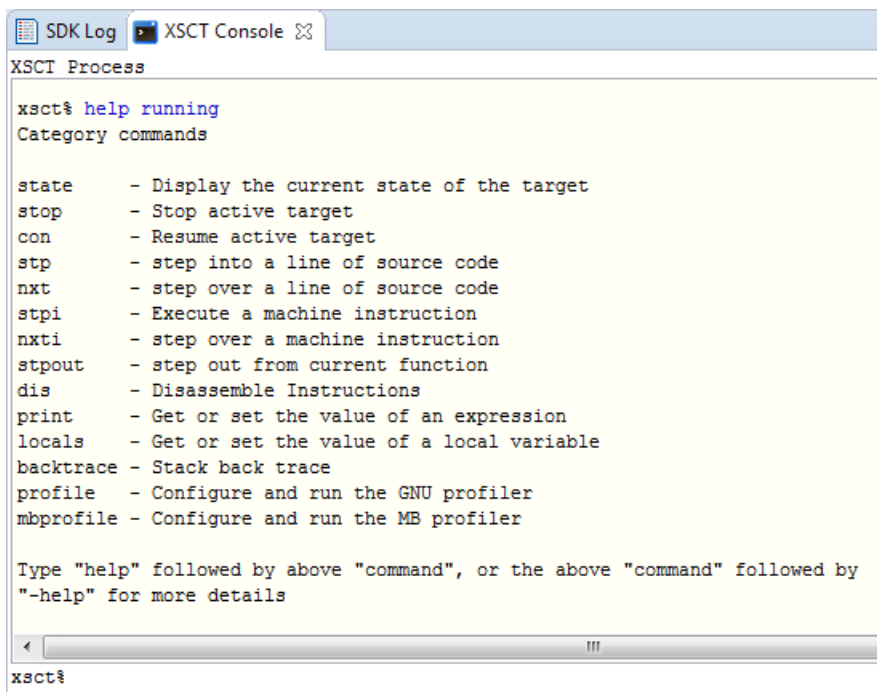

```

XSCT Process
xsct% help running
Category commands

state      - Display the current state of the target
stop       - Stop active target
con        - Resume active target
stp        - step into a line of source code
nxt        - step over a line of source code
stpi       - Execute a machine instruction
nxti       - step over a machine instruction
stpout     - step out from current function
dis        - Disassemble Instructions
print      - Get or set the value of an expression
locals     - Get or set the value of a local variable
backtrace  - Stack back trace
profile    - Configure and run the GNU profiler
mbprofile  - Configure and run the MB profiler

Type "help" followed by above "command", or the above "command" followed by
"-help" for more details

xsct%

```

Figure 4-9: XSCT Help for Debugging Program Execution

6. You can now run the code:

```
xsct% con
```

At this point, you can see the R5 application print message on UART-1 terminal.

Debugging FSBL using SDK

The FSBL is built with Size Optimization and Link Time Optimization Flags, that is `-Os` and `LTO` optimizations by default in SDK. This reduces the memory footprint of FSBL. This needs to be disabled for debugging FSBL.

Removing optimization can lead to increased code size, resulting in failure to build the FSBL. To disable the optimization (for debugging), some FSBL features (that are not required), need to be disabled in `xfsbl_config.h` file of FSBL.

Now, create a new FSBL for this section instead of modifying the FSBL created in [Chapter 3, Build Software for PS Subsystems](#). This is to avoid disturbing the `FSBL_a53` project, which will be used extensively in rest of the chapters in this tutorial.

Create and Modify FSBL

Use the following steps to create an FSBL project.

1. Start SDK if it is not already open.
2. Set the Workspace path based on the project you created in [Chapter 3, Build Software for PS Subsystems](#). For example, C:\edt\edt_zcu102\edt_zcu102.sdk.
3. Select **File > New > Application Project**.

The New Project dialog box opens.

4. Use the information in the following table to make your selections in the New Project dialog box.

Table 4-1: Settings to Create FSBL_debug Project

Wizard Screen	System Properties	Setting or Command to Use
Application Project	Project Name	fsbl_debug
	Use Default Location	Select this option
	OS Platform	Standalone
	Hardware Platform	edt_zcu102_wrapper_hw_platform_0
	Processor	psu_cortexa53_0
	Language	C
	Compiler	64-bit
	Hypervisor Guest	No
	Board Support Package	Select Create New and provide the name of fsbl_debug_bsp
Click Next		
Templates	Available Templates	Zynq MP FSBL

5. Click **Finish**.

SDK creates the board Support package and an FSBL application. Now disable Optimizations as shown below.

1. In the Project Explorer folder, right-click the **fsbl_debug** application.
2. Click **C/C++ Build Settings**.
3. Select **Settings > Tool Settings** tab > **Arm A53 gcc Compiler > Miscellaneous**
4. Remove **-Os -flto -ffat-lto-objects** from other flags, as shown below.

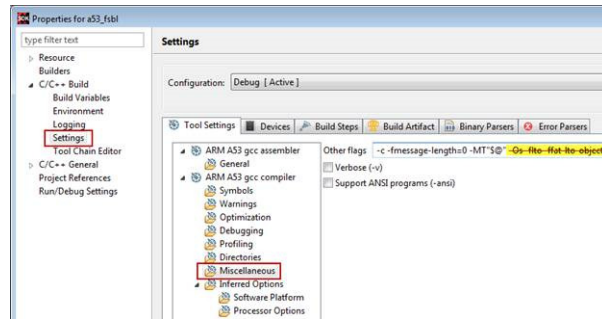

Figure 4-10: Modify FSBL BSP Build Settings

Similarly, the fsbl_debug_bsp needs to be modified to disable optimization.

5. Right-click **fsbl_debug_bsp** and select **Board Support Package Settings**.
6. Under **Overview > Drivers > psu_cortexa53_0 > extra_compiler_flags**, edit **extra_compiler_flags** to remove "-Os -flto -ffat-lto-objects" as shown below.



Figure 4-11: Modify FSBL BSP Build Settings

7. Under **Overview**, click **Standalone**
8. Change **zynqmp_fsbl_bsp** flag to false to avoid resetting of default optimization settings of BSP for FSBL when BSP rebuilds after these changes.

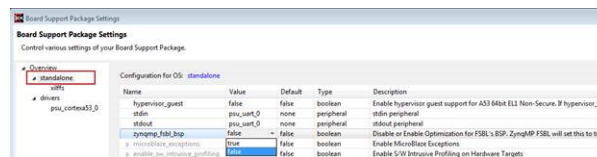

Figure 4-12: Modify FSBL BSP Build Settings

9. Click **OK**, to save these settings. BSP re-builds automatically after this.

At this point FSBL is ready to be debugged.

You can either debug the FSBL like any other standalone application (as shown in [Debugging Software Using SDK](#) and [Debugging Using XSCT](#)), or debug FSBL as a part of a Boot image by using the 'Attach to running target' mode of System Debugger.

Boot and Configuration

This chapter shows integration of components to create a Zynq UltraScale+ system. The purpose of this chapter is to understand how to integrate and load Boot loaders, bare-metal applications (For APU/RPU), and Linux Operating System for a Zynq UltraScale+ system.

The following important points are covered in this chapter:

- System Software: FSBL, U-Boot, Arm® trusted firmware (ATF)
- Application Processing Unit (APU): Configure SMP Linux for APU
- Real-time Processing Unit (RPU): Configure Bare-metal for RPU in Lock-step
- Create Boot Image for the following Boot sequence:
 - a. APU
 - b. RPU Lock-step
- Create and load Secure Boot Image

Note: For more information on RPU Lock-step, see *Zynq UltraScale+ MPSoC Technical Reference Manual* (UG1085) [Ref 5].

This boot sequence also includes loading the PMU Firmware for the Platform Management Unit (PMU). You can achieve the above configurations using a Xilinx SDK and PetaLinux Tool flow. While [Chapter 3](#) focused only on creating software blocks for each processing unit in the PS, this chapter explains how these blocks can be loaded as a part of a bigger system.

The Create Boot Image wizard (Bootgen - Command Line tool) from SDK is used in generating Boot Image. Create Boot Image Wizard's or Bootgen's principle function is to integrate the partitions (hardware-bitstream and software), and allow you to specify the security options in the design. It can also create the cryptographic keys.

Functionally, Bootgen uses a Bootgen Image Format (BIF) file as an input, and generates a single file image in binary BIN or MCS format. Bootgen outputs a single file image which is loaded into NVM (QSPI, SD Card). The Bootgen GUI facilitates the creation of the BIF input file.

This chapter makes use of Processing System block. [Design Example 1: Using GPIOs, Timers, and Interrupts](#), covers Boot-image which will include the PS partitions used in this chapter and a bitstream targeted for PL fabric.

System Software

The following system software blocks cover most of the Boot and Configuration for this chapter. For detailed boot flow and various Boot sequences, refer to the “System Boot and Configuration” chapter in the *Zynq UltraScale+ MPSoC: Software Developers Guide* (UG1137) [Ref 6].

First Stage Boot Loader

In non-secure Boot mode, the platform management unit (PMU) releases the reset of the configuration security unit, and enters the PMU server mode to monitor power. At this stage the configuration security unit loads the first stage boot loader (FSBL) into on-chip memory (OCM). The FSBL can be run from either APU A53_0 or RPU R5_0 or RPU R5_lockstep. In this example, the FSBL is targeted for APU A53 Core 0. The last 512 bytes of this region is used by FSBL to share the handoff parameters corresponding to applications which ATF hands off.

The First Stage Boot Loader initializes important blocks in the processing subsystem. This includes clearing the reset of the processors, initializing clocks, memory, UART, and so on before handing over the control of the next partition in DDR, to either RPU or APU. In this example, the FSBL loads bare-metal application in DDR and handsoff to RPU R5 in Lockstep mode, and similarly loads U-Boot to be executed by APU A53 Core-0. For more information, see the *Zynq UltraScale+ MPSoC: Software Developers Guide* (UG1137) [Ref 6].

For this chapter, you can use the FSBL executable that you created in [Chapter 3](#). In FSBL application, the `xfsbld_translation_table.S` differs from `translation_table.S` (of A53) in only one aspect, to mark DDR region as reserved. This is to avoid speculative access to DDR before it is initialized. Once the DDR initialization is done in FSBL, memory attributes for DDR region is changed to “Memory” so that it is cacheable.

Platform Management Unit Firmware

The platform management unit (PMU) and the configuration security unit manage and perform the multi-staged booting process. The PMU primarily controls the pre-configuration stage that executes PMU ROM to set up the system. The PMU handles all of the processes related to reset and wake-up. SDK provides PMU Firmware that can be built to run on the PMU. For more details on the Platform Management and PMU Firmware, see the *Zynq UltraScale+ MPSoC: Software Developers Guide* (UG1137) [Ref 6].

The PMU Firmware can be loaded in the following ways:

1. Using BootROM to load PMU Firmware, as described in [Boot Sequence for SD-Boot](#)
2. Using FSBL to load PMU Firmware, as described in [Boot Sequence for QSPI Boot Mode](#)

3. Load PMU Firmware in JTAG boot mode, as described in [Boot Sequence for QSPI-Boot Mode Using JTAG](#).

For more information, see the [PMU Firmware Xilinx Wiki](#).

U-Boot

The U-Boot acts as a secondary boot loader. After the FSBL handoff, the U-Boot loads Linux on Arm A53 APU. After FSBL, the U-Boot configures the rest of the peripherals in the processing system based on board configuration. U-Boot can fetch images from different memory sources like eMMC, SATA, TFTP, SD, and QSPI. For this example, U-Boot and all other images are loaded from the SD card. Therefore, for this example, the Board will be set to SD-boot mode.

U-Boot can be configured and built using the PetaLinux tool flow. For this example, you can use the U-Boot image that you created in [Chapter 3](#) or from the design files shared with this document. See [Design Files for This Tutorial, page 163](#) for information about downloading the design files for this tutorial.

Arm Trusted Firmware

The Arm Trusted Firmware (ATF) is a transparent bare-metal application layer executed in Exception Level 3 (EL3) on APU. The ATF includes a Secure Monitor layer for switching between secure and non-secure world. The Secure Monitor calls and implementation of Trusted Board Boot Requirements (TBBR) makes the ATF layer a mandatory requirement to load Linux on APU on Zynq UltraScale+.

The FSBL loads ATF to be executed by APU, which keeps running in EL3 awaiting a service request. The ATF starts at 0xFFFEA000. The FSBL also loads U-Boot in DDR to be executed by APU, which loads Linux OS in SMP mode on APU. It is important to note that the PL Bitstream should be loaded before ATF is loaded. The reason is FSBL uses the OCM region which is reserved for ATF for holding a temporary buffer in the case where bitstream is present in `.BIN` file. Because of this, if bitstream is loaded after ATF, FSBL will overwrite the ATF image with its temporary buffer, corrupting ATF image. Hence, bitstream should be positioned in `.BIF` before ATF and preferably immediately after FSBL and PMUFW.

The ATF (`b131.e1f`) is built by default in PetaLinux and can be found in the PetaLinux Project images directory.

For more details on ATF, refer to the "Arm Trusted Firmware" section in the "Security" chapter of the *Zynq UltraScale+ MPSoC: Software Developers Guide* (UG1137) [\[Ref 6\]](#).

Linux on APU and Bare-Metal on RPU

Now that the system software is configured, create Linux Images using PetaLinux Toolflow. You already created the PetaLinux images in [Chapter 3](#). For this example, the PetaLinux is configured to build images for SD-boot. This is the default boot setting in PetaLinux.

The images can be found in the `$(PetaLinux_Project)/images/linux/` directory.

For loading Linux on APU, the following images will be used from PetaLinux:

- ATF - `bl31.elf`
- U-Boot - `u-boot.elf`
- Linux images - `image.ub`, which contains:
 - Kernel image
 - Device Tree `System.dtb`
 - Filesystem - `rootfs.cpio.gz.u-boot`

In addition to Linux on APU, this example also loads a bare-metal Application on RPU R5 in Lockstep mode.

For this example, refer the `testapp_r5` application that you created in [Create Bare-Metal Application for Arm Cortex-R5 based RPU, page 43](#).

Alternatively you can also find the `testapp_r5.elf` executable in the design files that accompany this tutorial. See [Design Files for This Tutorial, page 163](#) for information about downloading the design files for this tutorial.

Boot Sequence for SD-Boot

Now that all the individual images are ready, let's create the boot image to load all of these components on Zynq UltraScale+. This can be done using the Create Boot Image wizard in SDK, using the following steps:

1. In SDK, select **Xilinx > Create Boot Image**.
2. Select all the partitions referred in earlier sections in this chapter, and set them as shown in the following figure.

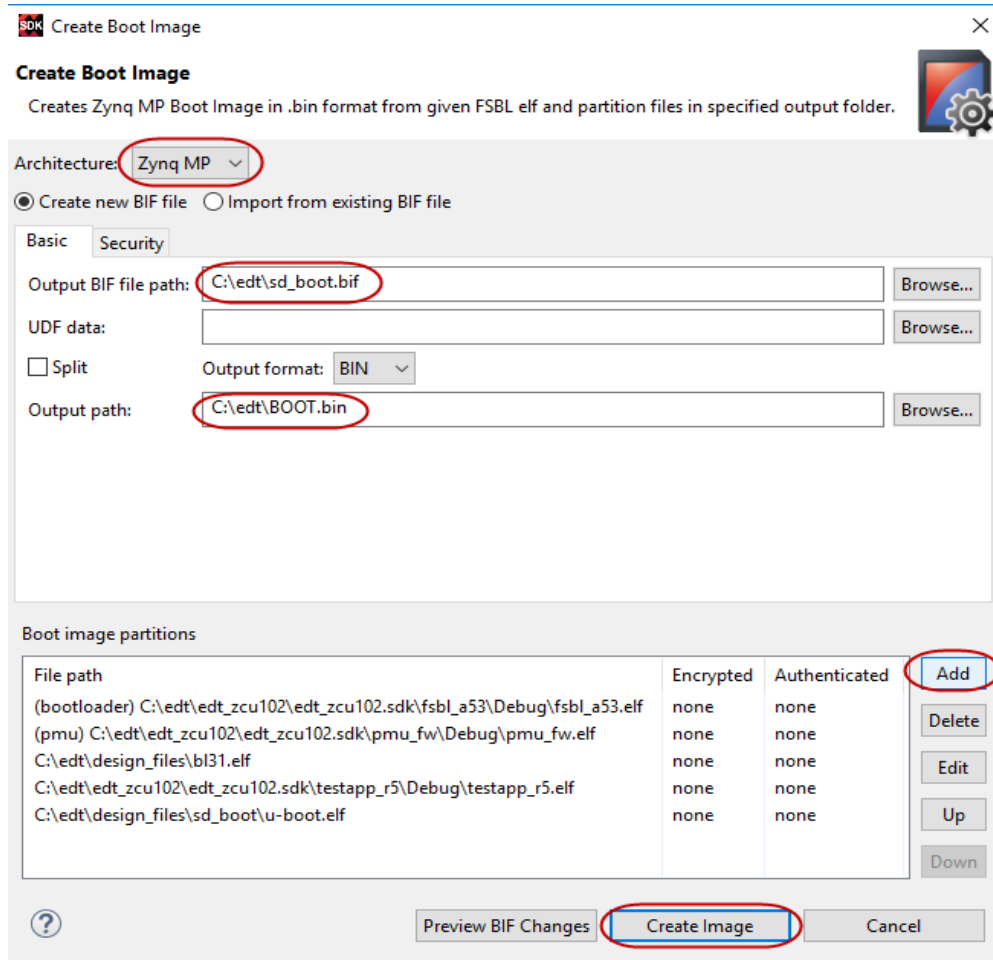

Figure 5-1: Create Boot Image for SD Boot Mode

First, add the FSBL partition.

1. In the Create Boot Image dialog box, click **Add** to open the Add partition dialog box.
2. In the Add Partition dialog box, click **Browse** to select the FSBL executable.
3. For FSBL, ensure that the partition type is selected as `bootloader` and the correct destination CPU is selected by the tool. The tool is configured to make this selection based on the FSBL executable.

Note: Ignore the Exception Level drop down, as FSBL is set to EL3 by default. Also, leave the Trustzone setting unselected for this example.

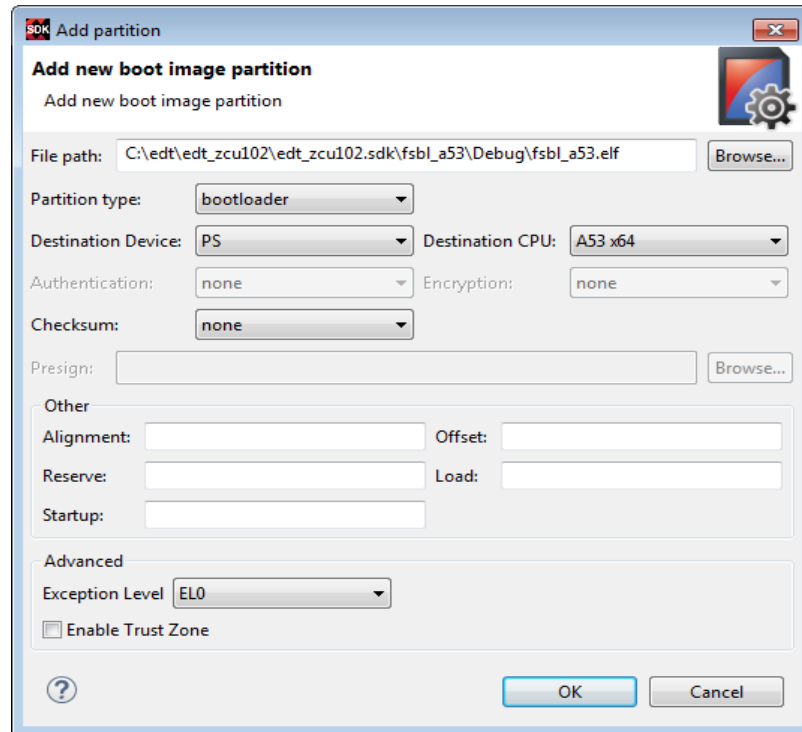

Figure 5-2: Add New Boot Image Partition Dialog Box

4. Click **OK** to select FSBL and go back to Create Boot Image wizard.

Next, add the PMU and ATF firmware partitions.

1. Click **Add** to open the Add Partition dialog box, shown in the following figure.

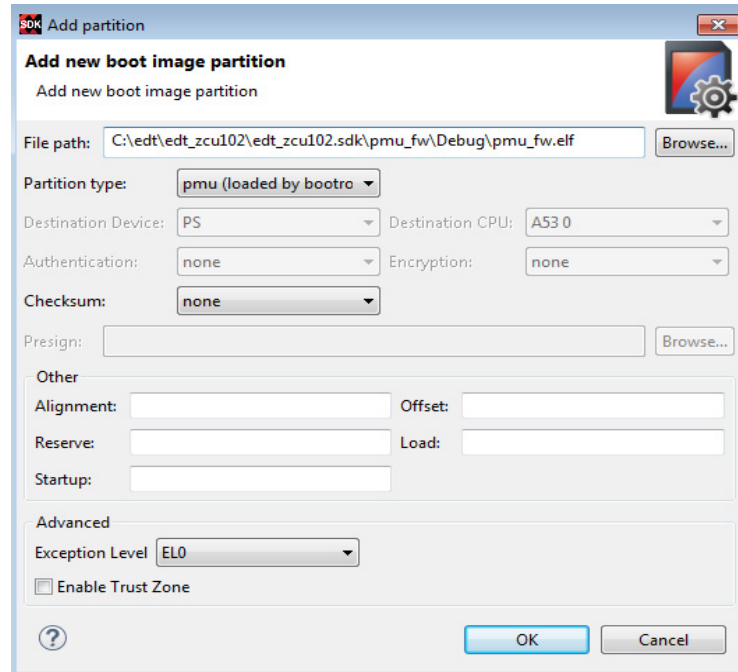

Figure 5-3: Add PMUFW Partition

2. Add the PMU firmware partition.
 - a. Browse to and select the PMU Firmware executable.
 - b. For this partition, select **pmu** as the partition type.

Note: The **pmu** partition type also implies that the executable is targeted for PMU. Therefore, the **Destination Device** and **Destination CPU** are grayed out for this setting.
3. Leave the Exception Level and Trustzone settings unselected.
4. Click **OK**.
5. Click **Add** to open Add Partition dialog box.
6. Add the **ATF firmware** `b131.elf` partition.

Note: ATF Firmware (`b131.elf`) can be found in `<PetaLinux Project>/image/linux/`. Alternatively, you can also use `b131.elf` from [Design Files for This Tutorial](#).

 - a. For this partition, select **datafile** as the partition type.
 - b. Set the Destination Device as **PS**.
 - c. Set the Destination CPU as **A53 0**.
 - d. Set the Exception Level to **EL3** and select Enable **Trustzone**.

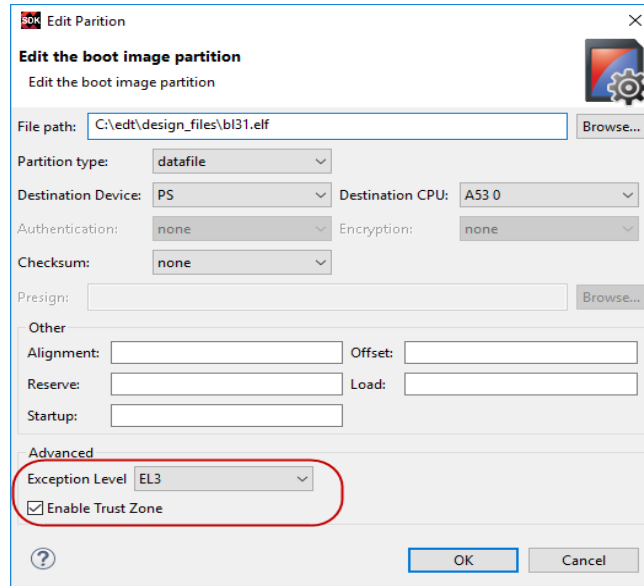

Figure 5-4: Add ATF partition

7. Click **OK**.

Next, add the R5 executable and enable it in lockstep mode.

1. Click **Add** to add the R5 bare-metal executable.

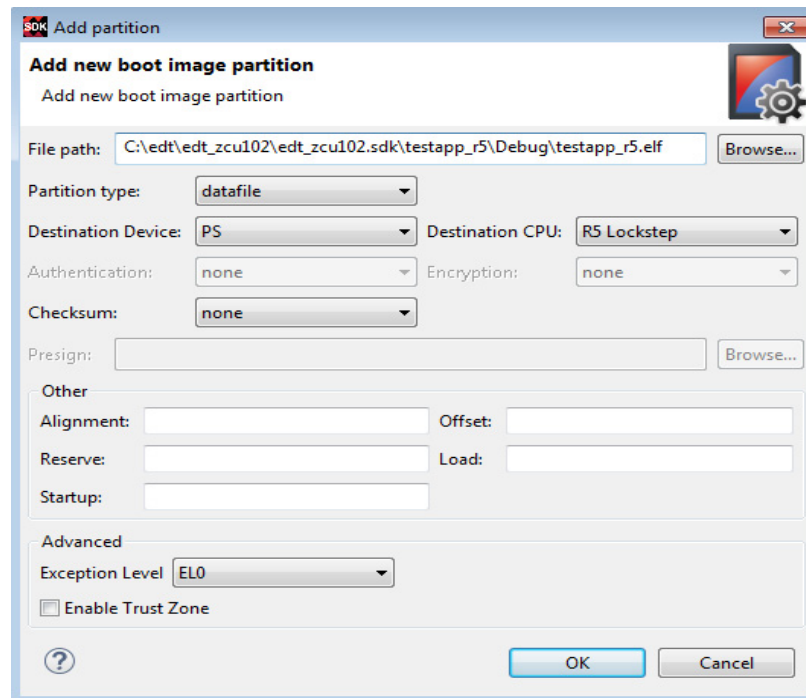

Figure 5-5: Add RPU Image Partition

2. Set the Destination Device as **PS**.

3. Set the Destination CPU as **R5 Lockstep**.

This sets the RPU R5 cores to run in Lockstep mode.

4. Leave Exception Level and Trustzone unselected.
5. Click **OK**.

Now, add the U-Boot partition. You can find `u-boot.elf` for `sd_boot` mode in `<PetaLinux_project>/images/linux/sd_boot`

1. Click **Add** to add the `u-boot.elf` partition.
2. For U-Boot, select the Destination Device as PS.
3. Select the Destination CPU as **A53 0**.
4. Set the Exception Level to **EL2**.

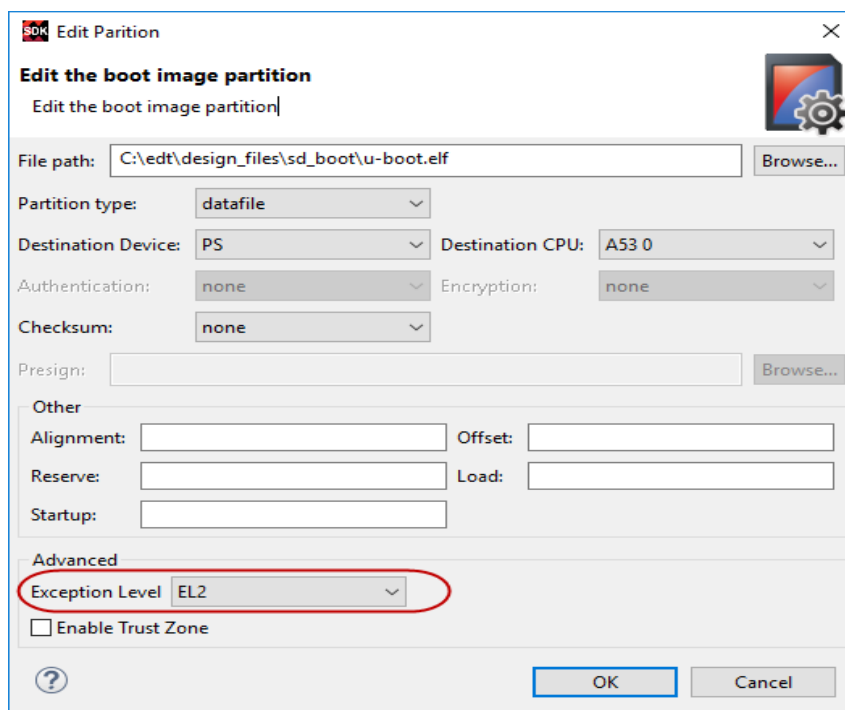

Figure 5-6: Add U-Boot Partition

5. Click **OK** to return to the Create Boot Image wizard.
6. Click **Create Image** to close the wizard and create the boot image.

You can also create `BOOT.bin` images using the BIF attributes and the `Bootgen` command.

For this configuration, the BIF file contains following attributes:

```

the_ROM_image:
{
  [bootloader, destination_cpu=a53-0]
  [bootloader]C:\edt\edt_zcu102\edt_zcu102.sdk\fsbl_a53\Debug\fsbl_a53.elf
  [pmufw_image]C:\edt\edt_zcu102\edt_zcu102.sdk\pmu_fw\Debug\pmu_fw.elf
  [destination_cpu = a53-0, exception_level=e1-3,
  trustzone]C:\edt\design_files\bl31.elf
  [destination_cpu =
  r5-lockstep]C:\edt\edt_zcu102\edt_zcu102.sdk\testapp_r5\Debug\testapp_r5.elf
  [destination_cpu = a53-0,
  exception_level=e1-2]C:\edt\design_files\sd_boot\u-boot.elf
}

```

SDK calls the following Bootgen command to generate the BOOT.bin image for this configuration:

```
bootgen -image sd_boot.bif -arch zynqmp -o C:\edt\BOOT.bin
```

Running the Image on the ZCU102 Board

1. Copy the BOOT.BIN and image.ub images to an SD card.
2. Load the SD card into the ZCU102 board, in the J100 connector.
3. Connect a micro USB cable from ZCU102 Board USB UART port (J83), to the USB port on the host Machine.
4. Configure the Board to Boot in SD-Boot mode by setting switch SW6 to 1-ON, 2-OFF, 3-OFF and 4-OFF, as shown in following figure.



Figure 5-7: SW6 Switch Settings for SD Boot Mode

5. Connect 12V Power to the ZCU102 6-Pin Molex connector.

6. Start a terminal session, using Tera Term or Minicom depending on the host machine being used, as well as the COM port and baud rate for your system, as shown in following figure.

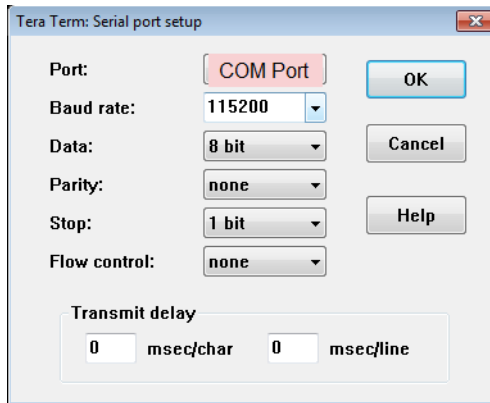

Figure 5-8: COM Port Set Up

7. For port settings, verify COM port in device manager.

There are four USB-UART interfaces exposed by the ZCU102 Board.

8. Select the COM port associated with the interface with the lowest number. In this case, for UART-0, select the COM port with interface-0.
9. Similarly, for UART-1, select COM port with interface-1.

Remember that the R5 BSP has been configured to use UART-1, and so R5 application messages will appear on the COM port with the UART-1 terminal.

10. Turn on the ZCU102 Board using SW1, and wait until Linux loads on the board.

At this point, you can see the initial Boot sequence messages on your Terminal Screen representing UART-0.

You can see that the terminal screen configured for UART-1 also prints a message. This is the print message from the R5 bare-metal Application running on RPU, configured to use UART-1 interface. This application is loaded by the FSBL onto RPU.

The bare-metal application has been modified to include the UART interrupt example. This application now waits in the waiting for interrupt (WFI) state until a user input is encountered from Keyboard in UART-1 terminal.

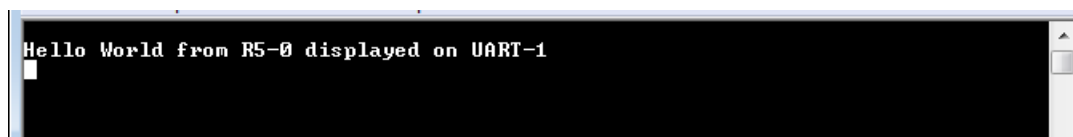

Figure 5-9: Hello World Displayed on UART-1 from R5-0

Meanwhile, the boot sequence continues on APU and the images loaded can be understood from the messages appearing on the UART-0 terminal. The messages are highlighted in the following figure.

```

Xilinx Zynq MP First Stage Boot Loader
Release 2018.2 Jul 24 2018 - 11:16:05
Reset Mode : System Reset
Platform: Silicon (4.0), Cluster ID 0x80000000
Running on A53-0 (64-bit) Processor, Device Name: XCZU9EG
FMC VADJ Configuration Successful
Board Configuration successful
Processor Initialization Done
===== In Stage 2 =====
SD1 with level shifter Boot Mode
SD: rc= 0
File name is BOOT.BIN FSBL on ARM Cortex-A53
Multiboot Reg : 0x0
Image Header Table Offset 0x8C0
****Image Header Table Details****
Boot Gen Ver: 0x1020000
No of Partitions: 0x5
Partition Header Address: 0x440
Partition Present Device: 0x0
Initialization Success
===== In Stage 3, Partition No:1 =====
UnEncrypted data Length: 0x31F4
Data word offset: 0x31F4
Total Data word length: 0x31F4
Destination Load Address: 0xFFFEA000
Execution Address: 0xFFFEA000
Data word offset: 0x10180
Partition Attributes: 0x117
Partition 1 Load Success
===== In Stage 3, Partition No:2 =====
UnEncrypted data Length: 0x142
Data word offset: 0x142
Total Data word length: 0x142
Destination Load Address: 0x0
Execution Address: 0x3C
Data word offset: 0x13380
Partition Attributes: 0x71E
Initializing TCM ECC
Address 0xFFE00000, Length 40000, ECC initialized
Partition 2 Load Success
===== In Stage 3, Partition No:3 =====
UnEncrypted data Length: 0x1C93
Data word offset: 0x1C93
Total Data word length: 0x1C93
Destination Load Address: 0x7F000000
Execution Address: 0x0
Data word offset: 0x134D0
Partition Attributes: 0x71E
Partition 3 Load Success
===== In Stage 3, Partition No:4 =====
UnEncrypted data Length: 0x33294
Data word offset: 0x33294
Total Data word length: 0x33294
Destination Load Address: 0x10080000
Execution Address: 0x10080000
Data word offset: 0x15170
Partition Attributes: 0x114
Partition 4 Load Success
All Partitions Loaded
===== In Stage 4 =====
Protection configuration applied
CPU 0x700 reset release, Exec State 0x8, HandoffAddress: 3C
ATF running on XCZU9EG/silicon v4/RTL5.1 at 0xffffea000
NOTICE: BL31: Secure code at 0x0 ARM Trusted Firmware
NOTICE: BL31: Non secure code at 0x10080000
NOTICE: BL31: v1.4 (release):xilinx-v2018.1-4-g93a69a5a
NOTICE: BL31: Built : 01:23:45, Jul 24 2018
PMUFW: v1.0
PMU Firmware loaded

U-Boot 2018.01 (Jul 24 2018 - 06:54:37 +0530) Xilinx ZynqMP ZCU102 rev1.0
I2C: ready
DRAM: 1.7 GiB U-boot on ARM Cortex-A53
EL Level: EL2
Chip ID: zu9eg
MMC: sdhci@ff170000: 0 (SD)
SF: Detected n25q512a with page size 512 Bytes, erase size 128 KiB, total 128 MiB
*** Warning - bad CRC, using default environment

```

Figure 5-10: Messages from APU During Zynq UltraScale+ Boot Sequence

The U-Boot then loads Linux Kernel and other images on Arm Cortex®-A53 APU in SMP mode. The terminal messages indicate when U-Boot loads Kernel image and the kernel start up to getting a user interface prompt in Target Linux OS. The Kernel loading and starting sequence can be seen in the following figure.

```
reading image.ub
75735640 bytes read in 4924 ms (14.7 MiB/s)
## Loading kernel from FIT Image at 10000000 ...
Using 'conf@1' configuration
Trying 'kernel@0' kernel subimage
  Description: Linux Kernel
  Type: Kernel Image
  Compression: uncompressed
  Data Start: 0x100000d8
  Data Size: 13171200 Bytes = 12.6 MiB
  Architecture: AArch64
  OS: Linux
  Load Address: 0x00080000
  Entry Point: 0x00080000
  Hash algo: sha1
  Hash value: f095d304a568f560fbc4e83dddaa1600b6ceb7d8
Verifying Hash Integrity ... sha1+ OK
## Loading ramdisk from FIT Image at 10000000 ...
Using 'conf@1' configuration
Trying 'ramdisk@0' ramdisk subimage
  Description: ramdisk
  Type: RAMDisk Image
  Compression: uncompressed
  Data Start: 0x10c9a378
  Data Size: 62520042 Bytes = 59.6 MiB
  Architecture: AArch64
  OS: Linux
  Load Address: unavailable
  Entry Point: unavailable
  Hash algo: sha1
  Hash value: 91828eafd9bd095cd965ecef79f863f8dd90fda
Verifying Hash Integrity ... sha1+ OK
## Loading fdt from FIT Image at 10000000 ...
Using 'conf@1' configuration
Trying 'fdt@0' fdt subimage
  Description: Flattened Device Tree blob
  Type: Flat Device Tree
  Compression: uncompressed
  Data Start: 0x10c8fbd0
  Data Size: 42737 Bytes = 41.7 KiB
  Architecture: AArch64
  Hash algo: sha1
  Hash value: fe11097c8fedecdee3e4bf31d27370e536896e85
Verifying Hash Integrity ... sha1+ OK
Booting using the fdt blob at 0x10c8fbd0
Loading Kernel Image ... OK
Loading Ramdisk to 04460000, end 07fffaea ... OK
Loading Device Tree to 0000000004452000, end 000000000445f6f0 ... OK

Starting kernel ...

[ 0.000000] Booting Linux on physical CPU 0x0
```

Figure 5-11: Kernel Loading and Start Sequence

Boot Sequence for QSPI Boot Mode

The ZCU102 board also comes with dual parallel QSPI Flashes adding up to 128 MB size. In this example, you will create a boot image and load the images on Zynq UltraScale+ in QSPI boot mode. The images can be configured using the Create Boot Image wizard in SDK. This can be done by doing the following steps.

Note: This section assumes that you have created PetaLinux Images for QSPI Boot mode by following steps from [Create Linux Images using PetaLinux for QSPI Flash](#).

1. If SDK is not already running, start it and set the workspace as indicated in [Chapter 3](#).
2. Select **Xilinx > Create Boot Image**.
3. Select **Zynq MP** as the Architecture.
4. Select the **Create new BIF file** option.
5. Ensure that the **Output format** is set to **BIN**.
6. In the Basic tab, browse to and select the **Output BIF file path** and **Output path**.

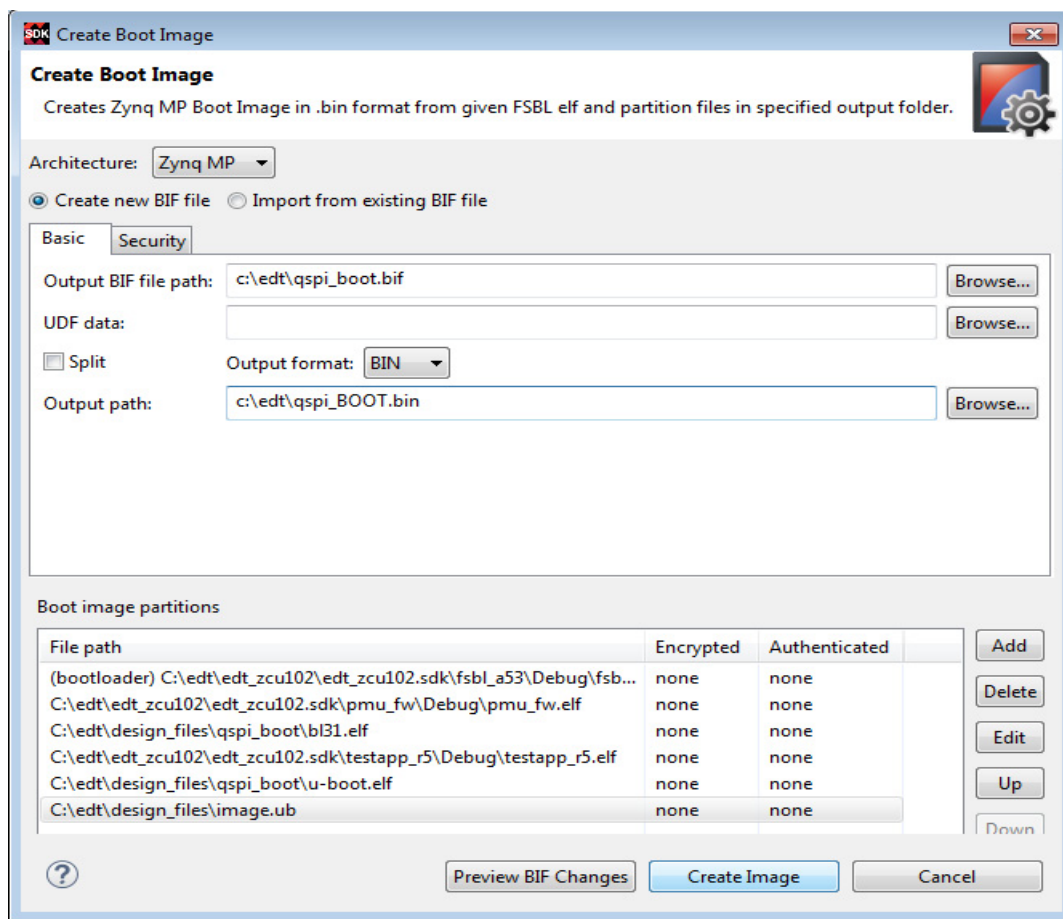

Figure 5-12: Create Boot Image for QSPI Boot Mode

Next, add boot partitions.

1. Click **Add** to open the Add Partition dialog box.
2. In the Add Partition dialog box, click the **Browse** button to select the FSBL executable.
 - a. For FSBL, ensure that the **Partition type** is selected as **bootloader** and the correct destination CPU is selected by the tool. The tool is configured to make this selection based on the FSBL executable.

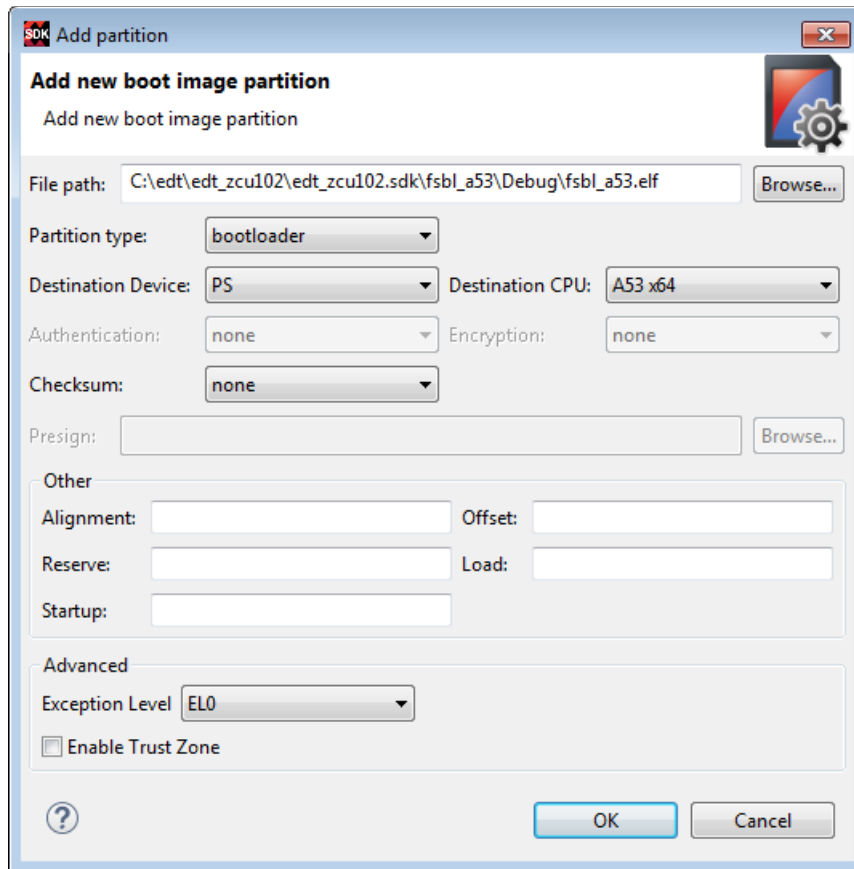

Figure 5-13: Add New Boot Image Partition Dialog Box

- b. Ignore the Exception Level, as FSBL is set to EL3 by default. Also, leave the Trustzone setting unselected for this example.
 - c. Click **OK** to select the FSBL and go back to the Create Boot Image wizard.
3. Click **Add** to open the Add Partition window to add the next partition.
4. The next partition is the PMU firmware for the Platform Management Unit.
 - a. Select the **Partition type** as **datafile** and the **Destination Device** as **PS**.
 - b. Select **PMU** for Destination CPU.
 - c. Click **OK**.

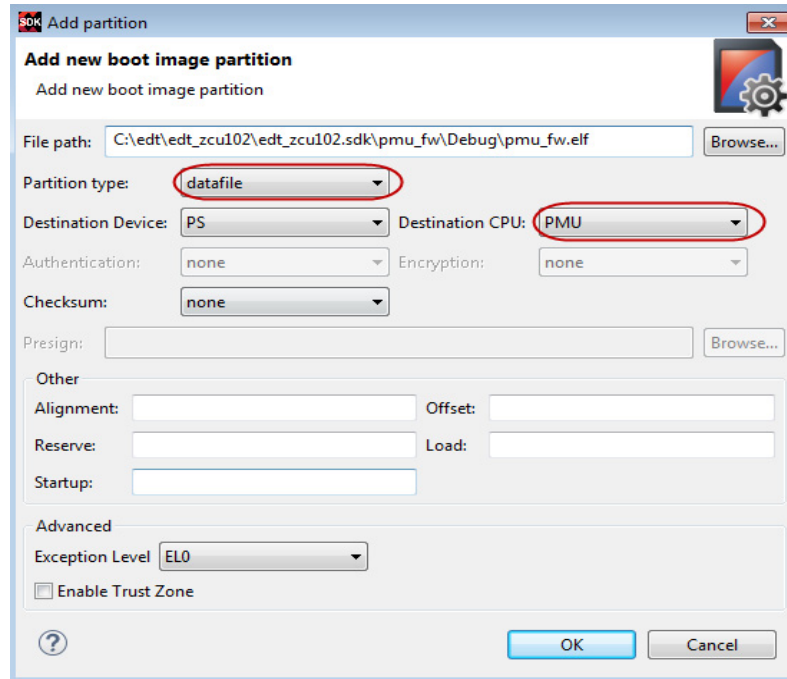

Figure 5-14: Add PMU Partition Details

5. The next partition to be added is the **ATF firmware**. For this, set the **Partition type** to **datafile**.
 - a. The ATF executable `bl31.elf` can be found in the PetaLinux images folder `<PetaLinux_project>/images/linux/`.
 - b. Select the **Destination Device** as **PS** and the **Destination CPU** as **A53 0**.
 - c. Set the Exception Level to **EL3** and select **Enable Trustzone**.

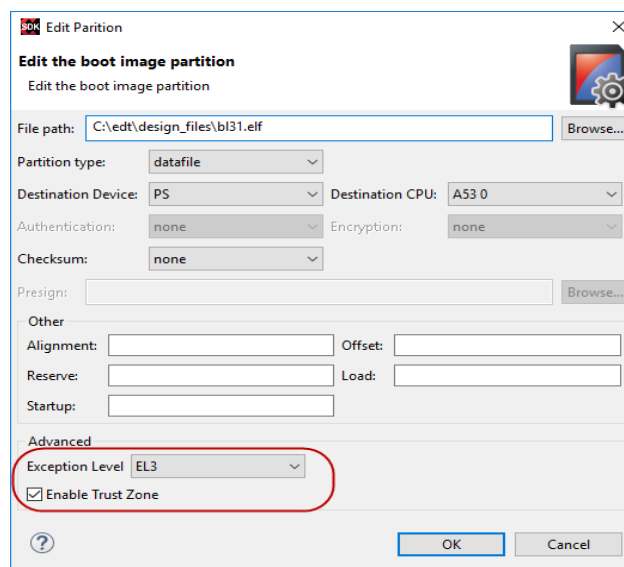

Figure 5-15: Add ATF Partition

- d. Click **OK**.
6. Click **Add** to add the R5 bare-metal executable.
 - a. Add the R5 executable and enable it in **lockstep** mode, as shown in the following image.
 - b. Click **OK**.

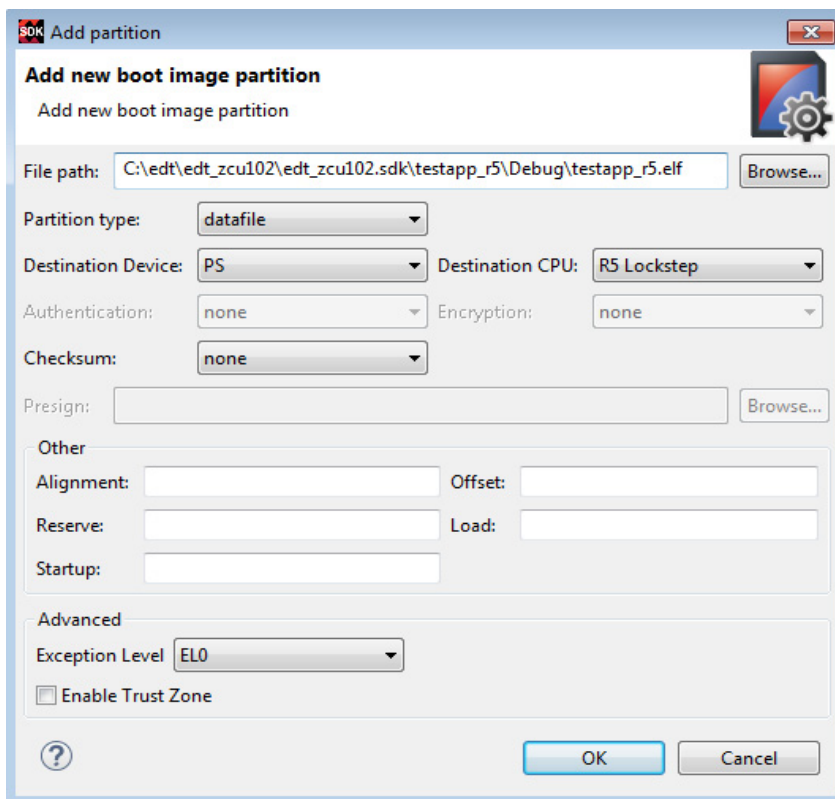

Figure 5-16: Add RPU Lockstep Image Partition

7. Click **Add** to add the U-boot partition. `u-boot.elf` can be found in `<PetaLinux_Project>/images/linux/`
 - a. For U-Boot, make the following selections:
 - Set the **Partition Type** to **datafile**.
 - Set the **Destination Device** to **PS**.
 - Set the **Destination CPU** to **A53 0**.
 - Set the Exception Level to **EL2**.

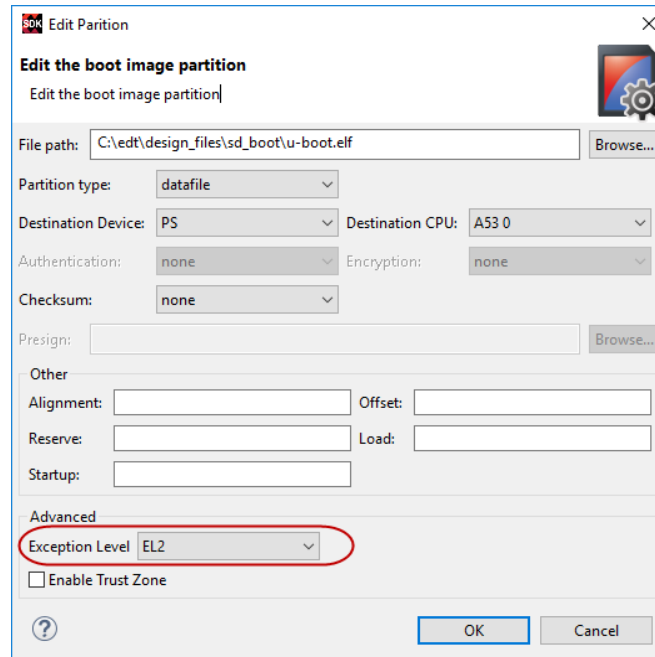

Figure 5-17: Add U-Boot Partition

- b. Click **OK**.
8. Click **Add** to add the `image.ub` Linux image file.
 - a. The `image.ub` image file can be found in PetaLinux project in the `images/Linux` directory.
 - b. For `image.ub`, make the following selections:
 - Set **Partition Type** to **datafile**.
 - Set the **Destination Device** to **PS**.
 - Set the **Destination CPU** to **A53 0**.
 - c. Enter `0x1E40000` as the **Offset**.
 - d. Leave Exception Level and Trustzone unselected.

Note: The Load Address setting in the above step is optional, and not required if the image is to be loaded to DDR using U-Boot. With Step 8.d, the partition will be written to the location (Load Address) in DDR by FSBL. In this example, both FSBL and U-Boot are copying the image to DDR. You can chose to load the image by either FSBL/U-Boot by setting the `partition_owner = U-Boot` (or FSBL) flag in the BIF file.



TIP: See [Create Linux Images using PetaLinux for QSPI Flash](#), to understand the offset value.

9. Click **OK** to go back to Create Boot Image wizard.
10. Click **Create Image** to create the `qspi_BOOT.bin` image.

You can also create `qspi_BOOT.bin` images using the BIF attributes and the Bootgen command. You can view the BIF attributes for this configuration by clicking **Preview BIF Changes**. For this configuration, the BIF file contains following attributes:

```
the_ROM_image:
{
  [bootloader,
  destination_cpu=a53-0]C:\edt\edt_zcu102\edt_zcu102.sdk\fsbl_a53\Debug\fsbl_a53.elf
  [destination_cpu = pmu]C:\edt\edt_zcu102\edt_zcu102.sdk\pmu_fw\
  Debug\pmu_fw.elf
  [destination_cpu = a53-0, exception_level=e1-3,
  trustzone]C:\edt\design_files\bl31.elf
  [destination_cpu =
  r5-lockstep]C:\edt\edt_zcu102\edt_zcu102.sdk\testapp_r5\Debug\testapp_r5.elf
  [destination_cpu = a53-0,
  exception_level=e1-2]C:\edt\design_files\qspi_boot\u-boot.elf

  [offset = 0x1E40000, load=0X10000000, destination_cpu =
  a53-0]C:\edt\design_files\image.ub
}
```

SDK calls the following Bootgen command to generate the `qspi_BOOT.bin` image for this configuration.

```
bootgen -image qspi_boot.bif -arch zynqmp -o C:\edt\qspi_BOOT.bin
```

Note: In this boot sequence, the First Stage Boot Loader (FSBL) loads PMU firmware. This is because the PMU Firmware was added as a **datafile** partition type. Ideally, the Boot ROM code can load the PMU Firmware for PMU as witnessed in the earlier section. For more details on PMU Firmware, refer to the “Platform Management” chapter in the *Zynq UltraScale+ MPSoC: Software Developers Guide* (UG1137) [Ref 6].

Running the Image in QSPI Boot Mode on ZCU102 Board

To test the image in this example, you will load the Boot image (`qspi_BOOT.bin`) onto QSPI on the ZCU102 board using the Program Flash utility in SDK. Alternately, you can use the XSDb debugger in Xilinx SDK.

1. In Xilinx SDK, select **Xilinx > Program Flash**.
2. In the Program Flash wizard, browse to and select the `qspi_BOOT.bin` image file that was created as a part of this example.
3. Select **qspi_dual_parallel** as the Flash type.
4. Set the **Offset** as **0** and select the FSBL ELF file (`fsbl_a53.elf`).
5. Ensure that a USB cable is connected between the USB-JTAG connector on ZCU102 target and the USB port on the Host machine using the following steps.
 - a. Set the **SW6 Boot mode switch** as shown in the following figure.
 - b. Turn on the board.

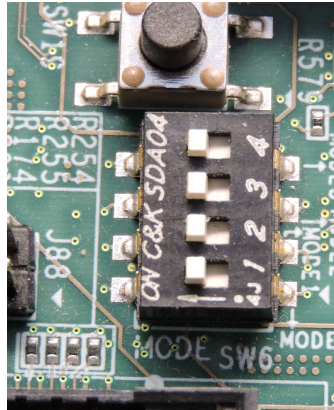

Figure 5-18: SW6 Switch Settings for JTAG Boot Mode

6. Click **Program** to start the process of programming the QSPI Flash with the `qspi_BOOT.bin` image.

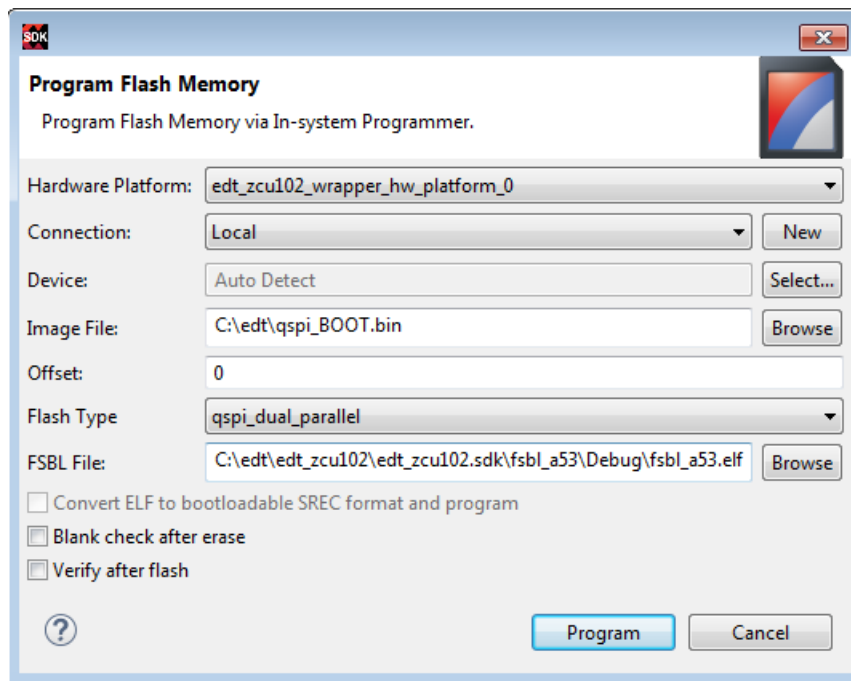

Figure 5-19: Program Flash Memory Dialog Box

Wait until you see the message “Flash Operation Successful” in the SDK Console, as shown in the following image.

```

Problems Tasks Console Properties SDK Terminal
Program Flash
Connected to hw_server @ TCP:127.0.0.1:3121
Available targets and devices:
Target 0 : jsn-JTAG-SMT2NC-210308A11A32
Device 0 : jsn-JTAG-SMT2NC-210308A11A32-04738093-0
|
Retrieving Flash info...
f probe 0 0 0
Performing Erase Operation...
Erase Operation successful.
INFO: [Xicom 50-44] Elapsed time = 24 sec.
Performing Program Operation...
0%...10%...20%...30%...40%...50%...60%...70%...80%...90%...100%
Program Operation successful.
INFO: [Xicom 50-44] Elapsed time = 1723 sec.
Flash Operation Successful
    
```

Figure 5-20: SDK Console Program Flash Messages

Set Up the ZCU102 Board

1. Connect Board USB-UART on Board to Host machine. Connect the Micro USB cable into the ZCU102 Board Micro USB port **J83**, and the other end into an open USB port on the host Machine.
2. Configure the Board to Boot in QSPI-Boot mode by switching **SW6** as shown in following figure.

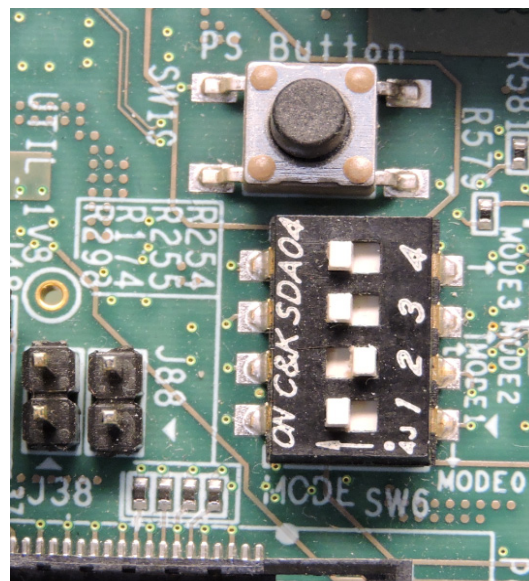

Figure 5-21: SW6 Switch Settings for QSPI Boot Mode

3. Connect 12V Power to the ZCU102 6-Pin Molex connector.
4. Start a terminal session, using Tera Term or Mini com, depending on the host machine being used, and the COM port and baud rate as shown in [Figure 5-22](#).

5. For port settings, verify the COM port in the device manager. There are four USB UART interfaces exposed by the ZCU102.
6. Select the COM port associated with the interface with the lowest number. In this case, for UART-0, select the COM port with interface-0.
7. Similarly, for UART-1, select COM port with interface-1.

Remember, R5 BSP has been configured to use UART-1, so R5 application messages will appear on the COM port with UART-1 terminal.

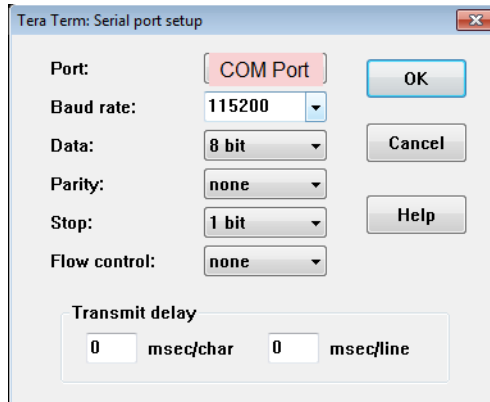

Figure 5-22: COM Port Settings for UART-1 Terminal

8. Turn on the ZCU102 Board using **SW1**.

At this point, you can see initial Boot sequence messages on your Terminal Screen representing UART-0.

You can see that the terminal screen configured for UART-1 also prints a message. This is the print message from the R-5 bare-metal Application running on RPU, configured to use UART-1 interface. This application is loaded by the FSBL onto RPU.

The bare-metal application has been modified to include the UART interrupt example. This application now waits in the WFI state until a user input is encountered from Keyboard in UART-1 terminal.



Figure 5-23: Hello World Displayed on UART-1 From R5-0

Meanwhile, the boot sequence continues on APU and the images loaded can be understood from the messages appearing on the UART-0 terminal. The messages are highlighted in the following figure.

```

Xilinx Zynq MP First Stage Boot Loader
Release 2018.2 Jul 4 2018 - 18:07:15
Reset Mode : System Reset
Platform: Silicon (4.0), Cluster ID 0x80000000
Running on A53-0 (64-bit) Processor, Device Name: XCZU9EG
PMC UADJ Configuration Successful
Board Configuration successful
Processor Initialization Done
===== In Stage 2 =====
QSPI 32 bit Boot Mode
QSPI is in Dual Parallel connection
QSPI is using 4 bit bus
FlashID=0x20 0xBB 0x20
MICRON 512M Bits
Multiboot Reg : 0x0
QSPI Reading Src 0x0, Dest FFFF1C40, Length EC0
.Image Header Table Offset 0x8C0
QSPI Reading Src 0x8C0, Dest FFFDD150, Length 40
.*****Image Header Table Details*****
Boot Gen Ver: 0x1020000
No of Partitions: 0x9
Partition Header Address: 0x440
Partition Present Device: 0x0
QSPI Reading Src 0x100, Dest FFFDD190, Length 40
.QSPI Reading Src 0x1140, Dest FFFDD1D0, Length 40
.QSPI Reading Src 0x1180, Dest FFFDD210, Length 40
.QSPI Reading Src 0x11C0, Dest FFFDD250, Length 40
.QSPI Reading Src 0x1200, Dest FFFDD290, Length 40
.QSPI Reading Src 0x1240, Dest FFFDD2D0, Length 40
.QSPI Reading Src 0x1280, Dest FFFDD310, Length 40
.QSPI Reading Src 0x12C0, Dest FFFDD350, Length 40
.QSPI Reading Src 0x1300, Dest FFFDD390, Length 40
.Initialization Success
===== In Stage 3, Partition No:1 =====
UnEncrypted data Length: 0x49DE
Data word offset: 0x49DE
Total Data word length: 0x49DE
Destination Load Address: 0xFFDC0000
Execution Address: 0xFFDC8C68
Data word offset: 0x82C0
Partition Attributes: 0x83E
QSPI Reading Src 0x20B00, Dest FFDC0000, Length 12778
.Partition 1 Load Success
===== In Stage 3, Partition No:2 =====
UnEncrypted data Length: 0x339
Data word offset: 0x339
Total Data word length: 0x339
Destination Load Address: 0xFFDD6CE0
Execution Address: 0x0
Data word offset: 0xCCA0
Partition Attributes: 0x83E
QSPI Reading Src 0x33280, Dest FFDD6CE0, Length CE4
.Partition 2 Load Success

```

QSPI BOOT MODE

Figure 5-24: Messages Appearing on UART-0 Terminal

The U-Boot then loads Linux Kernel and other images on Arm Cortex-A53 APU in SMP mode. The terminal messages indicate when U-Boot loads Kernel image and the kernel start up to getting a user interface prompt in Linux Kernel. The Kernel loading and starting sequence can be seen in following figure.

```
reading image.ub
75735640 bytes read in 4924 ms (14.7 MiB/s)
## Loading kernel from FIT Image at 10000000 ...
Using 'conf@1' configuration
Trying 'kernel@0' kernel subimage
  Description: Linux Kernel
  Type: Kernel Image
  Compression: uncompressed
  Data Start: 0x100000d8
  Data Size: 13171200 Bytes = 12.6 MiB
  Architecture: AArch64
  OS: Linux
  Load Address: 0x00080000
  Entry Point: 0x00080000
  Hash algo: sha1
  Hash value: f095d304a568f560fbc4e83dddaa1600b6ceb7d8
Verifying Hash Integrity ... sha1+ OK
## Loading ramdisk from FIT Image at 10000000 ...
Using 'conf@1' configuration
Trying 'ramdisk@0' ramdisk subimage
  Description: ramdisk
  Type: RAMDisk Image
  Compression: uncompressed
  Data Start: 0x10c9a378
  Data Size: 62520042 Bytes = 59.6 MiB
  Architecture: AArch64
  OS: Linux
  Load Address: unavailable
  Entry Point: unavailable
  Hash algo: sha1
  Hash value: 91828eafd9bd095cd965ecef79f863f8dd90fda
Verifying Hash Integrity ... sha1+ OK
## Loading fdt from FIT Image at 10000000 ...
Using 'conf@1' configuration
Trying 'fdt@0' fdt subimage
  Description: Flattened Device Tree blob
  Type: Flat Device Tree
  Compression: uncompressed
  Data Start: 0x10c8fbd0
  Data Size: 42737 Bytes = 41.7 KiB
  Architecture: AArch64
  Hash algo: sha1
  Hash value: fe11097c8fedecdee3e4bf31d27370e536896e85
Verifying Hash Integrity ... sha1+ OK
Booting using the fdt blob at 0x10c8fbd0
Loading Kernel Image ... OK
Loading Ramdisk to 04460000, end 07fffaea ... OK
Loading Device Tree to 000000004452000, end 00000000445f6f0 ... OK

Starting kernel ...

[ 0.000000] Booting Linux on physical CPU 0x0
```

Figure 5-25: Kernel Loading and Starting Sequence

9. Wait until Linux loads on the Board.

Boot Sequence for QSPI-Boot Mode Using JTAG

Zynq UltraScale+ MPSoC supports many ways to load the boot image. One way is using the JTAG interface. This example XSC T session demonstrates how to download a BOOT image file (`qspi_BOOT.bin`) in QSPI using the XSDB debugger. After the QSPI is loaded, the `qspi_BOOT.bin` image executes in the same way as QSPI Boot mode in Zynq UltraScale+. You can use the same XSC T session or the System Debugger for debugging similar Boot flows.

The following sections demonstrate the basic steps involved in this Boot mode.

Setting Up the Target

1. Connect a USB cable between the USB-JTAG J2 connector on the target and the USB port on the host machine.
2. Set the board to JTAG Boot mode by setting the **SW6** switch, as shown in the following figure.

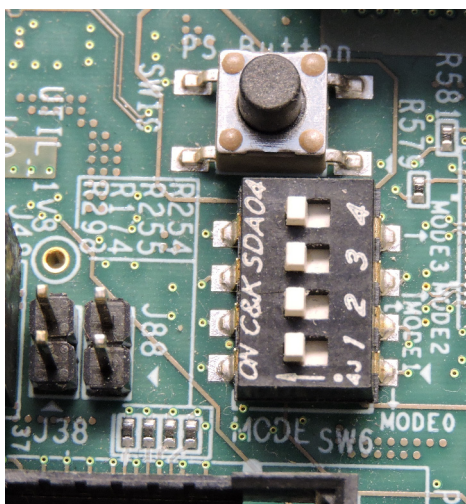



Figure 5-26: SW6 Switch Settings for JTAG Boot Mode

3. Power on the Board using switch **SW1**.

Open the XSC T Console in SDK by clicking the XSC T button . Alternatively, you can also open the XSC T console by selecting **Xilinx > XSC T Console**.

4. In the XSC T console, connect to the target over JTAG using the `connect` command:

```
xsct% connect
```

The `connect` command returns the channel ID of the connection.

- The `targets` command lists the available targets and allows you to select a target using its ID.

The targets are assigned IDs as they are discovered on the JTAG chain, so the IDs can change from session to session.

Note: For non-interactive usage such as scripting, you can use the `-filter` option to select a target instead of selecting the target using its ID.

```
xsct% targets
```

The targets are listed as shown in the following figure.

```

XSCT Process
xsct% targets
 1 PS TAP
 2 PMU
 3 PL
 4 PSU
 5 RPU (Reset)
 6 Cortex-R5 #0 (RPU Reset)
 7 Cortex-R5 #1 (RPU Reset)
 8 APU (L2 Cache Reset)
 9 Cortex-A53 #0 (APU Reset)
10 Cortex-A53 #1 (APU Reset)
11 Cortex-A53 #2 (APU Reset)
12 Cortex-A53 #3 (APU Reset)
xsct%

```

Figure 5-27: XSCT Targets

Load U-Boot Using XSCT/XSDB

- Download the `u-boot` application on Cortex-A53 #0 using the following commands:

Disable Security gates to make PMU MB target visible to Debugger

```

xsct% targets -set -filter {name =~ "PSU"}
xsct% mwr 0xffca0038 0x1ff
xsct% targets
#Disable Security gates to view PMU MB target
targets -set -filter {name =~ "PSU"}
#By default, JTAGsecurity gates are enabled
#This disables security gates for DAP, PLTAP and PMU.
mwr 0xffca0038 0x1ff
after 500

```

Verify if the PMU MB target is listed under the PMU device. Now, load and run PMUFW

```
xsct% targets -set -filter {name =~ "MicroBlaze PMU"}
```



```
xsct% dow {C:\edt\edt_zcu102\edt_zcu102.sdk\pmu_fw\Debug\pmu_fw.elf}
xsct% con
```

Now, reset APU Cortex-A53 Core 0 to load and run FSBL

```
xsct% targets -set -filter {name =~ "Cortex-A53 #0"}
xsct% rst -processor
```



TIP: `rst -processor` clears the reset on an individual processor core.

This step is important, because when Zynq UltraScale+ boots up in JTAG bootmode, all the APU and RPU cores are held in reset. You must clear resets on each core before performing debugging on these cores. You can use the `rst` command in XSC T to clear the resets.

Note: `rst -cores` clears resets on all the processor cores in the group (such as APU or RPU) of which the current target is a child. For example, when A53 #0 is the current target, `rst -cores` clears resets on all the A53 cores in APU.

Load and run FSBL

```
xsct% dow {C:\edt\edt_zcu102\edt_zcu102.sdk\fsbl_a53\Debug\fsbl_a53.elf}
xsct% con
```

Verify FSBL messages on Serial Terminal and stop FSBL after couple of seconds

```
xsct% stop
```

Load and Run ATF

```
xsct% dow {C:\edt\design_files\b131.elf}
xsct% con
xsct% stop
```

2. Configure a serial terminal (Tera Term, Mini com, or SDK Serial Terminal interface for UART-0 USB-serial connection).
3. For serial terminal settings, see [Figure 5-22](#).

```
xsct% dow {C:\edt_zcu102\u-boot.elf}
Downloading Program -- C:/edt_zcu102/u-boot.elf
section, .data: 0x08000000 - 0x0806c70f
100% OMB 0.1MB/s 00:03
Setting PC to Program Start Address 0x08000000
Successfully downloaded C:/edt_zcu102/u-boot.elf
xsct%
xsct%
```

Figure 5-28: Verify the Image on the ZCU102 Board

4. Load and run U-Boot

```
xsct% dow {C:\edt\design_files\sd_boot\u-boot.elf}
```

5. Run U-Boot, using the `con` command in XSDB.

```
xsct% con
```

6. In the target serial terminal, press any key to stop the U-Boot auto boot.

7. Stop the core using the `stop` command in XSDB.

```
xsct% stop
```

Load Boot.bin in DDR Using XSDB

1. Download the Boot.bin binary into DDR on ZCU102. Use the same Boot.bin created for QSPI boot mode.

```
xsct% dow -data {C:\edt\qspi_BOOT.bin} 0x2000000
```

2. Now continue the U-Boot again, using the `con` command in XSDB.

```
xsct% con
```

Load the Boot.bin Image in QSPI Using U-Boot

1. Execute the following commands in the U-Boot console on the target terminal. These commands erase QSPI and then write the Boot.bin image from DDR to QSPI.

```
ZynqMP> sf probe 0 0 0  
ZynqMP> sf erase 0 0 0x1E00000  
ZynqMP> sf write 0x10000000 0x0 ${filesize}
```

2. After successfully writing the image to QSPI, turn off the board and set up the ZCU102 board as described in [Set Up the ZCU102 Board, page 87](#).

You can see Linux loading on the UART-0 terminal and the R5 application executing in the UART-1 terminal.

This chapter focused mostly on system boot and different components related to system boot. In the next chapter, you will focus on applications, Linux and Standalone (bare-metal) applications which will make use of PS peripherals, PL IPs, and processing power of APU Cores and RPU cores.

Boot Sequence for USB Boot Mode

Zynq UltraScale+ MPSoC also supports USB Slave Boot Mode. This is using the USB DFU Device Firmware Upgrade (DFU) Device Class Specification of USB. Using a standard update utility such as [OpenMoko's DFU-Util](#), you will be able to load the newly created image on Zynq UltraScale+ via the USB Port. The following steps list the required configuration to load Boot images using this Boot mode. The DFU Utility is also shipped with Xilinx SDK and PetaLinux.

Configure FSBL to Enable USB Boot Mode

There are few changes required in FSBL to enable USB Boot Mode. USB boot mode support increases the footprint of FSBL (by approximately 10 KB). Since it is intended mostly during initial development phase, its support is disabled by default to conserve OCM space. In this section, you will modify the FSBL to enable the USB Boot Mode. Considering the FSBL project is used extensively throughout this tutorial, we will not modify the existing FSBL project. Instead, this section will make use of new FSBL project.

Create First Stage Boot Loader for Arm Cortex-A53-Based APU

1. In SDK, select **File > New > Application Project** to open the New Project wizard.
2. Use the information in the table below to make your selections in the wizard.

Table 5-1: Wizard Properties and Commands

Wizard Screen	System Properties	Setting or Command to Use
Application Project	Project Name	fsbl_usb_boot
	Use Default Location	Select this option
	OS Platform	Standalone
	Hardware Platform	edt_zcu102_wrapper_hw_platform_0
	Processor	psu_cortexa53_0
	Language	C
	Compiler	64-bit
	Hypervisor Guest	No
	Board Support package	Select Use Existing and select a53_bsp
Templates	Available Templates	Zynq MP FSBL

3. Click Finish.
4. In the Project Explorer tab, expand the fsbl_usb_boot project and open `xfbsbl_config.h` from:

```
fsbl_usb_boot > src > xfbsbl_config.h
```

5. In `xfbsbl_config.h` change or set following settings:

```
#define FSBL_QSPI_EXCLUDE_VAL (1U)
#define FSBL_SD_EXCLUDE_VAL (1U)
#define FSBL_USB_EXCLUDE_VAL (0U)
```

6. Use **CTRL + S** to save these changes.
7. Re-build FSBL (fsbl_usb_boot).

Creating Boot Images for USB Boot

In this section, you will create the Boot Images to be loaded, via USB using DFU utility. Device Firmware Upgrade (DFU) is intended to download and upload firmware to/from devices connected over USB. In this boot mode, the Boot loader (FSBL) and the PMUFW which are loaded by Boot ROM are copied to Zynq Ultrascale+ On Chip Memory (OCM) from Host Machine USB port using DFU Utility. The size of OCM (256 KB) limits the size of boot image downloaded by BootROM in USB boot mode. Considering this, and subject to size requirement being met, only FSBL and PMUFW are stitched into the first `Boot.bin`, which is copied to OCM. Rest of the Boot partitions will be stitched in another Boot image and copied to DDR to be loaded by the FSBL which is already loaded and running at this stage. Follow the below steps to create Boot images for this boot mode.

1. In SDK, select **Xilinx > Create Boot Image**.
2. Select `fsbl_usb_boot.elf` and `pmu_fw.elf` partitions and set them as shown in the following figure.

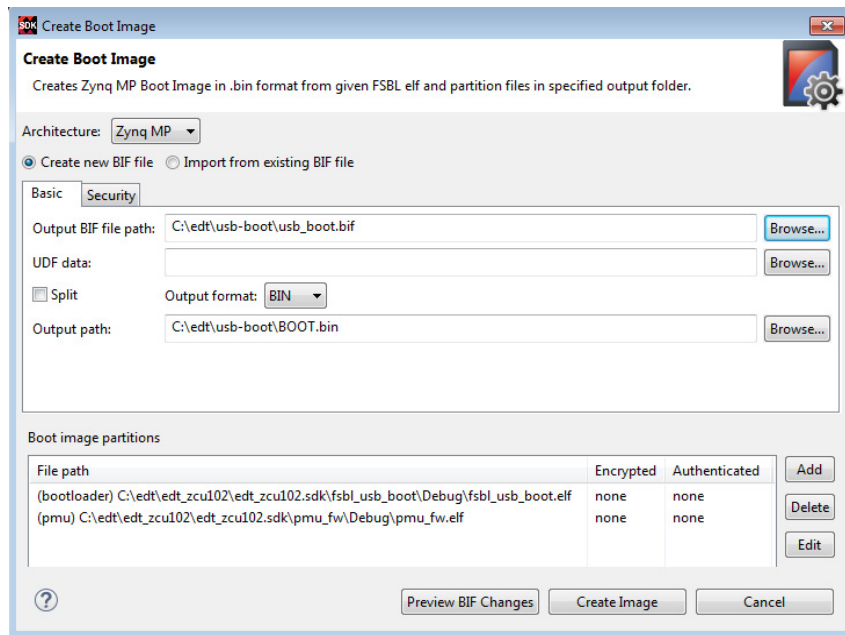

Figure 5-29: Create Boot Image for USB Boot

3. Ensure that PMU Partition is set to be loaded by BootROM.
4. Click on Create Image to generate `BOOT.bin`.

Modifying PetaLinux U-Boot

Modify PetaLinux U-Boot so that it can load the `image_ub` image. The Device tree needs to be modified to set USB in the Peripheral mode. The default PetaLinux configuration is set for the USB in Host mode.

For this, follow the below steps to modify `system-user.dtsi` in the PetaLinux Project `<PetaLinux-project>/project-spec/meta-user/recipes-bsp/device-tree/files/system-user.dtsi`.

1. Add the following to `system-user.dtsi`, so that it looks like:

```
/include/ "system-conf.dtsi"
/ {
    gpio-keys {
        sw19 {
            status = "disabled";
        };
    };
    leds {
        heartbeat_led {
            status = "disabled";
        };
    };
    &dwc3_0 {
        dr_mode = "peripheral";
        maximum-speed = "super-speed";
    };
};
```

The modified `system-user.dtsi` file can be found in `C:\edt\usb_boot` released with tutorial.

2. Build PetaLinux with these changes.

```
$ petalinux-build
```

The following steps describe how to create a `usb_boot.bin` comprising rest of the partitions.

Note: Copy the newly generated U-Boot to `C:\edt\usb-edt\`. The `u-boot.elf` is also available in [Design Files for This Tutorial](#).

1. In SDK, select **Xilinx > Create Boot Image**.
2. Select FSBL and rest of the partitions and set them as shown in the following figure. For this you can also choose to import the BIF File from SD Boot Sequence.

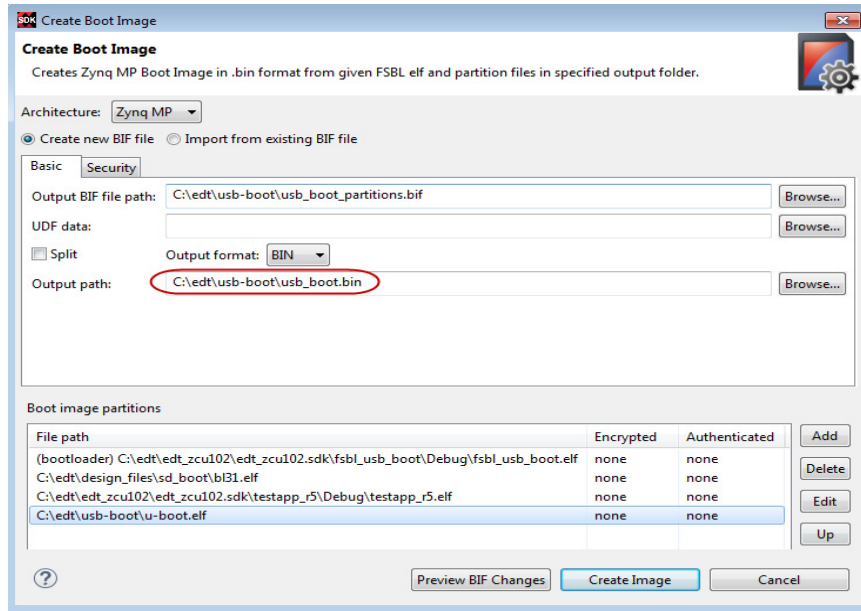

Figure 5-30: Create Boot Image with Rest of the Partitions

- Notice that PMUFW partition is not required in this image, as it will be loaded by the Boot ROM before this image (`usb_boot.bin`) is loaded.
- Click on Create Image to generate `usb_boot.bin`.

Note: In addition to `BOOT.bin` and `usb_boot.bin`, the Linux image like `image.ub` is required to boot till Linux. This `image.ub` will be loaded by DFU utility separately.

Boot using USB Boot

In this section you will load the boot images on ZCU102 target using DFU utility. Before you start, set the board connections as shown below:

- Set ZCU102 for USB Boot mode by setting SW6 (1-OFF, 2-OFF, 3-OFF, and 4-ON), as shown below:

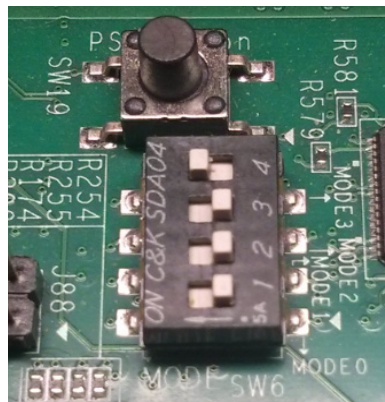

Figure 5-31: SW6 Settings for USB Boot Mode

2. Connect a USB 3.0 Cable to J96 USB 3 ULPI Connector, and the other end of the Cable to USB port on Host Machine.
3. Connect a USB Micro cable between USB-UART port on Board (J83) and Host Machine.
4. Start a terminal session, using Tera Term or Minicom depending on the host machine being used, as well as the COM port and baud rate for your system, as shown in [Figure 5-31](#).
5. Power ON the board.

The following steps will load the boot images via USB using DFU utility, which can be found in `SDK\2018.2\tps\lnx64\dfu-util-0.9`.

Alternatively you can also install DFU utility on Linux using Package Manager supported by Linux Distribution being used.

Boot Commands for Linux Host Machine

1. Check if the DFU can detect the USB target.

```
$ sudo dfu-util -l
```

The USB device should be enumerated with VendorId : ProductId which is 03fd:0050. You should see something like below:

```
Found DFU: [03fd:0050] ver=0100, devnum=30, cfg=1, intf=0, alt=0, name="Xilinx DFU Downloader", serial="2A49876D9CC1AA4"
```

Note: If you do not see the 'Found DFU' message, verify the connection and retry.

2. Now download the `BOOT.bin` that was created in [Creating Boot Images for USB Boot](#).

```
$ sudo dfu-util -d 03fd:0050 -D <USB_Boot_Image_Path>/Boot.bin
```

Verify from Serial Terminal if the FSBL is loaded successfully.

3. Now download the `usb_boot.bin`. Before this start another terminal session for UART-1 serial console.

```
$ sudo dfu-util -d 03fd:0050 -D <USB_Boot_Image_Path>/usb_boot.bin
```

Check UART 0 terminal and wait until U-Boot loads.

4. On U-Boot prompt, type `Enter` to terminate autoboot. Verify from the UART1 console that the R5 application is also loaded successfully.
5. In U-Boot console start `DFU_RAM` to enable downloading Linux Images

```
U-boot> run dfu_ram
```

6. Download Linux Image `Image.ub` using following Command from Host Machine Terminal:

```
$ sudo dfu-util -d 03fd:0300 -D <PetaLinux_project>/images/linux/image.ub -a 0
```

7. Now execute CTRL+C on U-Boot console to stop dfu_ram.
8. Run bootm command from U-Boot Console.

```
U-boot> bootm
```

9. Verify that Linux loads successfully on the target

Note: In this example, `image.ub` is copied to DDR location based on `#define DFU_ALT_INFO_RAM` settings in U-Boot configuration. The same can be modified to copy other image files to DDR location. Then, if required, these images can be copied to QSPI using U-Boot commands listed in [Boot Sequence for QSPI-Boot Mode Using JTAG](#).

Boot Commands for Windows Host Machine

1. In SDK, Select **Xilinx > Launch Shell**.
2. In Shell, use Check if the DFU can detect the USB target

```
> dfu-util.exe -l
```

Note: `dfu-util.exe` can be found in

```
<SDK_Installation_path>\SDK\2018.2\tps\Win64\dfu-util-0.9\dfu-util.exe
```

3. The USB device should be enumerated with VendorId : ProductId which is 03fd:0050

Note: If you do not see the message starting with "Found DFU", download and install "zadig" software. Open the software and click on options and select "List all devices". Select device "Xilinx Dfu Downloader" and click on Install driver tab.

4. Now download the Boot.bin that was created in [Creating Boot Images for USB Boot](#).

```
$ dfu-util.exe -d 03fd:0050 -D BOOT.bin
```

5. Verify from Serial Terminal (UART 0) that FSBL is loaded successfully.

6. Now download the `usb_boot.bin`. Before this start another terminal session for UART-1 serial console.

```
$ dfu-util.exe -d 03fd:0050 -D usb_boot.bin
```

7. On U-Boot prompt type Enter to terminate auto-boot. Verify from UART1 console that the R5 application is also loaded successfully.

Note: At this point, use Zadig utility to install drivers for "Usb download gadget" with device ID 03fd:0300. Without this, zadig software does not show "Xilinx DFU Downloader" after booting U-Boot on target.

8. In U-Boot console start DFU_RAM to enable downloading Linux Images

```
U-boot> run dfu_ram
```

9. Download Linux Image `image.ub` using following Command from Host Machine Terminal

```
$ dfu-util.exe -d 03fd:0300 -D image.ub -a 0
```

10. Run bootm command from U-Boot Console.

```
U-boot> bootm
```

11. Verify that Linux loads successfully on the target.

Secure Boot Sequence

The secure boot functionality in Zynq UltraScale+ MPSoC allows you to support confidentiality, integrity, and authentication of partitions. Secure boot is accomplished by combining the Hardware Root of Trust (HROT) capabilities of the Zynq UltraScale+ device with the option of encrypting all boot partitions. The HROT is based on the RSA-4096 asymmetric algorithm in conjunction with SHA-3/384, which is hardware accelerated, or SHA-2/256, implemented as software. Confidentiality is provided using 256 bit Advanced Encryption Standard - Galois Counter Mode (AES-GCM). This section focuses on how to use and implement the following:

- Hardware Root of Trust with Key Revocation
- Partition Encryption with Differential Power Analysis (DPA) Countermeasures
- Black Key Storage using the Physically Unclonable Function (PUF)

The section [Secure Boot System Design Decisions](#) outlines high level secure boot decisions which should be made early in design development. The [Hardware Root of Trust](#) section discusses the use of a Root of Trust (RoT) in boot. The [Boot Image Confidentiality and DPA](#) section discusses methods to use AES encryption.

The [Boot Image Confidentiality and DPA](#) section discusses the use of the operational key and key rolling techniques as countermeasures to a DPA attack. Changing the AES key reduces the exposure of both the key and the data protected by the key.

A red key is a key in unencrypted format. The [Black Key Storage](#) section provides a method for storing the AES key in encrypted, or black format. Black key store uses the physically unclonable function (PUF) as a Key Encryption Key (KEK).

The [Practical Methods in Secure Boot](#) section provides steps to develop and test systems that use AES encryption and RSA authentication.

Secure Boot System Design Decisions

The following are device level decisions affecting Secure Boot:

- Boot Mode
- AES Key Storage Location
- AES Storage State (encrypted or unencrypted)
- Encryption and Authentication requirements
- Key Provisioning

The boot modes which support secure boot are Quad Serial Peripheral Interface (QSPI), SD, eMMC, and NAND. The AES key is stored in either eFUSEs (encrypted or unencrypted), Battery Backed Random Access Memory (BBRAM) (unencrypted only), or in external NVM (encrypted only).

In Zynq UltraScale+ MPSoC, partitions can be encrypted and/or authenticated on a partition basis. Xilinx generally recommends that all partitions be RSA authenticated. Partitions that are open source (U-Boot, Linux), or do not contain any proprietary or confidential information, typically do not need to be encrypted. In systems in which there are multiple sources/suppliers of sensitive data and/or proprietary IP, encrypting the partitions using unique keys may be important.

DPA resistance requirements are dictated by whether the adversary has physical access to the device.

[Table 5-2](#) can be a good reference while deciding on features required to meet a specific secure system requirement. Next sections will discuss the features in more detail.

Table 5-2: System Level Security Requirements

System Consideration/ Requirement	Zynq UltraScale+ Feature
Ensure that only the users SW and HW runs on the device	HWROT
Guarantee that the users SW and HW are not modified	HWROT
Ensure that an adversary cannot clone or reverse engineer SW/HW	Boot Image Confidentiality
Protect sensitive data and proprietary Intellectual Property (IP)	Boot Image Confidentiality
Ensure that Private Key (AES key) is protected against side channel attacks	DPA Protections
Private/Secret keys (AES key) is stored encrypted at rest	Black Key Storage

Hardware Root of Trust

Root of trusts are security primitives for storage (RTS), integrity (RTI), verification (RTV), measurement (RTM), and reporting (RTR). RoT consists of hardware, firmware, and software. The HROT has advantages over software RoTs because the HROT is immutable, has a smaller attack surface, and the behavior is more reliable.

The HROT is based on the CSU, eFUSEs, BBRAM, and isolation elements. The HROT is responsible for validating that the operating environment and configuration have not been modified. The RoT acts as an anchor for boot, so an adversary can not insert malicious code before detection mechanisms start.

Firmware and software run on the HROT during boot. Zynq UltraScale provides immutable BootROM code, a first stage boot loader, device drivers, and the XILSKEY and XILSECURE libraries which run on the HROT. These provide a well-tested, proven in use API so that developers do not create security components from scratch with limited testing.

Data Integrity

Data integrity is the absence of corruption of hardware, firmware and software. Data integrity functions verify that an adversary has not tampered with the configuration and operating environment.

Zynq UltraScale+ verifies the integrity of partition(s) using both symmetric key (AES-GCM) and asymmetric key (RSA) authentication. RSA uses a private/public key pair. The fielded embedded system only has the public key. Theft of the public key is of limited value since it is not possible, with current technology, to derive the private key from the public key. Encrypted partitions are also authenticated using the Galois Counter Mode (GCM) mode of AES.

In the secure boot flow, partitions are first authenticated and then decrypted if necessary.

Authentication

Figure 5-32 shows RSA signing and verification of partitions. From a secure facility, the SDK Bootgen tool signs partitions, using the private key. In the device, the ROM verifies the FSBL and either the FSBL or U-Boot verifies the subsequent partitions, using the public key. Primary and secondary private/public key pairs are used. The function of the primary private/public key pair is to authenticate the secondary private/public key pair. The function of the secondary key is to sign/verify partitions.

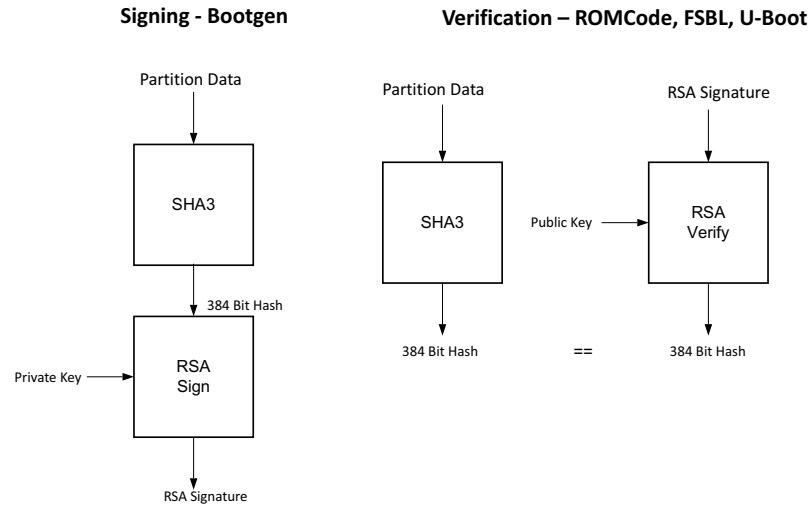

Figure 5-32: Zynq UltraScale+ RSA Authentication

To sign a partition, Bootgen first calculates the SHA3 of the partition data. The 384 bit hash is then RSA signed using the private key. The resulting RSA signature is placed in the authentication certificate. In the image, each signed partition has partition data followed by an authentication certificate which includes the RSA signature.

Verification of the FSBL is handled by the CSU ROM code. To verify the subsequent partitions, the FSBL or U-Boot uses the XILSECURE library.

There is a debug mode for authentication called bootheader authentication. In this mode of authentication, the CSU ROM code does not check the primary public key digests, the session key ID or the key revocation bits stored in the device eFUSES. Therefore, this mode is not secure. However, it is useful for testing and debugging as it does not require programming of eFUSES. This tutorial uses this mode. However, fielded systems should not use boot header authentication. The example BIF file for a fully secured system is included at the end of this section.

Boot Image Confidentiality and DPA

AES is used to ensure confidentiality of sensitive data and IP. Zynq UltraScale+ uses AES Galois Counter Mode (GCM). Zynq UltraScale+ uses a 256 AES bit key. The principle AES enhancements provided by Zynq UltraScale+ are increased resistance to Differential Power Analysis (DPA) attacks and the availability of AES encryption/decryption post boot.

Bootgen and FSBL software support AES encryption. Private keys are used in AES encryption, and AES encryption is done by Bootgen using the key files. The key files can be generated by Bootgen or OpenSSL. The use of the operational key limits the exposure of the device key. The use of the operational key in key rolling is discussed in the next section. To maintain Boot image confidentiality, Encrypted Boot images can be created using Bootgen. Software examples to program keys to BBRAM and eFUSE are also available in Xilinx SDK. One such example is discussed in [Practical Methods in Secure Boot](#).

DPA Protections

Key rolling is used for DPA resistance. Key rolling and black key store can be used in the same design. In key rolling, software and bitstream is broken up into multiple data blocks, each encrypted with a unique AES key. The initial key is stored in BBRAM or eFUSE NVM. Keys for successive data blocks are encrypted in the previous data block. After the initial key, the key update register is used as the key source.

A 96 bit initialization vector is included in the NKY key file. The IV uses 96 bits to initialize AES counters. When key rolling is used, a 128 bit IV is provided in the bootheader. The 32 least significant bits define the block size of data to decrypt using the current key. The block sizes following the initial block defined in the IV are defined as attributes in the Bootgen Image Format (BIF) file.

An efficient method of key rolling uses the operational key. With the operational key, Bootgen creates an encrypted secure header with the user specified operational key and the first block IV. The AES key in eFUSE or BBRAM is used only to decrypt the 384 bit secure header with the 256 bit operational key. This limits the exposure of the device key to DPA attacks.

Black Key Storage

The PUF enables storing the AES key in encrypted (black) format. The black key can be stored either in eFUSES or in the bootheader. When needed for decryption, the encrypted key in eFUSES or the bootheader is decrypted using the PUF generated key encrypting key (KEK).

There are two steps in using the PUF for black key storage. In the first, PUF registration software is used to generate PUF helper data and the PUF KEK. The PUF registration data allows the PUF to re-generate the identical key each time the PUF generates the KEK. For more details on the use of PUF registration software, see [PUF Registration - Boot Header Mode](#). For more information on PUF Registration - eFUSE mode, see *Programming BBRAM and eFUSES* (XAPP1319) [Ref 13].

The helper data and encrypted user key must both be stored in eFUSES if the PUF eFUSE mode is used, and in the bootheader if the PUF Bootheader mode is used. The procedure for the PUF bootheader mode is discussed in [Using PUF in Bootheader Mode](#). For the procedure to use PUF in eFUSE mode, see *Programming BBRAM and eFUSES* (XAPP1319) [Ref 13].

This tutorial uses PUF Bootheader Mode as it does not require programming of eFUSES, and is therefore useful for test and debug. However, the most common mode is PUF eFUSE mode, as the PUB Bootheader mode requires a unique run of bootgen for each and every device. The example BIF file for a fully secured system is included at the end of the [Secure Boot Sequence](#) section demonstrates the PUF eFUSE mode.

Practical Methods in Secure Boot

This section outlines the steps to develop secure boot in a Zynq UltraScale+ system. Producing a secure embedded system is a two-step process. In the first phase, the cryptographic keys are generated and programmed into NVM. In the second phase, the secure system is developed and tested. Both steps use the Xilinx Software Design Kit (SDK) to create software projects, generate the image, and program the image. For the second phase, a test system can be as simple as `fsbl.elf` and `hello.elf` files. In this section, you will use the same images used in [Boot Sequence for SD-Boot](#), but this time the images will be assembled together, and have the secure attributes enabled as part of the secure boot sequence.

This section starts by showing how to generate AES and RSA keys. Following key generation, systems using the advanced AES and RSA methods are developed and tested. Keys generated in this section are also included in the [Design Files for This Tutorial](#), released with this tutorial.

The methods used to develop AES functionality are provided in the following sections:

- [Generating all of the AES keys](#)
- [Enabling Encryption Using Key Rolling](#)
- [Enable use of an Operational Key](#)
- AES key in eFUSE
- [Using the PUF](#)

The [Creating RSA Private/Public Key Pairs](#) section provides the steps to authenticate all partitions loaded at boot. This section also shows how to revoke keys.

A requirement in the development of a secure system is to add security attributes which are used in image generation. SDK's Bootgen generates a Boot Image Format (BIF) file. The BIF file is a text file. In its simplest form, the BIF is a list of partitions to be loaded at boot. Security attributes are added to the BIF to specify cryptographic functionality. In most cases, the Bootgen GUI (Create Boot Image wizard) is used to generate the BIF file. In some cases, adding security attributes requires editing the Bootgen generated BIF file. In Create Boot Image Wizard in Xilinx SDK, after the Security tab is selected, the Authentication and Encryption tabs are used to specify security attributes.

After implementing AES and RSA cryptography in secure boot, a Boot test is done. The system loads successfully and displays the FSBL messages on the terminal. These messages indicate the cryptographic operations performed on each partition. [Appendix A, Debugging Problems with Secure Boot](#) provides steps that are required to use, if the secure boot test fails.

Sample Design Overview

The sample design demonstrates loading various types of images into the device. It includes loading a FSBL, PMU Firmware, U-Boot, Linux, RPU software and a PL configuration image. In this sample, all of these images are loaded by the FSBL which performs all authentication and decryption. This is not the only means of booting a system. However, it is the simple and secure method, as of 2018.2.

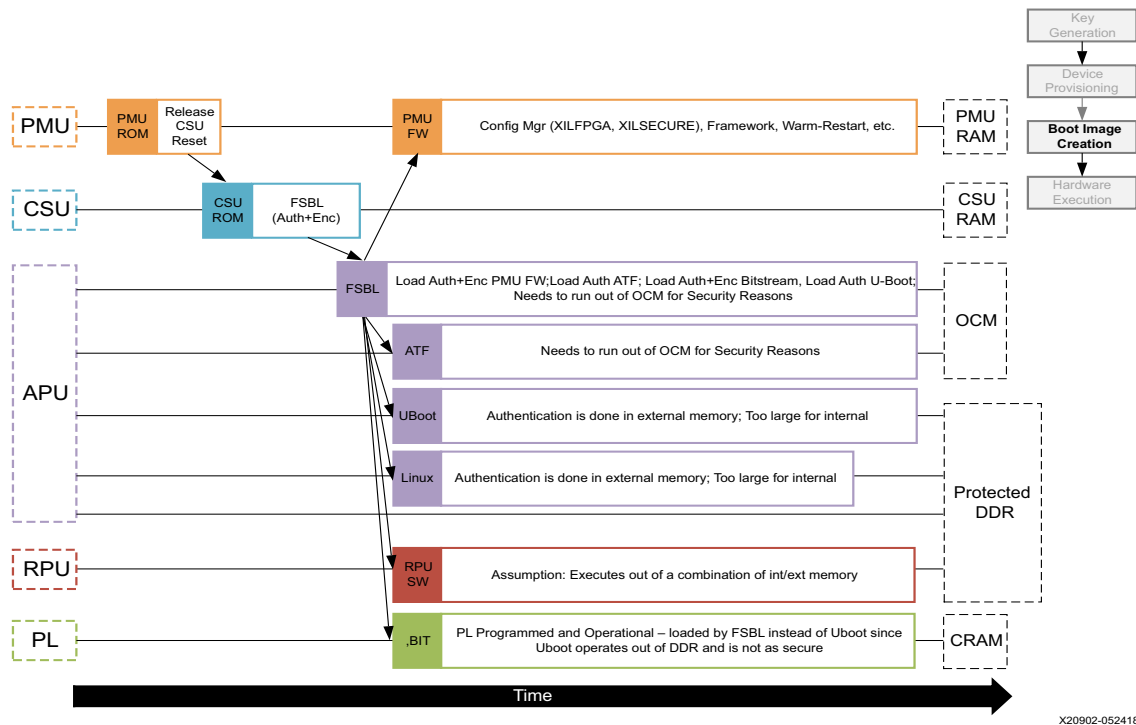

Figure 5-33: Sample Design Overview

Different sections within the boot image have different levels of security and are loaded into different locations. The following table explains the contents of the final boot image.

Table 5-3: Final Boot Image with Secure Attributes

Binary	RSA Authenticated	AES Encrypted	Exception Level	Loader
FSBL	Yes	Yes	EL3	CSU ROM
PMU Firmware	Yes	Yes	NA	FSBL
PL Bitstream	Yes	Yes	NA	FSBL
Arm Trusted Firmware (ATF)	Yes	No	EL3	FSBL
R5 Software	Yes	Yes	NA	FSBL
U-Boot	Yes	No	EL2	FSBL

Table 5-3: Final Boot Image with Secure Attributes (Cont'd)

Binary	RSA Authenticated	AES Encrypted	Exception Level	Loader
Linux	Yes	No	EL1	FSBL

Notes:

- In a Secure boot sequence PMU image is loaded by FSBL. Using the BootROM/CSU to load the PMU firmware introduces a security weakness as the key/IV combination is used twice. First to decrypt the FSBL and then again to decrypt the PMU image. This is not allowed for the secure systems.
- As of 2018.2, U-Boot does not perform a secure authenticated loading of Linux. So instead of U-Boot, FSBL loads the Linux images to memory address and then uses U-Boot to jump to that memory address.

This tutorial demonstrates assembling the binaries that are created using [Chapter 6, System Design Examples](#) in a boot image with all the security features enabled. This section also shows how PL bitstream can be added as a part of secure boot flow. Follow [Chapter 6, System Design Examples](#) till the section [Modifying the Build Settings](#) to create all the necessary files and then switch back.

Enabling the security features in boot image is done in two different methods. During the first method, the BIF file is manually created using a text editor and then using that BIF file to have Bootgen create keys. This enables you to identify the sections of the BIF file that are enabled which security features. The second method uses the Create Boot Image wizard in SDK. It demonstrates the same set of security features. The second method reuses the keys from the first method for convenience.

Generating Keys for Authentication

There are multiple methods of generating keys. These include, but are not limited to, using bootgen, customized key files, OpenSSL and Hardware Security Modules (HSMs). This tutorial covers methods using bootgen. The bootgen created files can be used as templates for creating files containing user-specified keys from the other key sources.

The creation of keys using bootgen commands requires the generation and modification of the BIF files. The key generation section of this tutorial creates these bif files "by hand" using a text editor. The next section, building your boot image demonstrates how to create these BIF files using the SDKs Bootgen GUI (create Boot Image Wizard).

Creating RSA Private/Public Key Pairs

For this example, you will create the Primary and Secondary keys in the PEM format. The keys are generated using Bootgen command-line options. Alternately, you can create the keys using external tools like OpenSSL.

The following steps describe the process of creating the RSA Private/Public Key Pairs:

1. Launch the shell for SDK.
2. Select **Xilinx > Launch Shell**.

3. Create a file named `key_generation.bif`.

Note: The `key_generation.bif` file will be used to create both the asymmetric keys in these steps and the symmetric keys in later steps.

```
the_ROM_image:
{
  [pskfile]psk0.pem
  [sskfile]ssk0.pem
  [auth_params]spk_id = 0; ppk_select = 0
  [fsbl_config]a53_x64
  [bootloader]fsbl_a53.elf
  [destination_cpu = pmu]pmu_fw.elf
  [destination_device = pl]edt_zcu102_wrapper.bit
  [destination_cpu = a53-0, exception_level = el-3, trustzone] bl31.elf
  [destination_cpu = r5-0]tmr_psled_r5.elf
  [destination_cpu = a53-0, exception_level = el-2]u-boot.elf
  [load = 0x1000000, destination_cpu = a53-0]image.ub
}
```

4. Save the `key_generation.bif` file in the `C:\edt\secure_boot_sd\keys` directory.
5. Copy all of the ELF, BIF and UB files built in [Chapter 6, System Design Examples](#) to `C:\edt\secure_boot_sd\keys` directory.
6. Navigate to the folder containing the BIF file.

```
cd C:\edt\secure_boot_sd\keys
```

7. Run the following command to generate the keys:

```
bootgen -p zu9eg -arch zynqmp -generate_keys auth pem -image key_generation.bif
```

8. Verify that the files `ppk0.pem` and `ssk0.pem` are generated at the location specified in the BIF file (`c:\edt\secure_boot_sd\keys`).

Generate SHA3 of Public Key in RSA Private/Public Key Pair

The following steps are required only for RSA Authentication with eFUSE mode, and can be skipped for RSA authentication with bootheader mode. The 384 bits from `sha3.txt` can be programmed to eFUSE for RSA Authentication with the eFUSE Mode. For more information, see *Programming BBRAM and eFUSES (XAPP1319)*[\[Ref 13\]](#).

1. Perform the steps from the prior section.
2. Now that the PEM files have been defined, add `authentication = rsa` attributes as shown below to `key_generation.bif`

```
the_ROM_image:
{
  [pskfile]psk0.pem
  [sskfile]ssk0.pem
  [auth_params]spk_id = 0; ppk_select = 0
  [fsbl_config]a53_x64
  [bootloader, authentication = rsa]fsbl_a53.elf
  [destination_cpu = pmu, authentication = rsa]pmu_fw.elf
}
```

```

[destination_device = pl, authentication = rsa]edt_zcu102_wrapper.bit
[destination_cpu = a53-0, exception_level = el-3, trustzone, authentication =
rsa]bl31.elf
[destination_cpu = r5-0, authentication = rsa]tmr_psled_r5.elf
[destination_cpu = a53-0, exception_level = el-2, authentication = rsa]u-boot.elf
[load = 0x1000000, destination_cpu = a53-0, authentication = rsa]image.ub
}
    
```

3. Use the bootgen command to calculate the hash of the PPK:

```

bootgen -p zcu9eg -arch zynqmp -efuseppkbits ppk0_digest.txt -image
key_generation.bif
    
```

4. Verify that the file `ppk0_digest.txt` is generated at the location specified (`c:\edt\secure_boot_sd\keys`).

Additional RSA Private/Public Key Pairs

The steps in this section to generate Secondary RSA Private/Public key pair required for Key Revocation, which requires programming of eFUSE. For more information, see *Programming BBRAM and eFUSES* (XAPP1319)[Ref 13]. You can skip this section if you do not intend to use Key Revocation.

Repeat steps from [Creating RSA Private/Public Key Pairs](#) and [Generate SHA3 of Public Key in RSA Private/Public Key Pair](#) to generate the second RSA private/public key pair and generate the SHA3 of the second PPK.

1. Perform the steps from the prior section but with replacing `psk0.pem`, `ssk0.pem`, and `ppk0_digest.txt` with `psk1.pem`, `ssk1.pem` and `ppk1_digest.pem` respectively. Save this file as `key_generation_1.bif`. That .bif file will look like:

```

the_ROM_image:
{
  [pskfile]psk1.pem
  [sskfile]ssk1.pem
  [auth_params]spk_id = 1; ppk_select = 1
  [fsbl_config]a53_x64
  [bootloader]fsbl_a53.elf
  [destination_cpu = pmu]pmu_fw.elf
  [destination_device = pl]edt_zcu102_wrapper.bit
  [destination_cpu = a53-0, exception_level = el-3, trustzone]bl31.elf
  [destination_cpu = r5-0]tmr_psled_r5.elf
  [destination_cpu = a53-0, exception_level = el-2]u-boot.elf
  [load = 0x1000000, destination_cpu = a53-0]image.ub
}
    
```

2. Run the bootgen command to create the RSA private/public key pairs.

```

bootgen -p zu9eg -arch zynqmp -generate_keys auth pem -image key_generation_1.bif
    
```

3. Add `authentication = rsa` attributes to the `key_generation_1.bif` file. The .bif file will look like:

```

the_ROM_image:
{
  [pskfile]psk1.pem
    
```

```

[sskfile]ssk1.pem
[auth_params]spk_id = 1; ppk_select = 1
[fsbl_config]a53_x64
[bootloader, authentication = rsa]fsbl_a53.elf
[destination_cpu = pmu, authentication = rsa]pmu_fw.elf
[destination_device = pl, authentication = rsa]edt_zcu102_wrapper.bit
[destination_cpu = a53-0, exception_level = el-3, trustzone, authentication =
rsa]bl31.elf
[destination_cpu = r5-0, authentication = rsa]tmr_psled_r5.elf
[destination_cpu = a53-0, exception_level = el-2, authentication = rsa]u-boot.elf
[load = 0x1000000, destination_cpu = a53-0, authentication = rsa]image.ub
}
    
```

4. Run the bootgen command to generate the hash of the primary RSA public key -

```

bootgen -p zcu9eg -arch zynqmp -efuseppkbits ppk1_digest.txt -image
key_generation_1.bif
    
```

5. Verify that the files `ppk1.pem`, `spk1.pem` and `ppk1_digest.txt` are all generated at the location specified (`c:\edt\secure_boot\keys`)

Enabling Boot Header Authentication

Boot header authentication is a mode of authentication that instructs the ROM to skip the checks of the eFUSE hashes for the PPKs, the revocation status of the PPKs and the Session IDs for the secondary keys. This mode is useful for testing and debugging as it does not require programming of eFUSES. This mode can be permanently disabled for a device by programming the RSA_EN eFUSES which forces RSA Authentication with the eFUSE checks. Fielded systems should use the RSA_EN eFUSE to force the eFUSE checks and disable Boot Header Authentication.

Add the `bh_auth_enable` attribute to the `[fsbl_config]` line so that the bif file appears as following:

```

the_ROM_image:
{
  [pskfile]psk0.pem
  [sskfile]ssk0.pem
  [auth_params]spk_id = 0; ppk_select = 0
  [fsbl_config]a53_x64, bh_auth_enable
  [bootloader, authentication = rsa]fsbl_a53.elf
  [destination_cpu = pmu, authentication = rsa]pmu_fw.elf
  [destination_device = pl, authentication = rsa]edt_zcu102_wrapper.bit
  [destination_cpu = a53-0, exception_level = el-3, trustzone, authentication =
rsa]bl31.elf
  [destination_cpu = r5-0, authentication = rsa]tmr_psled_r5.elf
  [destination_cpu = a53-0, exception_level = el-2, authentication = rsa]u-boot.elf
  [load = 0x1000000, destination_cpu = a53-0, authentication = rsa]image.ub
}
    
```

Generating Keys for Confidentiality

Image confidentiality is discussed in [Boot Image Confidentiality and DPA](#) section. In this section you will modify the `.bif` file from the authentication section by adding the attributes

required to enable image confidentiality, using the AES-256-GCM encryption algorithm. At the end, a bootgen command will be used to create all of the required AES-256 keys.

Using AES Encryption

1. Enable image confidentiality by specifying the key source for the initial encryption key (bbram_red_key for now) using the [keysrc_encryption] bbram_red_key attribute
2. On several of the partitions enable confidentiality by adding the encryption = aes attribute of the partitions. Also specify a unique key file for each partition. Having a unique key file for each partition allows each partition to use a unique set of keys which increases security strength by not reusing keys and reducing the amount of information encrypted on any one key. The key_generation.bif file should now look like -

```
the_ROM_image:
{
  [pskfile]psk0.pem
  [sskfile]ssk0.pem
  [auth_params]spk_id = 0; ppk_select = 0
  [keysrc_encryption]bbram_red_key
  [fsbl_config]a53_x64, bh_auth_enable
  [aeskeyfile]fsbl_a53.nky
  [bootloader, authentication = rsa, encryption = aes]fsbl_a53.elf
  [aeskeyfile]pmu_fw.nky
  [destination_cpu = pmu, authentication = rsa, encryption = aes]pmu_fw.elf
  [aeskeyfile]edt_zcu102_wrapper.nky
  [destination_device = pl, authentication = rsa, encryption =
aes]edt_zcu102_wrapper.bit
  [destination_cpu = a53-0, exception_level = el-3, trustzone, authentication =
rsa]bl31.elf
  [aeskeyfile]tmr_psled_r5.nky
  [destination_cpu = r5-0, authentication = rsa, encryption = aes]tmr_psled_r5.elf
  [destination_cpu = a53-0, exception_level = el-2, authentication = rsa]u-boot.elf
  [load = 0x1000000, destination_cpu = a53-0, authentication = rsa]image.ub
}
```

Enabling DPA Protections

This section provides the steps to use an operational key and key rolling effective countermeasures against the differential power analysis (DPA).

Enable use of an Operational Key

Use of an operational key limits the amount of information encrypted using the device key. Enable use of the operational key by adding the opt_key attribute to the [fsbl_config] line of the bif file. The key_generation.bif file should now look like as shown

```
the_ROM_image:
{
  [pskfile]psk0.pem
  [sskfile]ssk0.pem
  [auth_params]spk_id = 0; ppk_select = 0
```

```

[keysrc_encryption]bbram_red_key
[fsbl_config]a53_x64, bh_auth_enable, opt_key
[aeskeyfile]fsbl_a53.nky
[bootloader, authentication = rsa, encryption = aes]fsbl_a53.elf
[aeskeyfile]pmu_fw.nky
[destination_cpu = pmu, authentication = rsa, encryption = aes]pmu_fw.elf
[aeskeyfile]edt_zcu102_wrapper.nky
[destination_device = pl, authentication = rsa, encryption =
aes]edt_zcu102_wrapper.bit
[destination_cpu = a53-0, exception_level = el-3, trustzone, authentication =
rsa]bl31.elf
[aeskeyfile]tmr_psled_r5.nky
[destination_cpu = r5-0, authentication = rsa, encryption = aes]tmr_psled_r5.elf
[destination_cpu = a53-0, exception_level = el-2, authentication = rsa]u-boot.elf
[load = 0x1000000, destination_cpu = a53-0, authentication = rsa]image.ub
}

```

Enabling Encryption Using Key Rolling

Use of key rolling limits the amount of information encrypted using any of the other keys. Key-rolling is enabled on a partition-by-partition basis using the blocks attribute in the bif file. The blocks attribute allows specifying the amount of information in bytes to encrypt with each key. For example, blocks=4096,1024(3),512(*) would use the first key for 4096 bytes, the 2nd through 4th keys for 1024 bytes and all remaining keys for 512 bytes. In this example, the block command will be used to limit the life of each key to 1728 bytes.

Enable use of the key rolling by adding the blocks attribute to each of the encrypted partitions. The `key_generation.bif` file should now look like.

```

the_ROM_image:
{
  [pskfile]psk0.pem
  [sskfile]ssk0.pem
  [auth_params]spk_id = 0; ppk_select = 0
  [keysrc_encryption]bbram_red_key
  [fsbl_config]a53_x64, bh_auth_enable, opt_key
  [aeskeyfile]fsbl_a53.nky
  [bootloader, authentication = rsa, encryption = aes, blocks = 1728(*)]fsbl_a53.elf
  [aeskeyfile]pmu_fw.nky
  [destination_cpu = pmu, authentication = rsa, encryption = aes, blocks =
1728(*)]pmu_fw.elf
  [aeskeyfile]edt_zcu102_wrapper.nky
  [destination_device = pl, authentication = rsa, encryption = aes, blocks =
1728(*)]edt_zcu102_wrapper.bit
  [destination_cpu = a53-0, exception_level = el-3, trustzone, authentication =
rsa]bl31.elf
  [aeskeyfile]tmr_psled_r5.nky
  [destination_cpu = r5-0, authentication = rsa, encryption = aes, blocks =
1728(*)]tmr_psled_r5.elf
  [destination_cpu = a53-0, exception_level = el-2, authentication = rsa]u-boot.elf
  [load = 0x1000000, destination_cpu = a53-0, authentication = rsa]image.ub
}

```

Generating all of the AES keys

Once all of the desired encryption features have been enabled, all of the key files can be generated by running `bootgen`. Some of the source files (for example, ELF) contain multiple sections. These individual sections will be mapped to separate partitions, and each partition will have a unique key file. In this case, the key file will be appended with a ".1.". For example, if the `pmu_fw.elf` file contains multiple sections, both a `pmu_fw.nky` and a `pmu_fw.1.nky` file will be generated.

1. Create all of the necessary NKY files by running the `bootgen` command that creates the final `BOOT.bin` image.

```
bootgen -p zcu9eg -arch zynqmp -image key_generation.bif
```

2. Verify that the NKY files were generated. These file should include `edt_zcu102_wrapper.nky`, `fsbl_a53.nky`, `pmu_fw.nky`, `pmu_fw.1.nky`, `tmr_psled_r5.nky` and `tmr_psled_r5.1.nky`.

Using Key Revocation

Key revocation allows you to revoke a RSA primary or secondary public key. Key revocation may be used due to elapsed time of key use or if there is an indication that the key is compromised. The primary and secondary key revocation is controlled by onetime programmable eFUSES. The Xilinx Secure Key Library is used for key revocation, allowing key revocation in fielded devices. Key revocation is discussed further in *Zynq UltraScale+ MPSoC Technical Reference Manual* (UG1085) [Ref 5].

Using the PUF

In this section, the PUF is used for black key storage in the PUF Bootheader mode. RSA authentication is required when the PUF is used. In PUF Bootheader mode, the PUF helper data and the encrypted user's AES key are stored in the Bootheader. This section shows how to create a BIF for using the PUF. Because the helper data and encrypted user key will be unique for each and every board, the `bootgen` image created will only work on the board from which the helper data originated.

At the end of the [Secure Boot Sequence](#) section, a different BIF file demonstrates using the PUF in eFUSE mode. In PUF eFUSE mode, the PUF helper data and encrypted user's AES key are stored in eFUSES. In PUF eFUSE mode, a single boot image can be used across all boards.

PUF Registration - Boot Header Mode

The PUF registration software is included in the XILSKEY library. The PUF registration software operates in a Bootheader mode or eFUSE mode. The Bootheader mode allows development without programming the OTP eFUSES. The eFUSE mode is used in

production. This lab runs through PUF registration in Bootheader Mode only. For PUF registration using eFUSE, see *Programming BBRAM and eFUSES (XAPP1319)* [Ref 13].

The PUF registration software accepts a red (unencrypted) key as input, and produces syndrome data (helper data), which also contains CHASH and AUX, and a black (encrypted) key. When the PUF Bootheader mode is used, the output is put in the bootheader. When the PUF eFUSE mode is used, the output is programmed into eFUSES.

1. In SDK, right click **tmr_psled_r5_bsp** and click **Board Support Package Settings**
2. Ensure that xilskey and the xilsecure libraries are enabled.

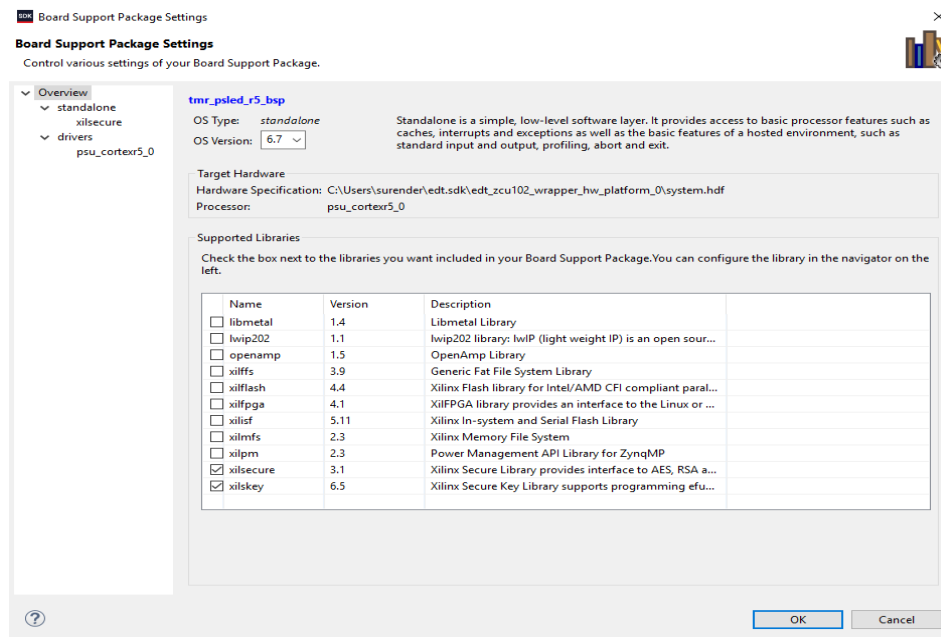

Figure 5-34: Select Xilskey and Xilsecure Libraries

3. Click **OK**. Now open **tmr_psled_r5_bsp > system.mss**.
4. Scroll to the Libraries section. Double click on **xilskey 6.5 Import Examples**.
5. In the dialog box, select the **xilskey_puf_registration** example. Click **OK**.

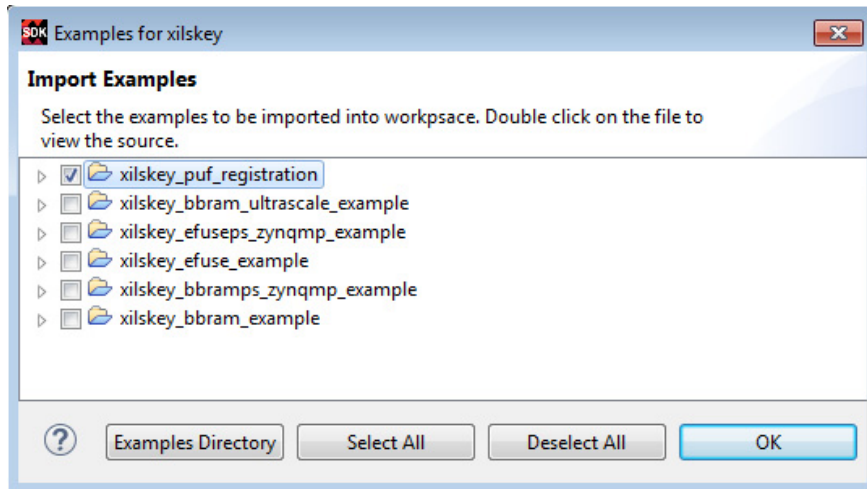

Figure 5-35: Import PUF Registration Example

6. In Project Explorer, right click **tmr_psled_r_bsp_xilskey_puf_registration_1**. Click **Rename** and rename to **puf_registration** and click **OK**.

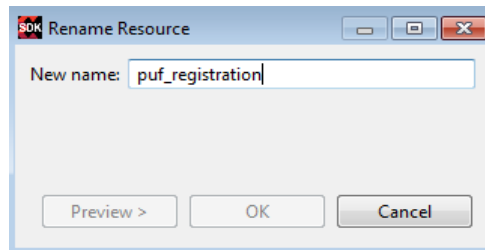

Figure 5-36: Rename PUF Registration Project

7. In Project Explorer, Puf_registration App ' Src ' double click `xilskey_puf_registration.h` to open in SDK.
8. Edit `xilskey_puf_registration.h` as follows:
 - a. Change `#define XSK_PUF_INFO_ON_UART` from `FALSE` to `TRUE`
 - b. Ensure that `#define XSK_PUF_PROGRAM_EFUSE` is set to `FALSE`
 - c. Set `XSK_PUF_AES_KEY` (the 256 bit key).

The key is to be entered in HEX format and should be `Key 0` from the `fsb1_a53.nky` file that you generated in [Generating all of the AES keys](#). You can find a sample key below:

```
#define XSK_PUF_AES_KEY
"68D58595279ED1481C674383583C1D98DA816202A57E7FE4F67859CB069CD510"
```

Note: Do not copy this key. Refer to the `fsb1_a53.nky` file for your key.

- d. Set the `XSK_PUF_IV`. The initialization vector IV is a 12 byte data of user choice.

```
#define XSK_PUF_IV "E1757A6E6DD1CC9F733BED31"
```

- In the src directory, double-click `lscript.ld` to open the linker script for this project. In the linker script change the application Memory Regions (except the vectors section) to `psu_r5_ddr_0_MEM_3` which has below base address and size:

```
base 0x7F000000
size 0xF00000
```

```

149
150 #define XSK_PUF_INFO_ON_UART TRUE
151 #define XSK_PUF_PROGRAM_EFUSE FALSE
152 #define XSK_PUF_IF_CONTRACT_MANUFATURER FALSE
153
154 /* For programming/reading secure bits of PUF */
155 #define XSK_PUF_READ_SECUREBITS FALSE
156 #define XSK_PUF_PROGRAM_SECUREBITS FALSE
157
158 #if (XSK_PUF_PROGRAM_SECUREBITS == TRUE)
159 #define XSK_PUF_SYN_INVALID FALSE
160 #define XSK_PUF_SYN_WRLK FALSE
161 #define XSK_PUF_REGISTER_DISABLE FALSE
162 #define XSK_PUF_RESERVED FALSE
163 #endif
164
165 #define XSK_PUF_AES_KEY "CA4079947071A044D1179111DE1BD6274CAE61A3D9D0490A6928BA69E4DCD5A0"
166 #define XSK_PUF_IV "945435B80C7CA66A912BDB68"
167

```

Figure 5-37: PUF Registration in Bootheader Mode

- Save the file and exit.
- In Project Explorer, right click on the **puf_registration** project and select **Build Project**
- In SDK, select **Xilinx > Create Boot Image**.
- Select Zynq MP in the Architecture dialog box.
- In the Output BIF file path: dialog box, specify

```
C:\edt\secureboot_sd\puf_registration\puf_registration.bif
```

- In the Output Path dialog box, specify

```
C:\edt\secureboot_sd\puf_registration\BOOT.bin
```

- In the Boot Image Partitions pane, click **Add**. Add the partitions and set the destination CPU of the puf_registration application to R5-0:

```
C:\edt\edt_zcu102\edt_zcu102.sdk\fsbl_a53\Debug\fsbl_a53.elf
C:\edt\edt_zcu102\edt_zcu102.sdk\puf_registration\Debug\puf_registration.elf
```

- Click on **Create Image** to create the Boot Image for PUF registration

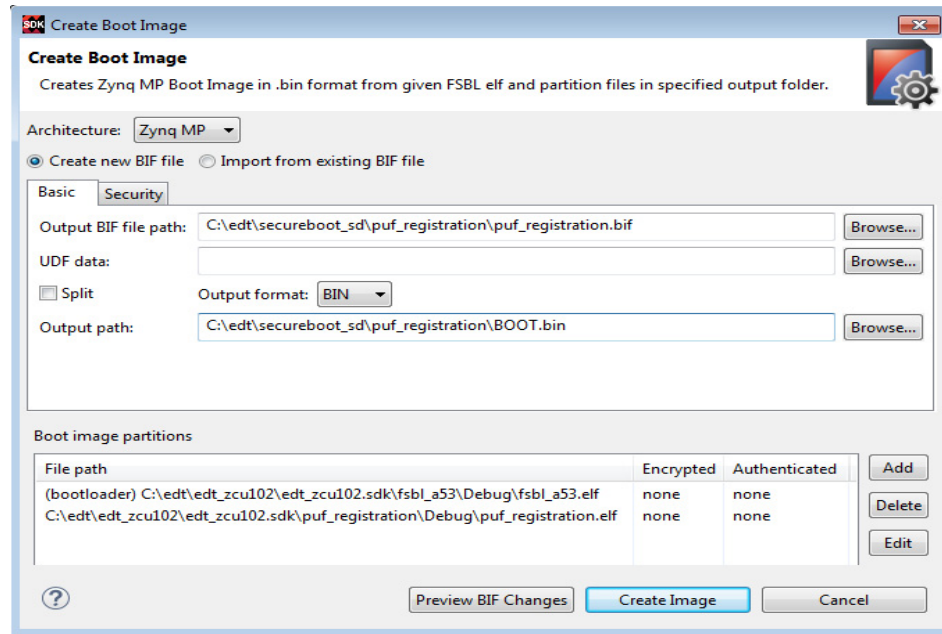

Figure 5-38: PUF Registration Software

18. Insert a SD card into the PC SD card slot.
19. Copy `C:\edt\secureboot_sd\puf_registration\BOOT.bin` to the SD Card
20. Move the SD card from the PC SD card slot to the ZCU102 card slot.
21. Start a terminal session, using Tera Term or Minicom depending on the host machine being used, as well as the COM port and baud rate for your system, as shown in [Figure 3-12](#).
22. In the communication terminal menu bar, select **File > Log**. Enter `C:\edt\secureboot_sd\puf_registration\puf_registration.log` in the dialog box.
23. Power cycle the board.
24. After the `puf_registration` software has run, exit the communication terminal.
25. The `puf_registration.log` content is used in [Using PUF in Bootheader Mode](#). Open `puf_registration.log` in a text editor.
26. Save the PUF Syndrome data that starts after App PUF Syndrome data Start!!!; and ends at PUF Syndrome data End!!!, non-inclusive, to a file named `helperdata.txt`.
27. Save the black key IV identified by App: Black Key IV - to a file named `black_iv.txt`.
28. Save the black key to a file named `black_key.txt`.
29. The files `helperdata.txt`, `black_key.txt`, and `black_iv.txt` can be saved in `C:\edt\secure_boot_sd\keys`

Using PUF in Bootheader Mode

The following steps describes the process to update the .bif file from the previous sections to include using the PUF in Boot Header mode. This section will make use of the Syndrome data and Black Key created during PUF registration process.

1. Enable use of the PUF by adding all of the fields and attributes indicated in bold to the bif file (key_generation.bif) shown below.

```
the_ROM_image:
{
  [pskfile]psk0.pem
  [sskfile]ssk0.pem
  [auth_params]spk_id = 0; ppk_select = 0
  [keysrc_encryption]bh_blk_key
  [bh_key_iv]black_iv.txt
  [bh_keyfile]black_key.txt
  [puf_file]helperdata.txt
  [fsbl_config]a53_x64, bh_auth_enable, opt_key, puf4kmode, shutter=0x0100005E,
  pufhd_bh
  [aeskeyfile]fsbl_a53.nky
  [bootloader, authentication = rsa, encryption = aes, blocks = 1728(*)]fsbl_a53.elf
  [aeskeyfile]pmu_fw.nky
  [destination_cpu = pmu, authentication = rsa, encryption = aes, blocks =
  1728(*)]pmu_fw.elf
  [aeskeyfile]edt_zcu102_wrapper.nky
  [destination_device = pl, authentication = rsa, encryption = aes, blocks =
  1728(*)]edt_zcu102_wrapper.bit
  [destination_cpu = a53-0, exception_level = el-3, trustzone, authentication =
  rsa]bl31.elf
  [aeskeyfile]tmr_psled_r5.nky
  [destination_cpu = r5-0, authentication = rsa, encryption = aes, blocks =
  1728(*)]tmr_psled_r5.elf
  [destination_cpu = a53-0, exception_level = el-2, authentication = rsa]u-boot.elf
  [load = 0x1000000, destination_cpu = a53-0, authentication = rsa]image.ub
}
```

2. The above .bif file can be used for creating a final boot image using an AES key encrypted in the boot image header with the PUF KEK. This would be done using the following bootgen command.

```
bootgen -p zcu9eg -arch zynqmp -image key_generation.bif -w -o BOOT.bin
```

Note: The above steps can also be executed with PUF in eFUSE mode. In this case you can repeat the previous steps, using the PUF in eFUSE mode. This requires enabling the programming of eFUSES during PUF registration by setting the XSK_PUF_PROGRAM_EFUSE macro in the xilskey_puf_registration.h file used to build the PUF registration application. Also, the BIF would need to be modified to use the encryption key from eFUSE and removing the helper data and black key files. PUF in eFUSE mode is not covered in this tutorial in order to avoid programming the eFUSES on development or tutorial systems.

```
[keysrc_encryption]efuse_blk_key
[bh_key_iv]black_iv.txt
```

System Example Using the SDK Create Boot Image Wizard

The prior sections enabled the various security features (authentication, confidentiality, DPA protections, and black key storage) by hand editing the BIF file. This section performs the same operations, but uses the SDK Bootgen Wizard as a starting point. The SDK Bootgen Wizard creates a base BIF file, and then adds the additional security features that are not supported by the wizard using a text editor.

1. Change directory to the `bootgen_lab_files` directory.

```
cd C:\edt\secure_boot_sd\bootgen_files
```

2. Copy the below data from the prior example to this example.

```
cp ../keys/*nky .
cp ../Keys/*pem .
cp ../keys/black_iv.txt .
cp ../keys/helper_data.txt .
cp ../keys/*.elf .
cp ../keys/edt_zcu102_wrapper.bit .
cp ../keys/image.ub .
```

3. Click **Programs** > **Xilinx Design Tools** > **SDK 2018.2** > **Xilinx SDK 2018.2** to launch SDK.
4. Click **Xilinx Tools** > **Create Boot Image** from the SDK menu bar to launch the Create Boot Image wizard.
5. Select **Zynq MP** as the Architecture.
6. Enter the Output BIF file path as
`c:\edt\secure_boot_sd\bootgen_files\design_bh_bkey_keyrolling.bif`.
7. Select BIN as the output format.
8. Enter the output path `c:\edt\secure_boot_sd\bootgen_files\BOOT.bin`
9. Enable authentication.
 - a. Click the **Security** tab.
 - b. Check the **Use Authentication** check box.
 - c. Browse to select the `psk0.pem` file for the PSK and the `ssk0.pem` for the SSK.
 - d. Ensure PPK select is 0.
 - e. Enter SPK ID as 0.
 - f. Check the Use BH Auth checkbox.

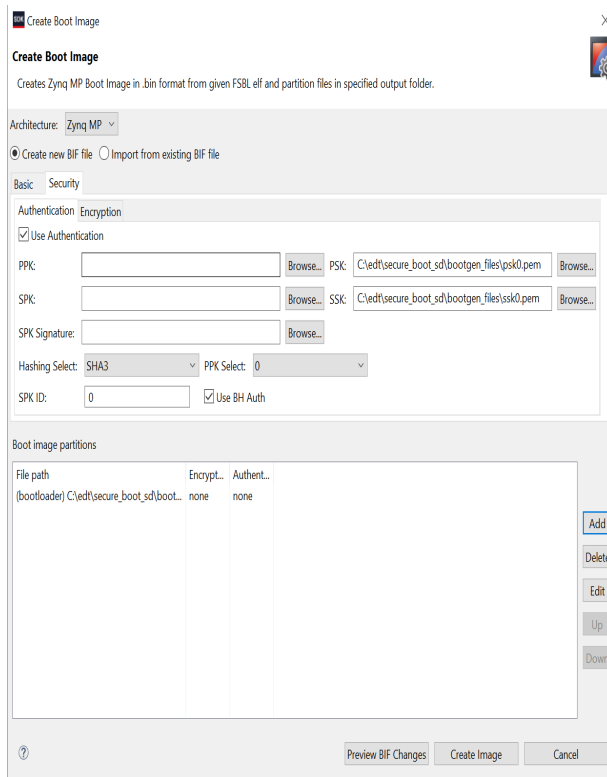

Figure 5-39: Enable Authentication

10. Enable encryption.

- a. Click the **Encryption** tab.
- b. Check the **Use Encryption** checkbox.
- c. Use the browse button to select `fsbl_a53.nky` as the key file.
- d. Check the **Operational Key** checkbox.

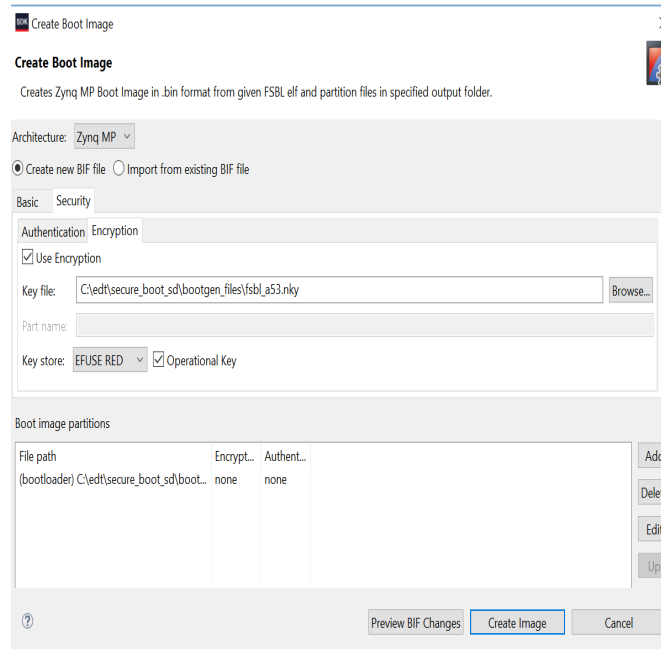

Figure 5-40: Enable Encryption

11. Click the **Basic** tab.
12. Add the FSBL binary to the boot image.
 - a. Click **Add**.
 - b. Use the browse button to select the `fsbl_a53.elf` file.
 - c. Make sure the partition-type is boot loader and the destination CPU is a53x64.
 - d. Change authentication to RSA.
 - e. Change encryption to AES.
 - f. Click **OK**.

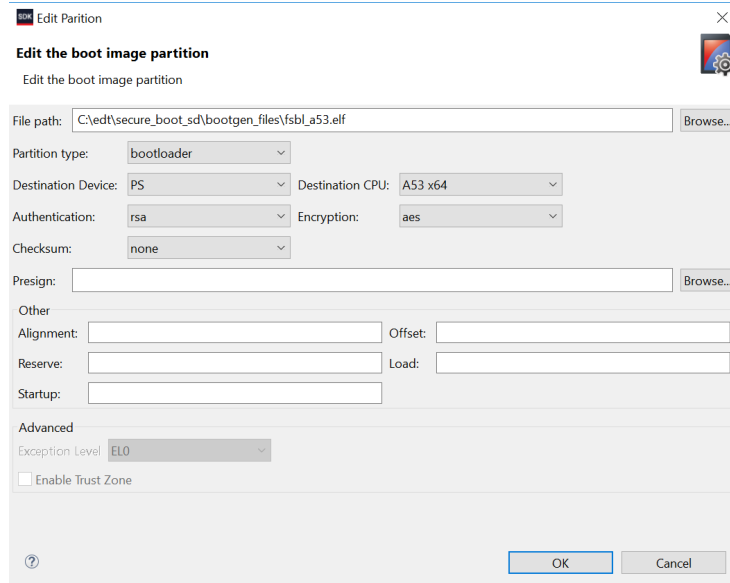

Figure 5-41: Adding FSBL Binary

13. Add the PMW firmware binary to the boot image.
 - a. Click **Add**.
 - b. Use the browse button to select the `pmu_fw.elf` file.
 - c. Make sure the partition-type is datafile.
 - d. Change the destination CPU to PMU.
 - e. Change authentication to RSA.
 - f. Change encryption to AES.
 - g. Click **OK**.

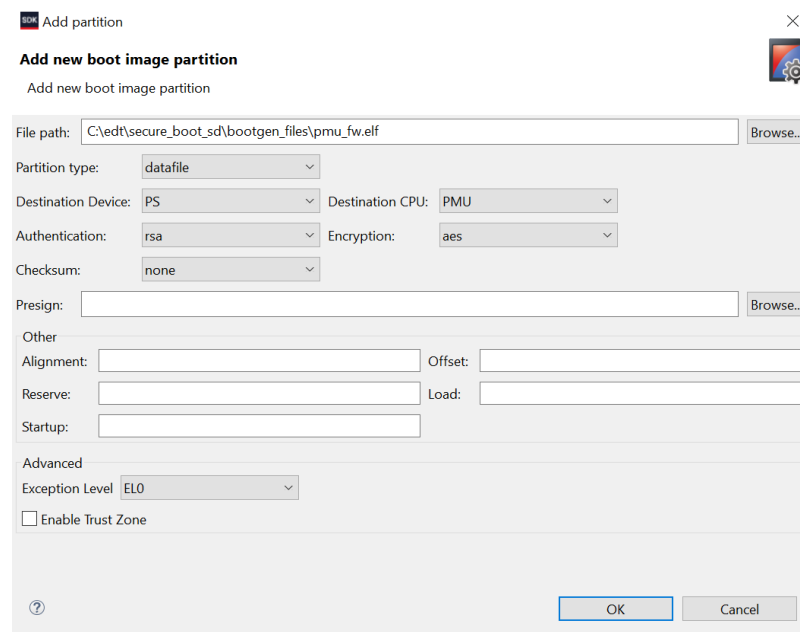

Figure 5-42: Adding PMU Firmware Binary

14. Add the PL Bitstream to the boot image.
 - a. Click the **Add**.
 - b. Use the browse button to select the `edt_zcu102_wrapper.bit` file.
 - c. Make sure the partition-type is datafile.
 - d. Make sure the destination device is PL.
 - e. Change authentication to RSA.
 - f. Change encryption to AES.
 - g. Click **OK**.

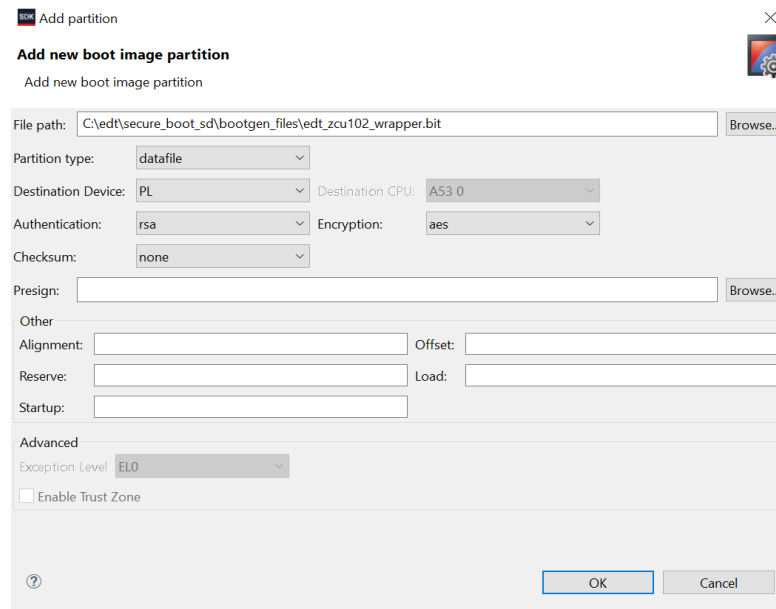

Figure 5-43: Adding PL Bitstream

15. Add the Arm Trusted Firmware (ATF) binary to the image.
 - a. Click **Add**.
 - b. Use the browse button to select the `b131.elf` file.
 - c. Make sure the partition-type is datafile.
 - d. Make sure the destination CPU is A53 0.
 - e. Change authentication to RSA.
 - f. Make sure the encryption is none.
 - g. Make sure the Exception Level is EL3.
 - h. Click **OK**.

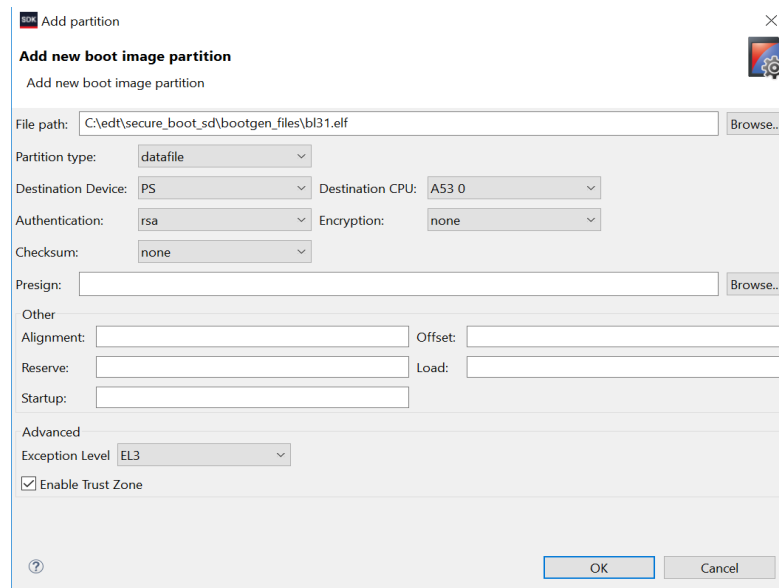

Figure 5-44: Adding Arm Trusted Firmware

16. Add the R5 software binary to the boot image.

- a. Click **Add**.
- b. Use the browse button to select the `tmr_psled_r5.elf` file.
- c. Make sure the partition-type is datafile.
- d. Make sure the destination CPU is R5 0.
- e. Change authentication to RSA.
- f. Change encryption to AES.
- g. Click **OK**.

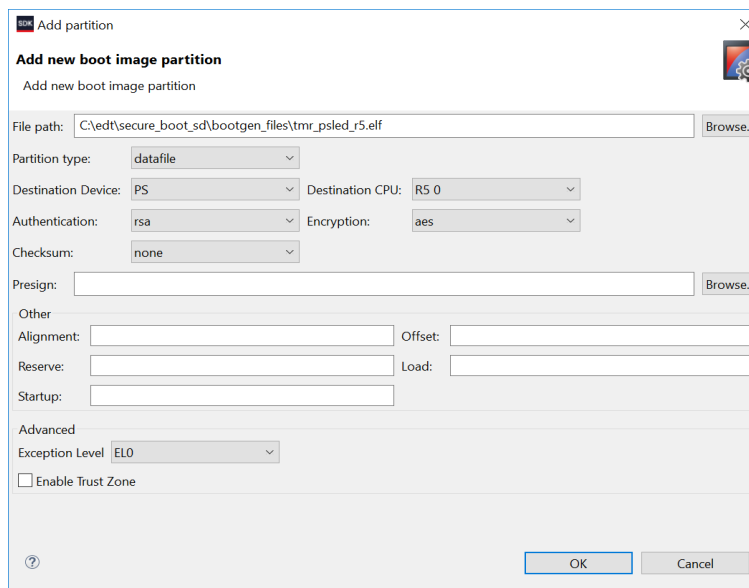

Figure 5-45: Adding R5 Application Binary

17. Add the U-Boot software binary to the boot image.
 - a. Click **Add**.
 - b. Use the browse button to select the `u-boot.elf` file.
 - c. Make sure the partition-type is `datafile`.
 - d. Make sure the destination CPU is `A53 0`.
 - e. Change authentication to `RSA`.
 - f. Make sure that encryption is `none`.
 - g. Change the Exception Level to `EL2`.
 - h. Click **OK**.

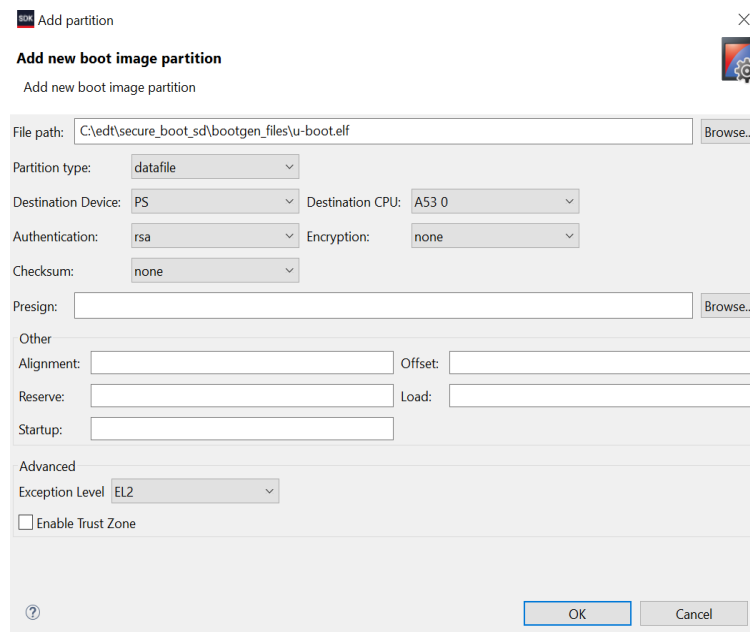

Figure 5-46: Adding U-Boot Software

18. Add the Linux image to the boot image.
 - a. Click **Add**.
 - b. Use the browse button to select the `image.ub` file.
 - c. Make sure the partition-type is datafile.
 - d. Make sure the destination CPU is A53 0.
 - e. Change authentication to RSA.
 - f. Make sure that encryption is none.
 - g. Update the load field to 0x1000000.
 - h. Click **OK**.

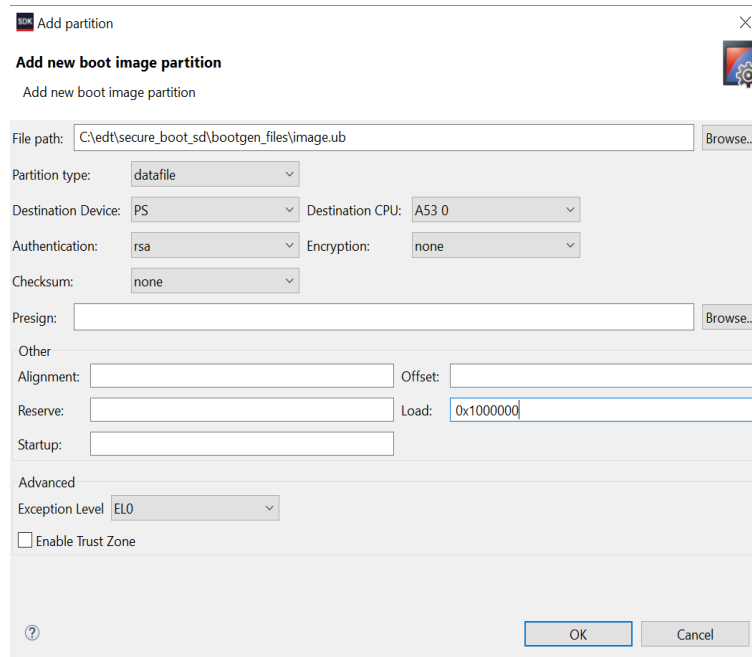

Figure 5-47: Adding Linux Boot Image

19. Click **Create image**

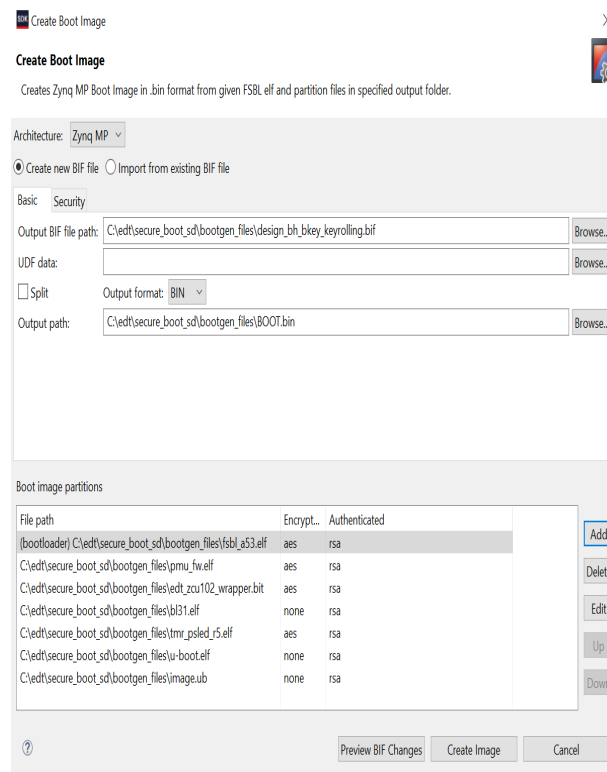

Figure 5-48: Creating a Final Boot Image

20. The `design_bh_bkey_keyrolling.bif` file should look similar to the following:

```
the_ROM_image:
{
  [pskfile]psk0.pem
  [sskfile]ssk0.pem
  [auth_params]spk_id = 0; ppk_select = 0
  [aeskeyfile]fsbl_a53.nky
  [keysrc_encryption]efuse_red_key
  [fsbl_config]a53_x64, bh_auth_enable, opt_key
  [bootloader, encryption = aes, authentication = rsa]fsbl_a53.elf
  [encryption = aes, authentication = rsa, destination_cpu = pmu]pmu_fw.elf
  [encryption = aes, authentication = rsa, destination_device =
pl]edt_zcu102_wrapper.bit
  [authentication = rsa, destination_cpu = a53-0, exception_level = e1-3]bl31.elf
  [encryption = aes, authentication = rsa, destination_cpu = r5-0]tmr_psled_r5.elf
  [authentication = rsa, destination_cpu = a53-0, exception_level = e1-2]u-boot.elf
  [authentication = rsa, load = 0x1000000, destination_cpu = a53-0]image.ub
}
```

21. This BIF file is still missing several security features that are not supported by the Create Boot Image wizard. These are features are per-partition nky files, key rolling and black key store.

22. Add black key store by changing the `keysrc_encryption` and adding the other additional items so that the BIF file looks like the following:

```
the_ROM_image:
{
  [pskfile]psk0.pem
  [sskfile]ssk0.pem
  [auth_params]spk_id = 0; ppk_select = 0
  [aeskeyfile]fsbl_a53.nky
  [keysrc_encryption]bh_blk_key
  [bh_key_iv]black_iv.txt
  [bh_keyfile]black_key.txt
  [puf_file]helperdata.txt
  [fsbl_config]a53_x64, bh_auth_enable, opt_key, puf4kmode, shutter=0x0100005E,
pufhd_bh
  [bootloader, encryption = aes, authentication = rsa]fsbl_a53.elf
  [encryption = aes, authentication = rsa, destination_cpu = pmu]pmu_fw.elf
  [encryption = aes, authentication = rsa, destination_device =
pl]edt_zcu102_wrapper.bit
  [authentication = rsa, destination_cpu = a53-0, exception_level = e1-3]bl31.elf
  [encryption = aes, authentication = rsa, destination_cpu = r5-0]tmr_psled_r5.elf
  [authentication = rsa, destination_cpu = a53-0, exception_level = e1-2]u-boot.elf
  [authentication = rsa, load = 0x1000000, destination_cpu = a53-0]image.ub
}
```

23. Specify unique AES key files for each encrypted partition by updating the BIF file to look like the following:

```
the_ROM_image:
{
  [pskfile]psk0.pem
  [sskfile]ssk0.pem
  [auth_params]spk_id = 0; ppk_select = 0
  [aeskeyfile]fsbl_a53.nky
  [keysrc_encryption]bh_blk_key
```

```

[bh_key_iv]black_iv.txt
[bh_keyfile]black_key.txt
[puf_file]helperdata.txt
[fsbl_config]a53_x64, bh_auth_enable, opt_key, puf4kmode, shutter=0x0100005E,
pufhd_bh
[bootloader, encryption = aes, authentication = rsa]fsbl_a53.elf
[aeskeyfile]pmu_fw.nky
[encryption = aes, authentication = rsa, destination_cpu = pmu]pmu_fw.elf
[aeskeyfile]edt_zcu102_wrapper.nky
[encryption = aes, authentication = rsa, destination_device =
pl]edt_zcu102_wrapper.bit
[authentication = rsa, destination_cpu = a53-0, exception_level = e1-3]bl31.elf
[aeskeyfile]tmr_psled_r5.nky
[encryption = aes, authentication = rsa, destination_cpu = r5-0]tmr_psled_r5.elf
[authentication = rsa, destination_cpu = a53-0, exception_level = e1-2]u-boot.elf
[authentication = rsa, load = 0x1000000, destination_cpu = a53-0]image.ub
}
    
```

24. Enable key rolling by adding the block attributes to the encrypted partitions. The updated BIF file should now look like the following:

```

the_ROM_image:
{
  [pskfile]psk0.pem
  [sskfile]ssk0.pem
  [auth_params]spk_id = 0; ppk_select = 0
  [aeskeyfile]fsbl_a53.nky
  [keysrc_encryption]bh_blk_key
  [bh_key_iv]black_iv.txt
  [bh_keyfile]black_key.txt
  [puf_file]helperdata.txt
  [fsbl_config]a53_x64, bh_auth_enable, opt_key, puf4kmode, shutter=0x0100005e,
  pufhd_bh
  [bootloader, encryption = aes, authentication = rsa, blocks = 1728(*)]fsbl_a53.elf
  [aeskeyfile]pmu_fw.nky
  [encryption = aes, authentication = rsa, destination_cpu = pmu, blocks =
  1728(*)]pmu_fw.elf
  [aeskeyfile]edt_zcu102_wrapper.nky
  [encryption = aes, authentication = rsa, destination_device = pl, blocks =
  1728(*)]edt_zcu102_wrapper.bit
  [authentication = rsa, destination_cpu = a53-0, exception_level = e1-3]bl31.elf
  [aeskeyfile]tmr_psled_r5.nky
  [encryption = aes, authentication = rsa, destination_cpu = r5-0, blocks =
  1728(*)]tmr_psled_r5.elf
  [authentication = rsa, destination_cpu = a53-0, exception_level = e1-2]u-boot.elf
  [authentication = rsa, load = 0x1000000, destination_cpu = a53-0]image.ub
}
    
```

25. Generate the boot image by running the following command. Note that the `-encryption_dump` flag has been added. This flag causes the log file `aes_log.txt` to be created. The log file details all encryption operations that were used. This allows you to see which keys and IVs were used on which sections of the boot image.

```

bootgen -p zcu9eg -arch zynqmp -image design_bh_bkey_keyrolling.bif -w -o BOOT.bin
-encryption_dump
    
```

Booting the system using a Secure Boot Image

This section demonstrates how to use the `BOOT.bin` boot image created in prior sections to perform a secure boot using the ZCU102.

1. Copy the `BOOT.bin` image and the `ps_pl_linux_app.elf` over to the SD card from `c:\edt\secure_boot_sd\bootgen_files`.
2. Insert the SD card into the ZCU102.
3. Set SW6 of the ZCU102 for SD boot mode (1=ON; 2,3,4=OFF).

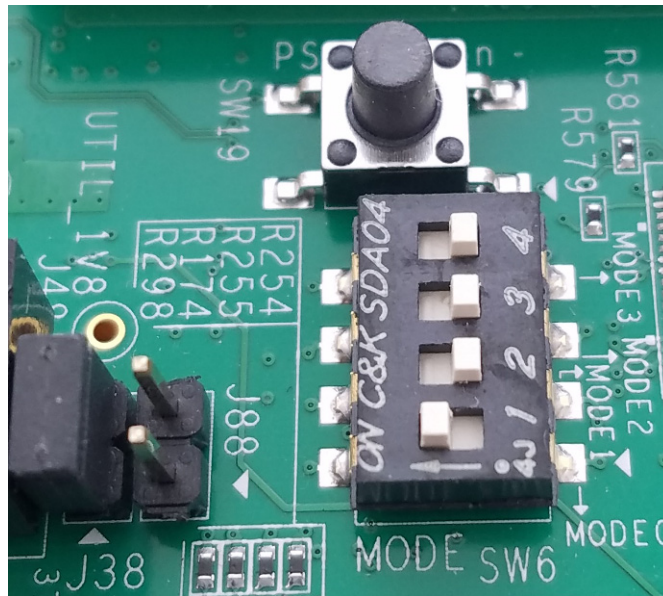

Figure 5-49: SW6 Switch Settings for SD boot Mode

4. Connect Serial terminals to ZCU102 (115200, 8 data bits, 1 stop bit, no parity)
5. Power on the ZCU102
6. When the terminal reaches the u-boot ZynqMP> prompt, type `bootm 0x1000000`.

```
Rd Block Len: 512
SD version 3.0
High Capacity: Yes
Capacity: 3.7 GiB
Bus Width: 4-bit
Erase Group Size: 512 Bytes
reading image.ub
** Unable to read file image.ub **
ZynqMP> bootm 0x1000000
```

Figure 5-50: U-Boot Prompt

7. Login into Linux using the following credentials:

Login: root;

password: root

```
PetaLinux 2017.1 plnx_aarch64 /dev/ttyPS0
plnx_aarch64 login: root
Password: 
```

Figure 5-51: Linux Login

Run the Linux Application as described in [Design Example 1: Using GPIOs, Timers, and Interrupts](#).

Running the Linux Application

Use the following steps to run a Linux application:

1. Copy the application from SD card mount point to /tmp.

```
# cp /run/media/mmcblk0p1/ps_pl_linux_app.elf /tmp
```

Note: Mount the SD card manually if you fail to find SD card contents in this location.

```
# mount /dev/mmcblk0p1 /media/
```

2. Copy the application to /tmp.

```
# cp /media/ps_pl_linux_app.elf /tmp
```

3. Run the application.

```
# /tmp/ps_pl_linux_app.elf
```

Sample BIF for a fielded system

The following BIF file is an example for a fielded system. In order for this bif file to work on a board it requires the RSA_EN, PPK0 Digest, black AES key and PUF helper data to all be programmed in the eFUSES. Since programming these eFUSES severely limits the use of the device or board for testing and debugging, it is only included here as a reference. It is not part of the tutorial.

The following changes are made to the final `generation.bif` file reach the following result:

1. Change from PUF Bootheader mode to PUF eFUSE mode.
 - a. Change the `keysrc_encryption` attribute to `efuse_blk_key`.
 - b. Remove the `bh_keyfile` and `puf_file` lines.
 - c. Remove the `puf4kmode` and `pufhd_bh` attributes from the `fsbl_config` line.
2. Change from boot header authentication to eFUSE authentication.
 - a. Remove the `bh_auth_enable` attribute from the `fsbl_config` line.

```

the_ROM_image:
{
  [pskfile]psk0.pem
  [sskfile]ssk0.pem
  [auth_params]spk_id = 0; ppk_select = 0
  [keysrc_encryption]efuse_blk_key
  [bh_key_iv]black_iv.txt
  [fsbl_config]a53_x64, opt_key, shutter=0x0100005E
  [aeskeyfile]fsbl_a53.nky
  [bootloader, authentication = rsa, encryption = aes, blocks = 1728(*)]fsbl_a53.elf
  [aeskeyfile]pmu_fw.nky
  [destination_cpu = pmu, authentication = rsa, encryption = aes, blocks =
  1728(*)]pmu_fw.elf
  [aeskeyfile]edt_zcu102_wrapper.nky
  [destination_device = pl, authentication = rsa, encryption = aes, blocks =
  1728(*)]edt_zcu102_wrapper.bit
  [destination_cpu = a53-0, exception_level = el-3, trustzone, authentication =
  rsa]bl31.elf
  [aeskeyfile]tmr_psled_r5.nky
  [destination_cpu = r5-0, authentication = rsa, encryption = aes, blocks =
  1728(*)]tmr_psled_r5.elf
  [destination_cpu = a53-0, exception_level = el-2, authentication = rsa]u-boot.elf
  [load = 0x1000000, destination_cpu = a53-0, authentication = rsa]image.ub
}
    
```

System Design Examples

This chapter guides you through building a system based on Zynq® UltraScale+™ devices using available tools and supported software blocks. This chapter highlights how you can use the software blocks you configured in [Chapter 3](#) to create a Zynq UltraScale+ system. It does not discuss domain-specific designs, but rather highlights different ways to use low-level software available for Zynq UltraScale+ devices.

Design Example 1: Using GPIOs, Timers, and Interrupts

The Zynq ZCU102 UltraScale+ Evaluation Board comes with a few user configurable Switches and LEDs. This design example makes use of bare-metal and Linux applications to toggle these LEDs, with the following details:

- The Linux applications configure a set of PL LEDs to toggle using a PS Dip Switch, and another set of PL LEDs to toggle using a PL Dip Switch (SW17).
- The Linux APU A-53 Core 0 hosts this Linux application, while the RPU R5-0 hosts another bare-metal application.
- The R5-Core 0 application uses an AXI Timer IP in Programmable logic to toggle PS LED (DS50). The application is configured to toggle the LED state every time the timer counter expires, and the Timer in the PL is set to reset periodically after a user-configurable time interval. The system is configured such that the APU Linux Application and RPU Bare-metal Application run simultaneously.

Configuring Hardware

The first step in this design is to configure the PS and PL sections. This can be done in Vivado IP integrator. You start with adding the required IPs from the Vivado IP catalog and then connect the components to blocks in the PS subsystem.

1. If the Vivado Design Suite is already open, start from the block diagram (shown in [Figure 2-2](#)) and jump to [step 4](#).
2. Open the Vivado Project that you created:

```
C:/edt/edt_zcu102/edt_zcu102.xpr
```

3. In the Flow Navigator, under **IP Integrator**, click **Open Block Design** and select **edt_zcu102.bd**.

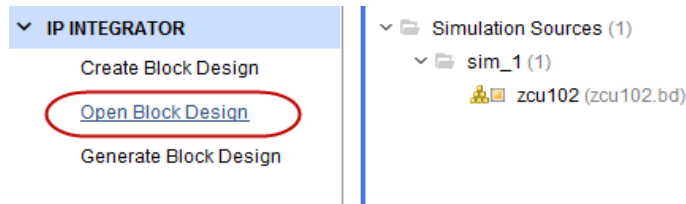

Figure 6-1: Open Block Design

4. Right click in the block diagram and select **Add IP** from the IP catalog.

Adding and Configuring IPs

1. In the catalog, select **AXI Timer**.

The IP Details information displays, as shown in the following figure.

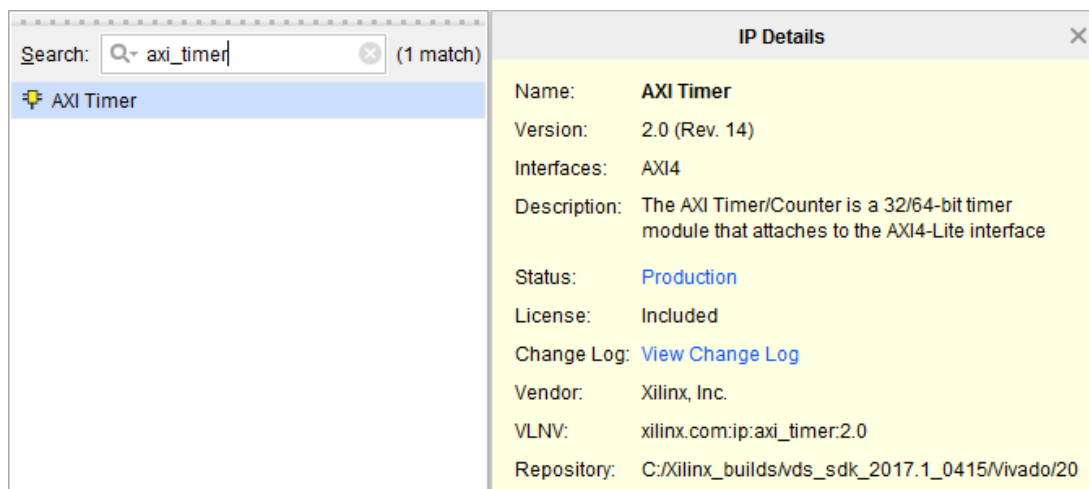

Figure 6-2: IP Details Information

2. Double-click the **AXI Timer** IP to add it to the design.

3. Double-click the **AXI Timer** IP again to configure the IP, as shown in following figure.

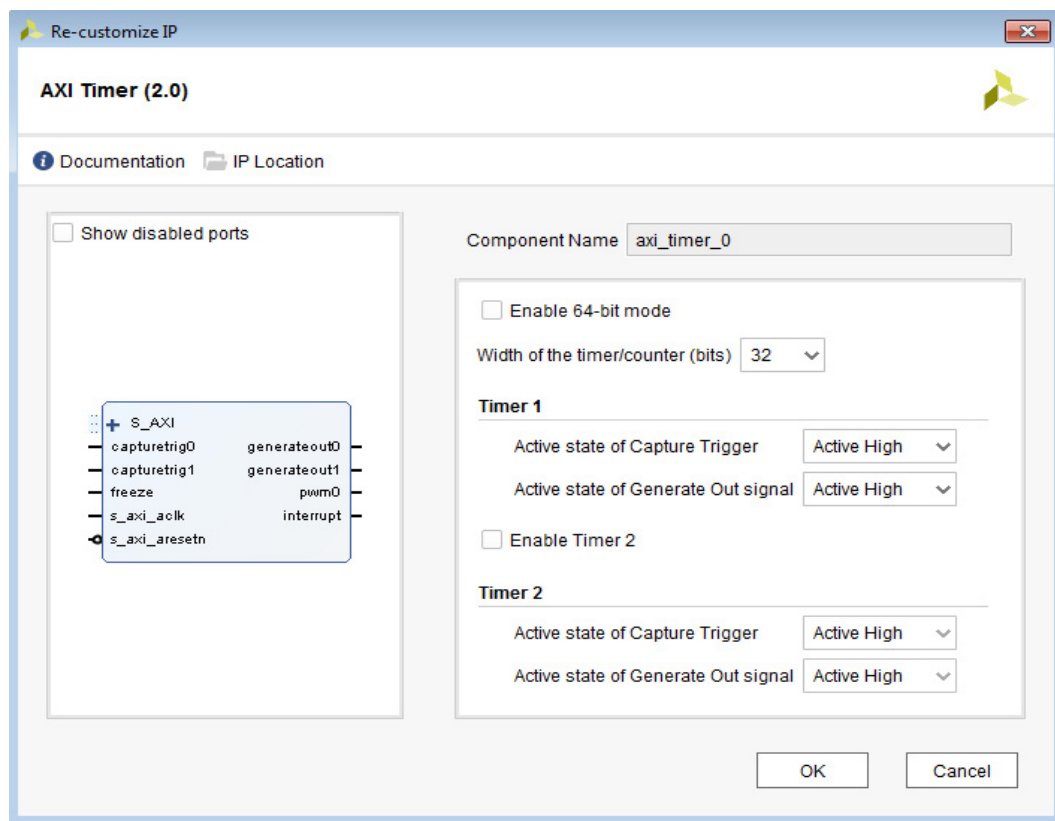

Figure 6-3: Re-customize IP Dialog Box for AXI Timer

4. Click **OK**.
5. Again, right-click in the block diagram and select **Add IP**.
6. Search for "AXI GPIO" and double-click the **AXI GPIO** IP to add it to the design.
7. Repeat [step 5](#) and [step 6](#) to add another instance of AXI GPIO IP.
8. Double-click **axi_gpio_0** and select **Push button 5bits** from the GPIO Board Interface drop-down list.

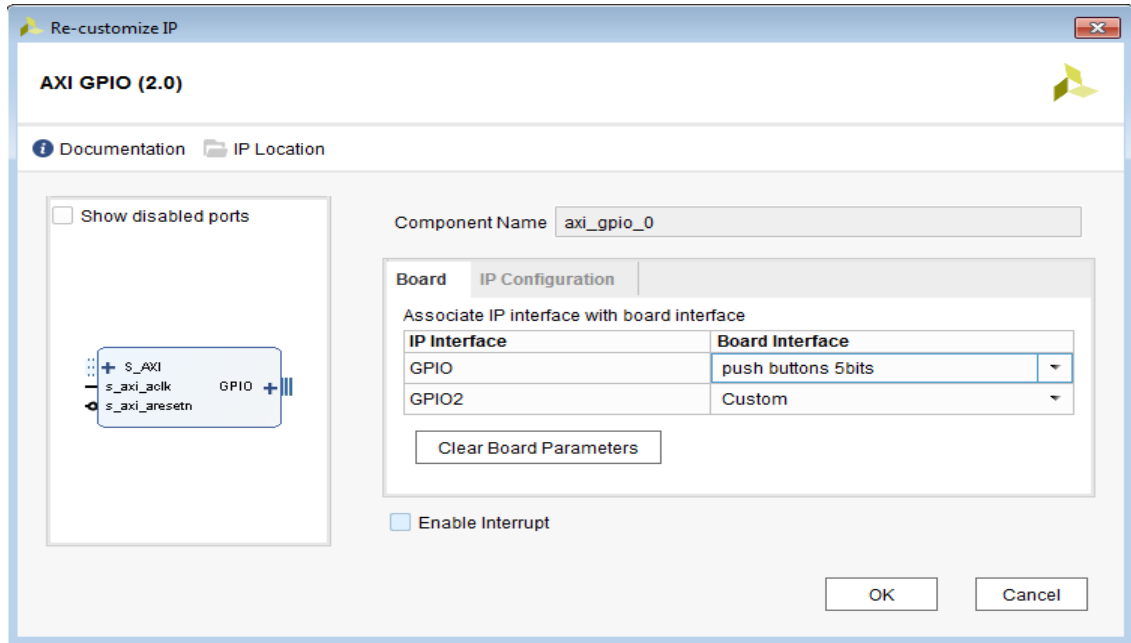

Figure 6-4: Re-customize IP Dialog Box for AXI GPIO

9. Click **OK** to configure the AXI_GPIO for Push buttons.
10. Double-click on axi_gpio_1.
11. Configure axi_gpio_1 for PL LEDs by selecting led_8bits from the **GPIO Board Interface** drop-down list, as shown in the following figure.

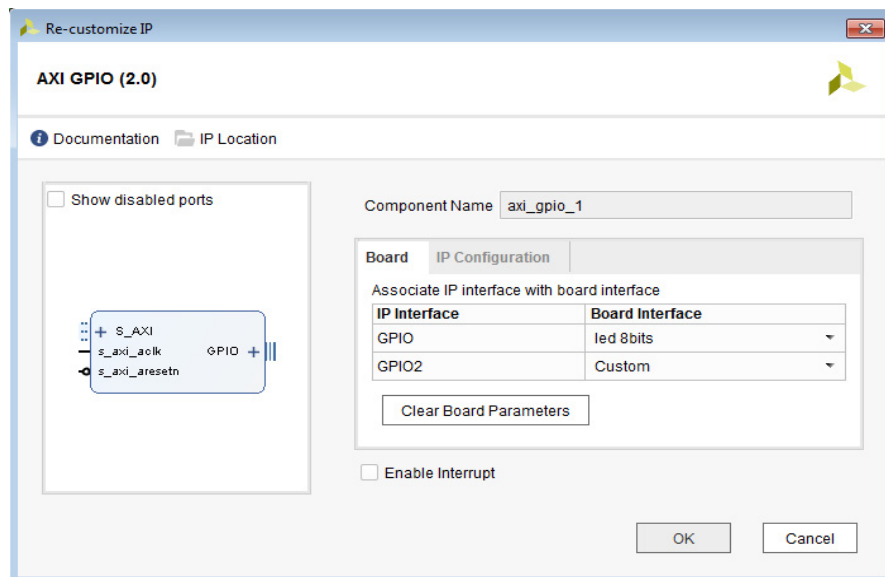

Figure 6-5: Configuring GPIO for led_8bits

12. Click **OK** to configure the AXI_GPIO for Push buttons.

Connecting IP Blocks to Create a Complete System

Make the initial connections using Board presets. To do this, follow the below steps:

1. Double-click the **Zynq UltraScale+ IP** Block, and select a PL-PS interrupt as shown in [Figure 6-6](#) (Ignore and move to the next step, if this is selected by default).

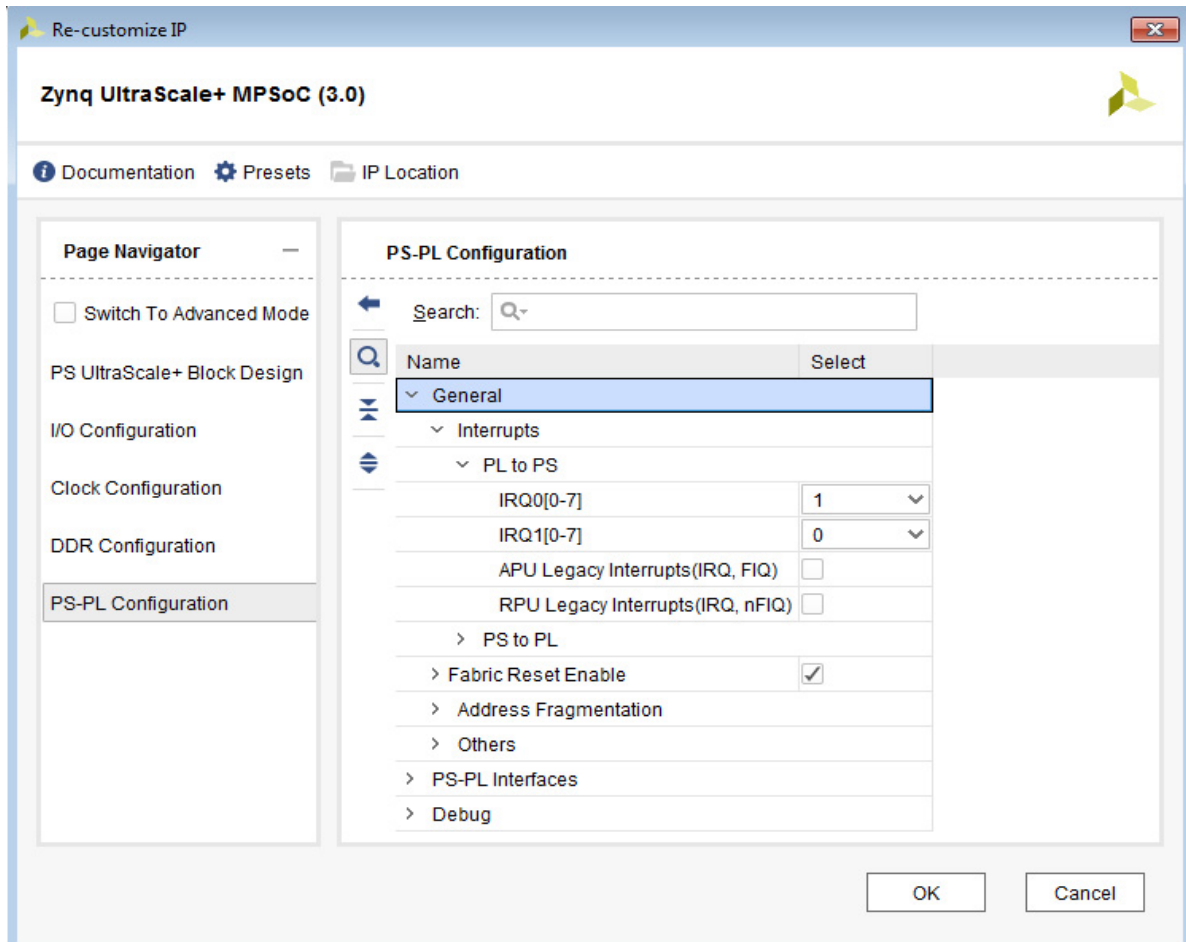

Figure 6-6: Selecting PL to PS Interrupt

2. In PS-PL Configuration, expand **PS-PL Interfaces** and expand the **Master Interface**.

- Expand **AXI HPM0 LPD** and set the **AXI HPM0 LPD Data Width** drop-down to **128 bit**, as shown in [Figure 6-7](#).

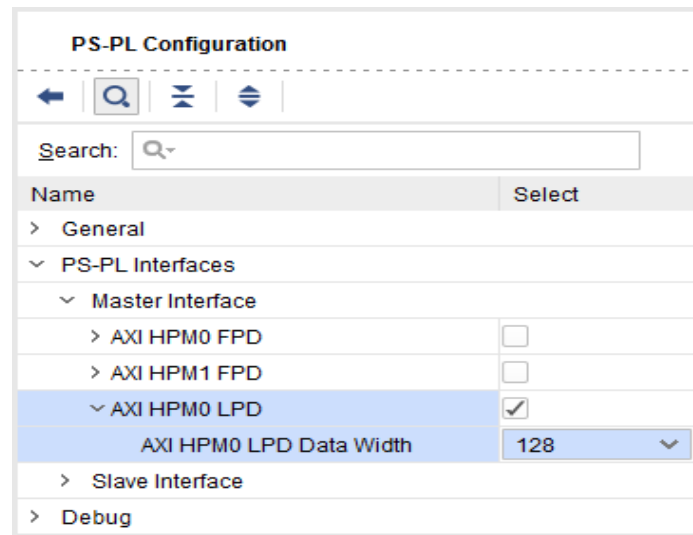

Figure 6-7: Set Data Width for AXI HPM0 LPD

- Click **OK** to complete the configuration and return to the block diagram.
- In the diagram view, connect the interrupt port from `axi_timer_0` to `pl_ps_irq[0:0]`.
- Click **Run Connection Automation**. Do not click on Run Block Automation.



Figure 6-8: Run Connection Automation Link

- In the Run Connection Automation dialog box, click **All Automation**.
- Click **OK**.
- In the Address Editor view, verify that the corresponding IPs are allocated the same Address Map, as shown in the following figure. If not, set the offset address such that they match the following figure.

The screenshot shows the 'Address Editor' window with a table of IP addresses and their ranges.

Cell	Slave Interface	Base Name	Offset Address	Range	High Address
zynq_ultra_ps_e_0					
Data (40 address bits : 0x0080000000 [512M])					
axi_timer_0	S_AXI	Reg	0x00_8000_0000	4K	0x00_8000_0FFF
axi_gpio_0	S_AXI	Reg	0x00_8000_1000	4K	0x00_8000_1FFF
axi_gpio_1	S_AXI	Reg	0x00_8000_2000	4K	0x00_8000_2FFF

Figure 6-9: Address Map for PL IPs

10. Validate the design and generate the output files for this design, as described in the following sections.

Validating the Design and Generating Output

1. Return to the block diagram view and save the Block Design (press **Ctrl + S**).
2. Right-click in the white space of the Block Diagram view and select **Validate Design**.

Alternatively, you can press the **F6** key.

A message dialog box opens and states "Validation successful. There are no errors or critical warnings in this design."

3. Click **OK** to close the message.
4. In the Block Design view, click the **Sources** tab.
5. Click **Hierarchy**.
6. In the Block Diagram, Sources window, under Design Sources, expand `edt_zcu102_wrapper`.
7. Right-click the top-level block diagram, titled `edt_zcu102_i : edt_zcu102 (edt_zcu102.bd)` and select **Generate Output Products**.

The Generate Output Products dialog box opens, as shown [Figure 6-10](#).

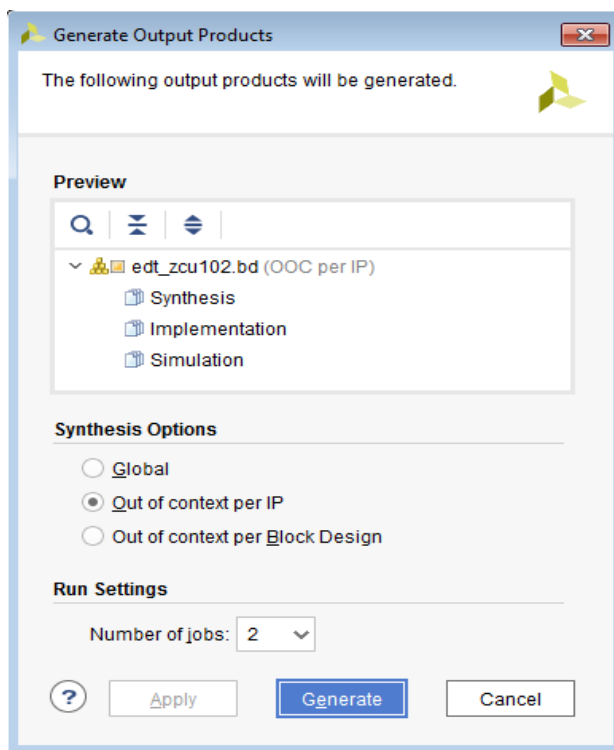

Figure 6-10: **Generate Output Products Dialog Box**

Note: If you are running the Vivado Design Suite on a Linux host machine, you might see additional options under Run Settings. In this case, continue with the default settings.

8. Click **Generate**.
9. When the Generate Output Products process completes, click **OK**.
10. In the Block Diagram Sources window, click the **IP Sources** tab. Here you can see the output products that you just generated, as shown in the following figure.

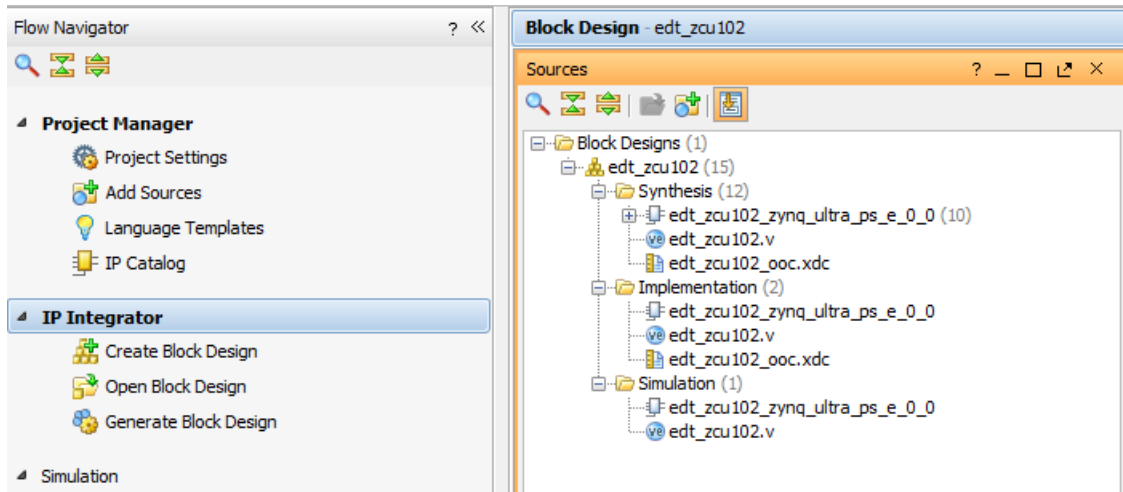

Figure 6-11: Outputs Generated Under IP Sources

Synthesizing the Design, Running Implementation, and Generating the Bitstream

1. You can now synthesize the design. In the Flow Navigator pane, under **Synthesis**, click **Run Synthesis**.

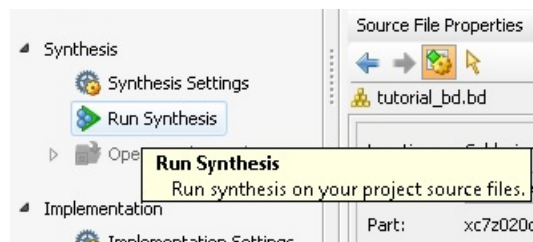

Figure 6-12: Run Synthesis Button

2. If Vivado prompts you to save your project before launching synthesis, click **Save**.

While synthesis is running, a status bar displays in the upper right-hand window. This status bar spools for various reasons throughout the design process. The status bar signifies that a process is working in the background.

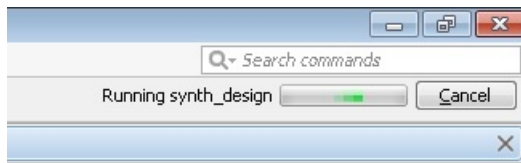

Figure 6-13: Status Bar

When synthesis completes, the Synthesis Completed dialog box opens.

3. Select Run Implementation and click **OK**.

Again, notice that the status bar describes the process running in the background. When implementation completes, the Implementation Completed dialog box opens.

4. Select Generate Bitstream and click **OK**.

When Bitstream Generation completes, the Bitstream Generation Completed dialog box opens.

5. Click **Cancel** to close the window.
6. After the Bitstream generation completes, export the hardware to SDK.

Exporting Hardware to SDK

In this example, you will launch SDK from Vivado.

1. From the Vivado toolbar, select **File > Export > Export Hardware**.

The Export Hardware dialog box opens. Make sure that the **Include bitstream** check box is checked (only when design has PL design and bitstream generated), and that the **Export to** field is set to the default option of `<Local to Project>`.

2. Click **OK**.

At this point a warning, message appears to indicate that the Hardware Module has already been exported.

3. Click **Yes** to overwrite the existing HDF file.

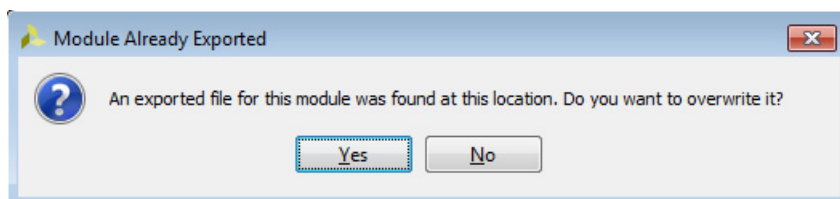

Figure 6-14: Permission to Overwrite Existing Hardware Files

- Once the Hardware files are exported, SDK also detects the new HDF and shows the following warning message.

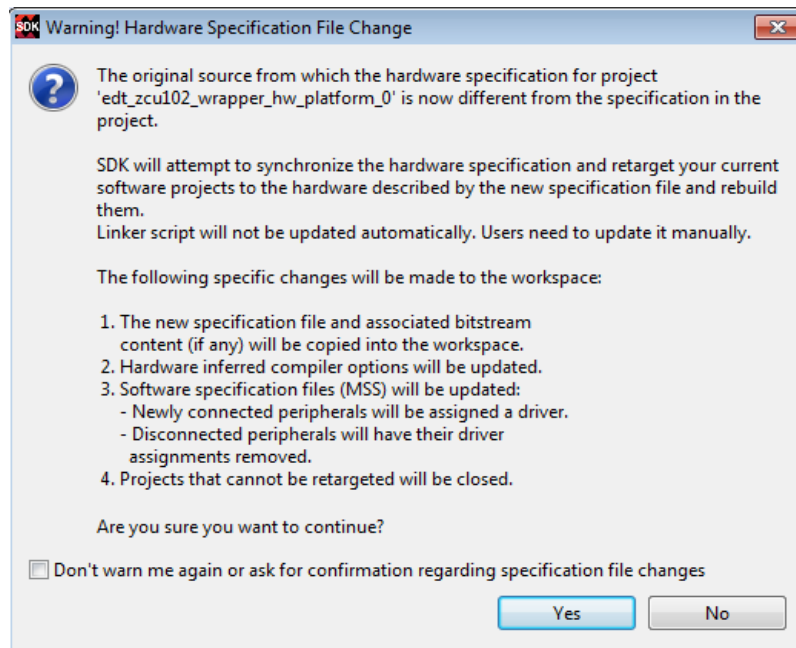

Figure 6-15: SDK Warning Message about Detecting Updated HDF

The warning message is also to check if SDK can update the project in sync with the new HDF.

- Click **Yes**.

Now the SDK project is updated in sync with the new HDF file. To verify this, look for the GPIO and AXI_Timer drivers, which were added in the BSP packages in the existing project.

Configuring Software

This use case has a bare-metal application running on an R5 core and a Linux Application running on APU Linux Target. Most of the software blocks will remain the same as mentioned in [Chapter 3](#). The software for this design example requires additional drivers for components added in the PL Logic. For this reason, you will need to generate a new Bare-metal BSP in SDK using the Hardware files generated for this design. Linux also requires the Linux BSP to be reconfigured in sync with the new hardware design file (HDF). Before you configure the software, first look at the application design scheme.

The system has a bare-metal application on RPU, which starts with toggling the PS LEDs for a user configurable period. The LEDs are set to toggle in synchronization with PL AXI Timer running in the PL block. The application sets the AXI Timer in the generate mode and generates an interrupt every time the Timer count expires. The application is designed to toggle the PS LED state after handling the Timer interrupt. The application runs in an infinite while loop and sets the RPU in WFI mode after toggling the LEDs for the user-configured time period. This LED toggling sequence can be repeated again by getting the RPU out of WFI mode using an external interrupt. For this reason, the UART interrupt is also configured and enabled in the same application. While this application runs on the RPU, the Linux target also hosts another Linux application. The Linux application uses user Input from PS or PL switches to toggle PL LEDs. This Linux application also runs in an infinite while loop, waiting for user input to toggle PL LEDs. The next set of steps show how to configure System software and build user applications for this design.

Configure and Build Linux using PetaLinux

First, create the Linux images using PetaLinux. The Linux images must be created in sync with the hardware configuration for this design. You will also need to configure PetaLinux to create images for SD boot.

See the [Example Project: Create Linux Images using PetaLinux in Chapter 3](#), and repeat steps from [step 2](#) to [step 13](#) to update the device tree and build Linux images using PetaLinux. Alternatively, you can also use the Linux image files shared with this tutorial. The images for this section can be found in `<design_files>/design`.

Follow [step 15](#) to verify the images. The next step is to create a Bare-metal Application targeted for Arm Cortex-R5 based RPU.

For this design example, you must import the application source files available in the Design Files ZIP file released with this tutorial. For information about locating these design files, see the [Design Files for This Tutorial in Appendix B](#).

Creating the Bare-Metal Application Project

1. In SDK, select **File > New > Application Project**.

The New Project wizard opens.

2. Use the information in the table below to make your selections in the wizard.

Table 6-1: Settings to Create Timer-Based RPU Application Project

Wizard Screen	System Properties	Setting or Command to Use
Application Project	Project Name	tmr_psled_r5
	Use Default Location	Select this option.
	Hardware Platform	edt_zcu102_wrapper_hw_platform_0
	OS Platform	standalone
	Processor	psu_cortexr5_0
	Language	C
	Board Support Package	Select Use Existing and select <code>r5_bsp</code> .
Templates	Available Templates	Empty Application

3. Click **Finish**.

The New Project wizard closes and SDK creates the `tmr_psled_r5` application project, which you can view in the Project Explorer.

4. In the Project Explorer tab, expand the `tmr_psled_r5` project.
5. Right-click the `src` directory, and select **Import** to open the Import dialog box.
6. Expand **General** in the Import dialog box and select **File System**.
7. Click **Next**.
8. Select **Browse** and navigate to the `design-files/design1` folder, which you saved earlier (see [Additional Resources and Legal Notices in Appendix B](#)).
9. Click **OK**.
10. Select and add the `timer_psled_r5.c` file.
11. Click **Finish**.

SDK automatically builds the application and displays the status in the console window.

Modifying the Linker Script

Note: This section is optional, it describes how the Linker Script can be modified to configure different memory attributes for the application. This is optional for this tutorial as these settings are already taken care of by the isolation created in [Chapter 2](#) of this tutorial. The Linker script helps create software boundaries, while the Isolation configuration based on XMPU provides hardware protection against any illegal access to protected regions.

1. In the Project Explorer, expand the `tmr_psled_r5` project.
2. In the `src` directory, double-click `lscript.ld` to open the linker script for this project.
3. In the linker script change the application Memory Regions (except the vectors section) to `psu_r5_ddr_0_MEM_3` which has below base address and size:

Base Address: `0x7F000000`

Size: `0xF00000`

The following figure shows the linker script modification. The following figure is for representation only. The actual memory regions may vary based on the isolation settings.

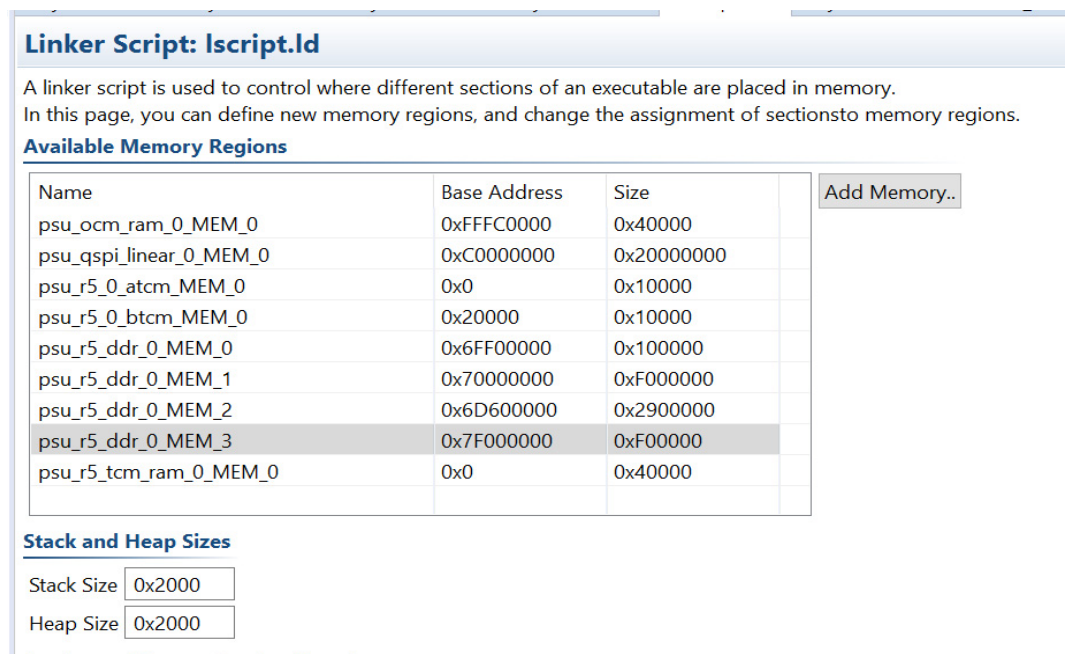

Figure 6-16: Linker Script Modification

This modification in the linker script ensures that the RPU bare-metal application resides above `0x7F000000` base address in the DDR, and occupies no more than 16 MB of size.

4. Type **Ctrl + S** to save the changes.
5. Right-click the `tmr_psled_r5` project and select **Build Project**.
6. Verify that the application is compiled and linked successfully and that the `tmr_psled_r5.elf` file was generated in the `tmr_psled_r5\Debug` folder.
7. Verify that the BSP is configured for `UART_1`. For more information, see the [Modifying the Board Support Package in Chapter 3](#).

Creating the Linux Application Project

1. In SDK, select **File > New > Application Project**.

The New Project wizard opens.

2. Use the information in the table below to make your selections in the wizard.

Table 6-2: Settings to Create New Linux Application Project

Wizard Screen	System Properties	Setting or Command to Use
Application Project	Project Name	ps_pl_linux_app
	Use Default Location	Select this option
	OS Platform	Linux
	Processor	psu_cortexA53
	Language	C
	Compiler	64-bit
Templates	Available Templates	Linux Empty Application

3. Click **Finish**.

The New Project wizard closes and SDK creates the `ps_pl_linux_app` application project, which can be found in the Project Explorer.

4. In the Project Explorer tab, expand the `ps_pl_linux_app` project.
5. Right-click the `src` directory, and select **Import** to open the Import dialog box.
6. Expand **General** in the Import dialog box and select **File System**.
7. Click **Next**.
8. Select **Browse** and navigate to the `design-files/design1` folder, which you saved earlier (see [Design Files for This Tutorial in Appendix B](#)).
9. Click **OK**.
10. Select and add the `ps_pl_linux_app.c` file.

Note: The application might fail to build because of a missing reference to the pthread Library. The next section shows how to add the pthread library.

Modifying the Build Settings

This application makes use of Pthreads from the pthread library. Add the pthread library as follows:

1. Right-click `ps_pl_linux_app`, and click on **C/C++ Build Settings**.
2. Refer to the following figures to add the `pthread` library.

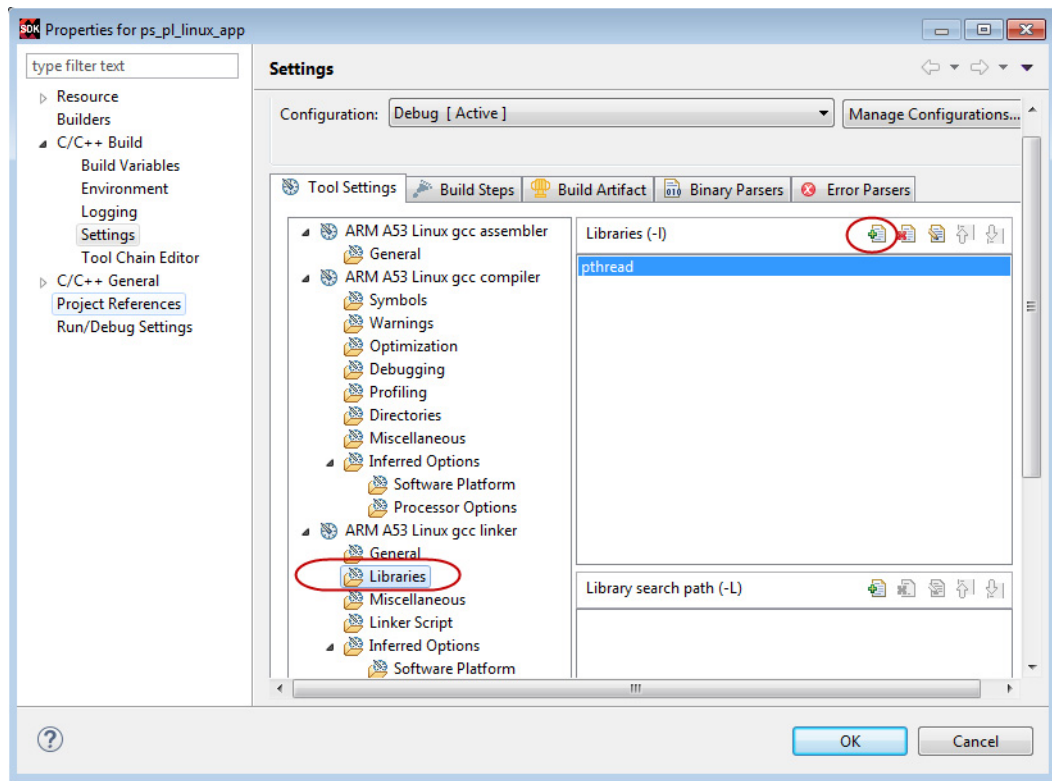

Figure 6-17: C/C++ Build Settings

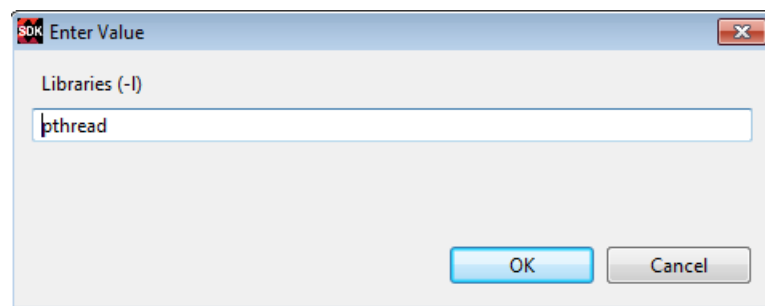

Figure 6-18: Add pthread Library

3. Click **OK** in both the windows.

SDK automatically builds the application and displays the status in the console window.

Creating a Boot Image

Now that all the individual images are ready, you will create the boot image to load all of these components on a Zynq UltraScale+ device. This can be done using the Create Boot Image wizard in SDK, using the following steps. This example creates a Boot Image BOOT.bin in C:\edt\design1.

1. Launch SDK, if it is not already running.
2. Set the workspace based on the project you created in [Chapter 2](#). For example:
C:\edt\edt_zcu102\edt_zcu102.sdk
3. Select **Xilinx > Create Boot Image**.
4. See [Figure 6-19](#) for settings in the Create Boot Image wizard.
5. Add the partitions as shown in the following figure.

Note: For detailed steps on how to add partitions, see [Boot Sequence for SD-Boot](#).

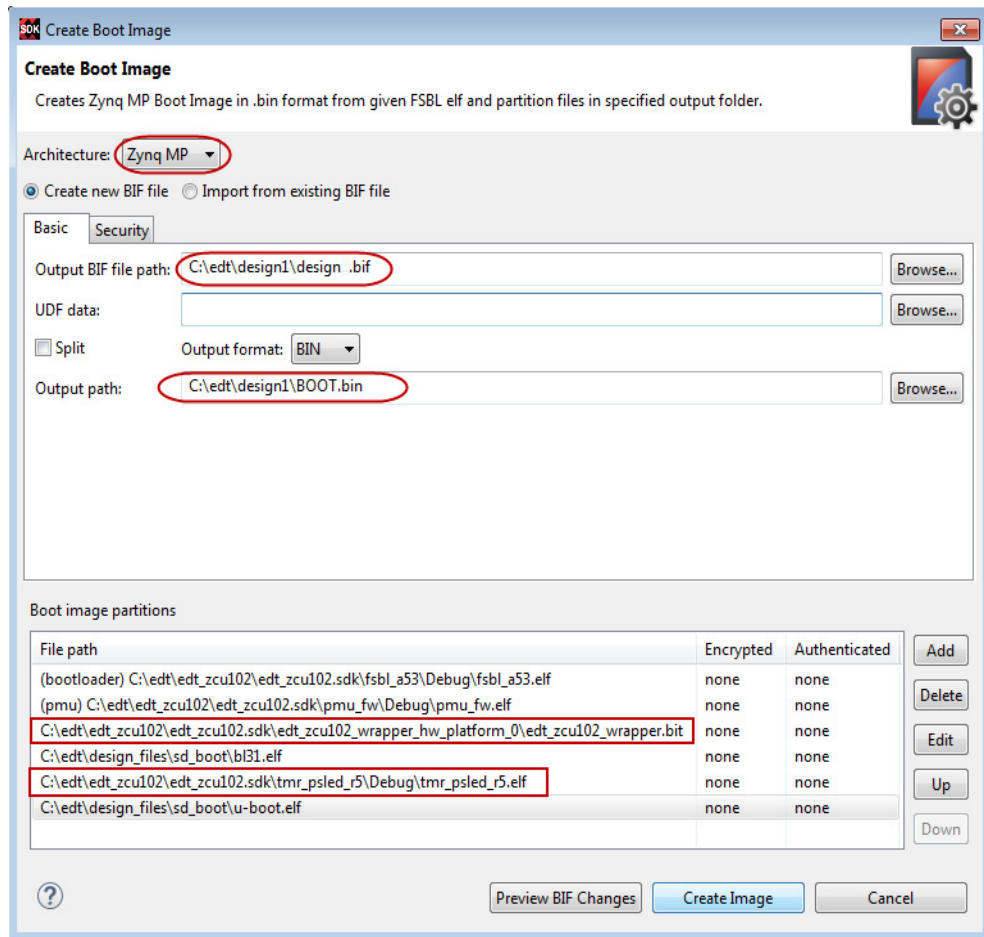

Figure 6-19: Create Boot Image for SD Boot Mode

Note: This Boot image requires PL bitstream `edt_zcu102_wrapper.bit` (Partition Type - Datafile, Destination Device - PL). The Bitstream Partition needs to be added right after the Bootloader while you create the boot image. Also note that the R5 application `tmr_ps1ed_r5.elf` is added as partition in this boot image.

6. After adding all the partitions, click **Create Image**.



IMPORTANT: Ensure that you have set the correct exception levels for ATF (EL-3, Trustzone) and U-Boot (EL-2) partitions. These settings can be ignored for other partitions.

Running the Image on a ZCU102 Board

Prepare the SD Card

Copy the images and executables on an SD card and load it in the SD card slot in the Board.

1. Copy files `BOOT.BIN` and `image.ub` to an SD card.

Note: `BOOT.BIN` is located in `C:\edt\design1`.

2. Copy the Linux application, `ps_pl_linux_app.elf`, to the same SD Card. The application can be found in:

`C:\edt\edt_zcu102\edt_zcu102.sdk\ps_pl_linux_app\Debug`

Target Setup

1. Load the SD card into the ZCU102 board, in the J100 connector.
2. Connect the USB-UART on the Board to the Host machine.
3. Connect the Micro USB cable into the ZCU102 Board Micro USB port J83, and the other end into an open USB port on the host Machine.
4. Configure the Board to Boot in SD-Boot mode by setting switch SW6 as shown in the following figure.

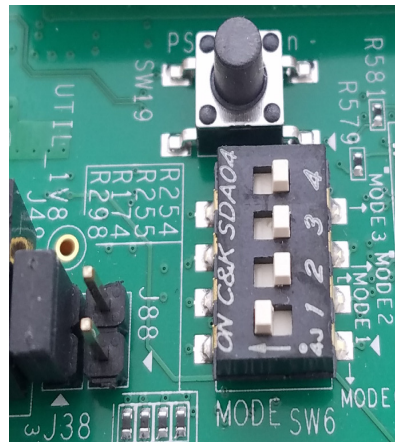

Figure 6-20: SW6 Switch Settings for SD Boot Mode

5. Connect 12V Power to the ZCU102 6-Pin Molex connector.
6. Start a terminal session, using TeraTerm or Minicom depending on the host machine being used, as well as the COM port and baud rate for your system, as shown in [Figure 5-8](#).
7. For port settings, verify the COM port in the device manager.

There are four USB-UART interfaces exposed by the ZCU102 Board.

8. Select the COM Port associated with the interface with the lowest number. In this case, for UART-0, select the COM port with interface-0.
9. Similarly, for UART-1, select COM port with interface-1.

Remember that the R5 BSP has been configured to use UART-1, and so R5 application messages will appear on the COM port with the UART-1 terminal.

Power ON Target and Run Applications

1. Turn on the ZCU102 Board using SW1, and wait until Linux loads on the board.

You can see the initial Boot sequence messages on your Terminal Screen representing UART-0.

You can see that the terminal screen configured for UART-1 also prints a message. This is the print message from the R-5 bare-metal Application running on RPU, configured to use UART-1 interface. This application is loaded by the FSBL onto RPU.

2. Now that this application is running, notice the PS LED being toggled by the application, and follow the instructions in the application terminal.

```
PS LED Turned ON
PS LED Turned OFF
PS LED Turned ON
PS LED Turned OFF
PS LED Turned ON
RPU in WFI mode. Press any key to repeat the sequence
```

Figure 6-21: R5-0 Bare Metal Application

Running Linux Applications

After Linux is up on the ZCU102 system, log in to the Linux target with login: **root** and password: **root**. The Linux target is now ready for running applications.

Run the Linux application using following steps.

1. Copy the application from SD card mount point to /tmp

```
# cp /run/media/mmcblk0p1/ps_pl_linux_app.elf /tmp
```

Note: Mount the SD card manually if you fail to find SD card contents in this location.

```
# mount /dev/mmcblk0p1 /media/
```

Copy the application to /tmp.

```
# cp /media/ps_pl_linux_app.elf /tmp
```

2. Run the application.

```
# /tmp/ps_pl_linux_app.elf
```

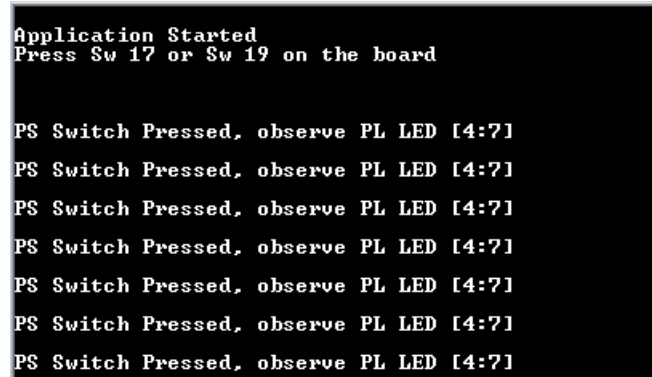

```
Application Started
Press Sw 17 or Sw 19 on the board

PS Switch Pressed, observe PL LED [4:7]
PS Switch Pressed, observe PL LED [4:7]
PS Switch Pressed, observe PL LED [4:7]
PS Switch Pressed, observe PL LED [4:7]
PS Switch Pressed, observe PL LED [4:7]
PS Switch Pressed, observe PL LED [4:7]
PS Switch Pressed, observe PL LED [4:7]
```

Figure 6-22: Linux Terminal

Design Example 2: Example Setup for Graphics and Display Port Based Sub-System

This design example is primarily based on the Graphics Processing Unit and the Display Port on a Zynq UltraScale+ MPSoC device. The main idea behind this example is to demonstrate the configurations, packages, and tool flow required for running designs based on GPU and DP on a Zynq UltraScale+ MPSoC device. This design example can be broken down into the following sections:

1. Configuring the hardware.
2. Configuring PetaLinux RootFS to include the required packages:
 - a. GPU related packages
 - b. X Window System and dependencies
3. Building Boot images and Linux images using PetaLinux.
4. Building a Graphics OpenGL ES application targeted for Mali GPU. This application is based on the X Window System.
5. Loading Linux on the ZCU102 board and running the Graphics Application on the target to see the result on the display port.

Configuring the Hardware

In this section, you will configure the processing system to set Dual lower GT lanes for the display port. The hardware configuration in this section is based on the same Vivado project that you created in [Design Example 1: Using GPIOs, Timers, and Interrupts](#).

Configuring Hardware in Vivado IP Integrator

1. Ensure that the `edt_zcu102` project and the block design are open in Vivado.
2. Double-click the Zynq UltraScale+ Processing System block in the Block Diagram window and wait till the Re-customize IP dialog box opens.
3. In Re-customize IP window, click on **I/O Configuration > High Speed**
4. De-select PCIe peripheral connection
5. Expand Display Port, and set Lane Selection to Dual Lower, as shown in following figure:

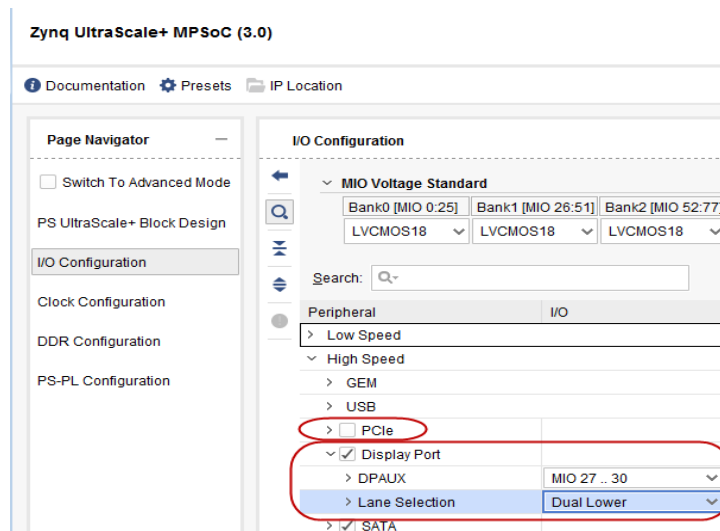

Figure 6-23: Display Port Lane Selection

Note: The Display port lane selection is set to Dual lane to support UHD@30 resolution in the design example of this tutorial. This configuration will lock display for UHD@30 as well as lower resolution like 1080p 60 and others, for corresponding monitors.

- Click **OK** to close the Re-customize IP wizard.



CAUTION! Do not click the Run Block Automation link. Clicking the link will reset the design as per board preset and disable the design updates you made using in this section.

- Click **File > Save Block Design** to save the block design. Alternatively, you can press **CTRL + S** to save the block design.
- Click **Generate Bitstream**, to re-synthesize the design and generate the Bitstream.
- After the Bitstream is generated successfully, click **File > Export > Export Hardware** to export the hardware design.
- Select **Include Bistream**.
- Click **OK**.

The exported design can be found at following location:

```
<edt_zcu102_Vivado_project_path>\edt_zcu102.sdk\edt_zcu102_wrapper.hdf
```

For this example, it can be found in

```
C:\edt\edt_zcu102\edt_zcu102.sdk\edt_zcu102_wrapper.hdf
```

- Copy the HDF file to a Linux Host machine.

The next section describes steps to build Linux for your Hardware configuration and also add additional software packages for GPU and the X Window System.

Modifying the Configuration and Building Linux Images using PetaLinux

Re-configure the PetaLinux BSP in sync with the new hardware changes. This section uses the PetaLinux project you created in [Example Project: Create Linux Images using PetaLinux](#).

1. Change to the PetaLinux directory using the following command:

```
$ cd xilinx-zcu102-2018.2
```

2. Copy the hardware platform `edt_zcu102_wrapper.hdf` in the Linux Host machine.
3. Reconfigure the BSP using the following command:

```
$ petalinux-config --get-hw-description=<path containing edt_zcu102_wrapper.hdf>/
```

The PetaLinux configuration wizard opens.

4. Save and exit the wizard without any additional configuration settings.

Wait until PetaLinux reconfigures the project.

5. Modify Device-tree for Dual Lane display port configuration by following the instructions in Xilinx Answer [69248](#). The `system-user.dtsi` (with these changes) is available in [Design Files for This Tutorial](#).
6. Clean the existing Bootloader image. This is to ensure that the bootloader is recreated in sync with new hardware design.

```
$ petalinux-build -c bootloader -x distclean
```

Building the Mali OpenGL ES Application

This section leads you through building a Triangle-based Cube application. This application is written in OpenGL ES and is based on the X Window System. For more details and for the application source code, refer to `tricube` in the `design_files` folder of the zip file that accompanies this tutorial. See [Design Files for This Tutorial](#).

Use the following steps to build the OpenGL ES application:

1. Copy the entire application source directory of `tricube` to the Linux host machine in the `recipe-apps` directory of the PetaLinux project.

```
<PetaLinux-Project>/project-spec/meta-user/recipes-apps/tricube
```

2. Add the newly created `tricube` in `petalinux-image.bbappend`, which is located in

```
<plnx_project>/project-spec/meta-user/recipes-core/images/petalinux-image.bbappend
```

With this addition, the file will look like below. Notice the new application in bold.

```
IMAGE_INSTALL_append = " peekpoke"
```



```
IMAGE_INSTALL_append = " gpio-demo"
IMAGE_INSTALL_append = " tricube"
```

3. Refer to recipe `tricube/tricube.bb` for detailed instructions and libraries used for building this application. The X Window System (X11) packages included while building the above application is application dependent. Libraries included in `tricube.bb` recipe are based on the packages that were used in the application.

Enable GPU Libraries and Other Packages in RootFS

In this section, you will use the PetaLinux rootfs Configuration wizard to add the Mali GPU libraries. PetaLinux is shipped with Mali GPU libraries and device drivers for Mali GPU. By default, the Mali driver is enabled in the kernel tree, but Mali user libraries need to be configured (on an as-needed basis) in the rootfs. In addition to this, you will use the same wizard to include the X Window System libraries.

1. Open the PetaLinux rootfs Configuration wizard -

```
$ petalinux-config -c rootfs
```

2. Navigate to and enable the following packages:

```
Filesystem Packages ---> libs ---> libmali-xlnx ---> libmali-xlnx
Filesystem Packages ---> libs ---> libmali-xlnx ---> libmali-xlnx-dev
```

These packages enable you to build and Run OpenGL ES applications targeted for Mali GPU in the Zynq UltraScale+ MPSoC device.

3. Add X11 package groups to add X window related packages:

```
Petalinux Package Groups > packagegroup-petalinux-x11 >packagegroup-petalinux-x11
Petalinux Package Groups > packagegroup-petalinux-x11 >
packagegroup-petalinux-x11-dev
```

4. Add the OpenGL ES application created in the earlier section:

```
User Packages ---> [*]tricube
```

5. After enabling all the packages, save the config file and exit the rootfs configuration settings.

6. Build the Linux images using the following command:

```
$ petalinux-build
```

Note: If the PetaLinux builds fails, use the following commands to build again:

```
$ petalinux-build -x mrproper
$ petalinux-build
```

7. Verify that the `image.ub` Linux image file is generated in the `images/linux` directory.

8. Generate the Boot image for this design example as follows:

```
$ petalinux-package --boot --fsbl images/linux/zynqmp_fsbl.elf --pmufw
images/linux/pmufw.elf --atf images/linux/bl31.elf --fpga images/linux/system.bit
--u-boot images/linux/u-boot.elf
```

A `BOOT.BIN` Boot image is created. It is composed of the FSBL boot loader, the PL bitstream, PMU firmware and ATF, and U-Boot. Alternatively, see the steps in [Creating a Boot Image](#) to create this boot image.



IMPORTANT: *This example uses the GPU packages based on X window system, which is the default setting in PetaLinux 2018.2. To enable Frame Buffer fbdev based GPU Packages in PetaLinux 2018.2, add the following line in `<PetaLinux_project>/project-spec/meta-user/conf/petalinuxbsp.conf`.*

`DISTRO_FEATURES_remove_zynqmp = "x11"`

See example `eglfbdev` application (based on `fdev`) available in [Design Files for This Tutorial](#). For more information, see the Xilinx Answer [68821](#).

Loading Linux and Running the OpenGL Application on the Target and Viewing the Result on the Display Port

Preparing the SD Card

Now that the Linux images are built and the application is also built, copy the following images in an SD card and load the SD card in ZCU102 board.

- `BOOT.BIN`
- `Image.ub`

Running the Application on a Linux Target

Setting Up the Target

Do the following to set up the Target:

1. Load the SD card into the J100 connector of the ZCU102 board.
2. Connect the Micro USB cable into the ZCU102 Board Micro USB port J83, and the other end into an open USB port on the host Machine.
3. Connect a Display Port monitor to the ZCU102 Board. The display port cable from the DP monitor can be connected to the display port connector on the ZCU102 board.

Note: These images were tested on a UHD@30 Hz and a FullHD@60 Hz Display Port capable monitor.

- Configure the Board to Boot in SD-Boot mode by setting switch SW6 as shown in the following figure.

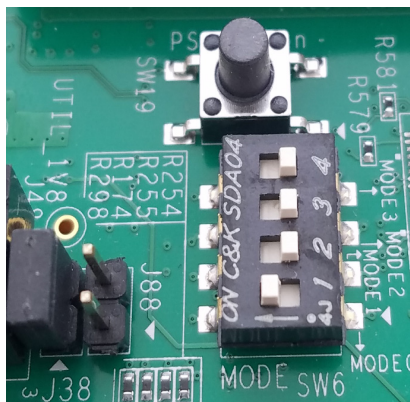

Figure 6-24: SW6 Switch Settings for SD Boot Mode

- Connect 12V Power to the ZCU102 6-Pin Molex connector.
- Start a terminal session, using TeraTerm or Minicom depending on the host machine being used, as well as the COM port and baud rate for your system, as shown in [Figure 5-8](#).
- For port settings, verify the COM port in the device manager.

There are four USB-UART interfaces exposed by the ZCU102 Board. Select the COM port associated with the interface with the lowest number. In this case, for UART-0, select the COM port with interface-0.

Powering On the Target and Running the Applications

- Turn on the ZCU102 Board using SW1, and wait until Linux loads on the board.
- After Linux loads, log in to the target Linux console using `root` for the login and password.
- Set the display parameters and start Xorg with the correct depth.

```
# export DISPLAY=:0.0
# /usr/bin/Xorg -depth 16&
```

- Run the tricube application.

```
# tricube
```

At this point, you can see a rotating multi-colored cube and a rotating triangle on the display port. Notice that the cube is also made of multi-colored triangles.

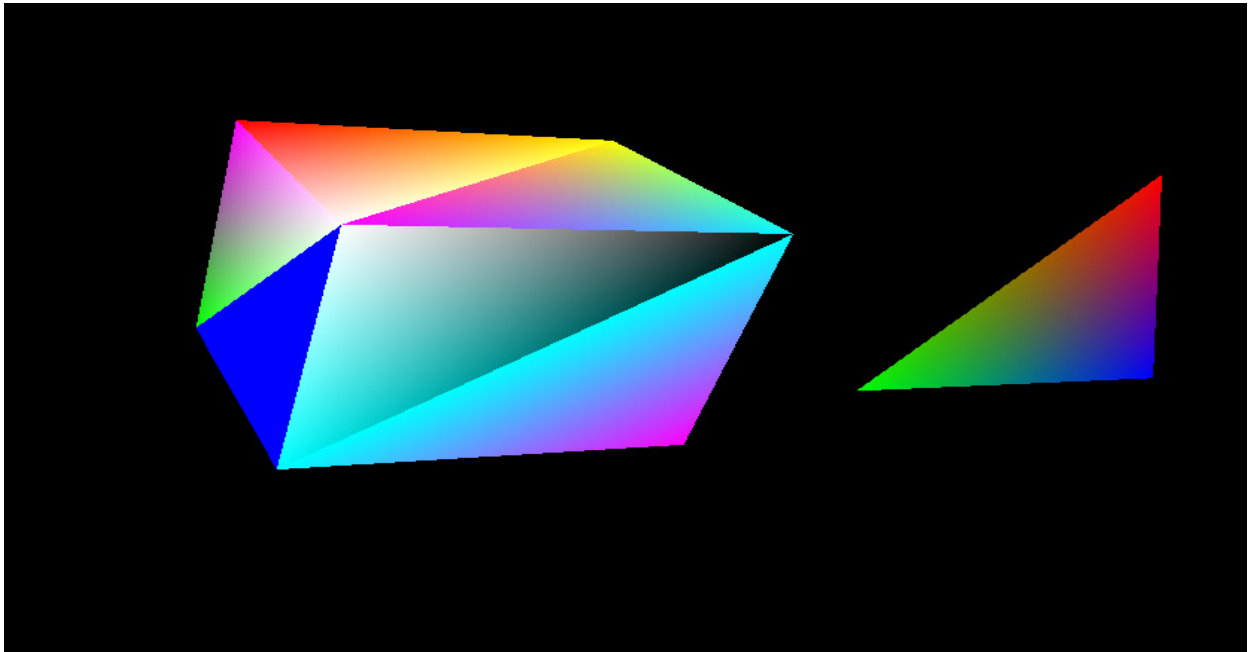

Figure 6-25: Rotating Cube and Triangle

Debugging Problems with Secure Boot

This appendix describes how to debug security failures. One procedure determines if PUF registration has been run on the device. A second procedure checks the value of the Boot Header in the boot image.

Determine if PUF Registration is Running

The following steps can be used to verify if the PUF registration software has been run on the device:

1. In SDK, select **Xilinx > XSCT Console**.

2. Enter the following commands at the prompt:

```
xsct% connect
xsct% targets
xsct% targets -set -filter {name =~ "Cortex-A53 #0"}
xsct% rst -processor
xsct% mrd -force 0xFFCC1050 (0xFFCC1054)
```

3. This location contains the CHASH and AUX values. If non-zero, PUF registration software has been run on the device.

Read the Boot Image

You can use the Bootgen Utility to verify the header values and the partition data used in the Boot Image.

1. Change to the directory containing `BOOT.bin`.
2. From an XSCT prompt, run the following command.

```
bootgen_utility -bin BOOT.bin -out myfile -arch zynqmp
```

3. Look for "BH" in myfile.

Additional Resources and Legal Notices

Xilinx Resources

For support resources such as Answers, Documentation, Downloads, and Forums, see [Xilinx Support](#).

Solution Centers

See the [Xilinx Solution Centers](#) for support on devices, software tools, and intellectual property at all stages of the design cycle. Topics include design assistance, advisories, and troubleshooting tips.

Documentation Navigator and Design Hubs

Xilinx Documentation Navigator provides access to Xilinx documents, videos, and support resources, which you can filter and search to find information. To open the Xilinx Documentation Navigator (DocNav):

- From the Vivado IDE, select **Help > Documentation and Tutorials**.
- On Windows, select **Start > All Programs > Xilinx Design Tools > DocNav > DocNav**.
- At the Linux command prompt, enter `docnav`.

Xilinx Design Hubs provide links to documentation organized by design tasks and other topics, which you can use to learn key concepts and address frequently asked questions. To access the Design Hubs:

- In the Xilinx Documentation Navigator, click the **Design Hubs View** tab.
- On the Xilinx website, see the [Design Hubs](#) page.

Note: For more information on Documentation Navigator, see the [Documentation Navigator](#) page on the Xilinx website.

Available in Documentation Navigator, design hubs provide quick access to documentation, training, and information for specific design tasks. The following design hubs are applicable to embedded development and the methods described in this guide:

- [PetaLinux Tools Design Hub](#)
- [Software Development Kit Design Hub](#)

Design Files for This Tutorial

The ZIP file associated with this document contains the design files for the tutorial. You can download this file from [here](#).

To view the contents of the ZIP file, download and extract the contents from the ZIP file to C:\edt. The design files contain the HDF files, source code and prebuilt images for all the sections.

Xilinx Resources

The following Xilinx Vivado Design Suite and Zynq® UltraScale+™ guides are referenced in this document.

1. *Vivado Design Suite User Guide: Getting Started* ([UG910](#))
2. *Vivado Design Suite Tutorial: Embedded Processor Hardware Design* ([UG940](#))
3. *Vivado Design Suite User Guide: Release Notes, Installation, and Licensing* ([UG973](#))
4. *UltraFast Embedded Design Methodology Guide* ([UG1046](#))
5. *Zynq UltraScale+ MPSoC Technical Reference Manual* ([UG1085](#))
6. *Zynq UltraScale+ MPSoC Software Developer Guide* ([UG1137](#))
7. *PetaLinux Tools Documentation: Reference Guide* ([UG1144](#))
8. *Xilinx Software Development Kit (SDK) User Guide: System Performance Analysis* ([UG1145](#))
9. *Zynq UltraScale+ Processing System Product Guide* ([PG201](#))
10. *Measured Boot of Zynq-7000 SoCs* ([XAPP1309](#))
11. *Secure Boot of Zynq-7000 SoC* ([XAPP1175](#))
12. *Changing the Cryptographic Key in Zynq-7000 SoC* ([XAPP1223](#))
13. *Programming BBRAM and eFUSES* ([XAPP1319](#))

Support Resources

14. [Xilinx Zynq UltraScale+ MPSoC Solution Center](#)
15. The Software Zone:
<https://www.xilinx.com/products/design-tools/software-zone/sdsoc.html#docsdownload>

Additional Resources

16. The Effect and Technique of System Coherence in Arm Multicore Technology by John Goodacre, Senior Program Manager, Arm Processor Division
(<http://www.mpsoc-forum.org/previous/2008/slides/8-6%20Goodacre.pdf>)
 17. Xilinx GitHub website: <https://github.com/xilinx>
 18. The Linux Kernel Module Programming Guide:
<http://ltdp.org/LDP/lkmpg/2.6/html/index.html>
-

Training Resources

Xilinx provides a variety of training courses and QuickTake videos to help you learn more about the concepts presented in this document. Use these links to explore related videos:

1. [Vivado Design Suite QuickTake Video Tutorials](#)

Please Read: Important Legal Notices

The information disclosed to you hereunder (the "Materials") is provided solely for the selection and use of Xilinx products. To the maximum extent permitted by applicable law: (1) Materials are made available "AS IS" and with all faults, Xilinx hereby DISCLAIMS ALL WARRANTIES AND CONDITIONS, EXPRESS, IMPLIED, OR STATUTORY, INCLUDING BUT NOT LIMITED TO WARRANTIES OF MERCHANTABILITY, NON-INFRINGEMENT, OR FITNESS FOR ANY PARTICULAR PURPOSE; and (2) Xilinx shall not be liable (whether in contract or tort, including negligence, or under any other theory of liability) for any loss or damage of any kind or nature related to, arising under, or in connection with, the Materials (including your use of the Materials), including for any direct, indirect, special, incidental, or consequential loss or damage (including loss of data, profits, goodwill, or any type of loss or damage suffered as a result of any action brought by a third party) even if such damage or loss was reasonably foreseeable or Xilinx had been advised of the possibility of the same. Xilinx assumes no obligation to correct any errors contained in the Materials or to notify you of updates to the Materials or to product specifications. You may not reproduce, modify, distribute, or publicly display the Materials without prior written consent. Certain products are subject to the terms and conditions of Xilinx's limited warranty, please refer to Xilinx's Terms of Sale which can be viewed at <https://www.xilinx.com/legal.htm#tos>; IP cores may be subject to warranty and support terms contained in a license issued to you by Xilinx. Xilinx products are not designed or intended to be fail-safe or for use in any application requiring fail-safe performance; you assume sole risk and liability for use of Xilinx products in such critical applications, please refer to Xilinx's Terms of Sale which can be viewed at <https://www.xilinx.com/legal.htm#tos>.

AUTOMOTIVE APPLICATIONS DISCLAIMER

AUTOMOTIVE PRODUCTS (IDENTIFIED AS "XA" IN THE PART NUMBER) ARE NOT WARRANTED FOR USE IN THE DEPLOYMENT OF AIRBAGS OR FOR USE IN APPLICATIONS THAT AFFECT CONTROL OF A VEHICLE ("SAFETY APPLICATION") UNLESS THERE IS A SAFETY CONCEPT OR REDUNDANCY FEATURE CONSISTENT WITH THE ISO 26262 AUTOMOTIVE SAFETY STANDARD ("SAFETY DESIGN"). CUSTOMER SHALL, PRIOR TO USING OR DISTRIBUTING ANY SYSTEMS THAT INCORPORATE PRODUCTS, THOROUGHLY TEST SUCH SYSTEMS FOR SAFETY PURPOSES. USE OF PRODUCTS IN A SAFETY APPLICATION WITHOUT A SAFETY DESIGN IS FULLY AT THE RISK OF CUSTOMER, SUBJECT ONLY TO APPLICABLE LAWS AND REGULATIONS GOVERNING LIMITATIONS ON PRODUCT LIABILITY.

© Copyright 2017-2018 Xilinx, Inc. Xilinx, the Xilinx logo, Artix, ISE, Kintex, Spartan, Virtex, Vivado, Zynq, and other designated brands included herein are trademarks of Xilinx in the United States and other countries. AMBA, AMBA Designer, ARM, ARM1176JZ-S, CoreSight, Cortex, PrimeCell, and MPCore are trademarks of ARM in the EU and other countries. All other trademarks are the property of their respective owners.