

MIPI CSI-2 Receiver Subsystem v4.1

Product Guide

Vivado Design Suite

PG232 November 22, 2019



Table of Contents

IP Facts

Chapter 1: Overview

Sub-Core Details	6
Applications	12
Unsupported Features	12
Licensing and Ordering	13

Chapter 2: Product Specification

Standards	14
Performance	14
Resource Utilization	17
Port Descriptions	17
Register Space	21

Chapter 3: Designing with the Subsystem

General Design Guidelines	38
Shared Logic	38
I/O Planning	43
Clocking	45
Resets	48
Protocol Description	49

Chapter 4: Design Flow Steps

Customizing and Generating the Subsystem	52
Constraining the Subsystem	61
Simulation	63
Synthesis and Implementation	63

Chapter 5: Application Example Design

ZCU102 Application Example Design Overview	64
Setup Details	66
SP701 Application Example Design Overview:	70
Setup Details	70

Running the Design on the Hardware	73
Implementing the Example Design.....	74
Appendix A: Verification, Compliance, and Interoperability	
Hardware Validation	85
Appendix B: Debugging	
Finding Help on Xilinx.com	88
Debug Tools	89
Hardware Debug	90
Interface Debug	91
Appendix C: Additional Resources and Legal Notices	
Xilinx Resources	94
Documentation Navigator and Design Hubs	94
References	95
Revision History	96
Please Read: Important Legal Notices	98

Introduction

The Mobile Industry Processor Interface (MIPI) Camera Serial Interface (CSI-2) RX subsystem implements a CSI-2 receive interface according to the MIPI CSI-2 standard v2.0 [Ref 1] with underlying MIPI D-PHY standard v1.2. The subsystem captures images from MIPI CSI-2 camera sensors and outputs AXI4-Stream video data ready for image processing. The subsystem allows fast selection of the top level parameters and automates most of the lower level parameterization. The AXI4-Stream video interface allows a seamless interface to other AXI4-Stream-based subsystems.

Features

- Support for 1 to 4 D-PHY lanes
- Line rates ranging from 80 to 2500 Mb/s
- Multiple Data Type support (RAW, RGB, YUV)
- Filtering based on Virtual Channel Identifier
- Support for 1, 2, or 4 pixels per sample at the output as defined in the Xilinx *AXI4-Stream Video IP and System Design Guide* (UG934) [Ref 2] format
- AXI4-Lite interface for register access to configure different subsystem options
- Dynamic selection of active lanes within the configured lanes during subsystem generation.
- Interrupt generation to indicate subsystem status information
- Internal D-PHY allows direct connection to image sources
- Support for MIPI CSI-2 standard v2.0 features such as VCX, RAW16, and RAW20

IP Facts Table	
Subsystem Specifics	
Supported Device Family ⁽¹⁾	UltraScale+™, Zynq® UltraScale+ MPSoC, Zynq®-7000 SoC, 7 Series FPGAs
Supported User Interfaces	AXI4-Lite, AXI4-Stream
Resources	Performance and Resource Utilization web page
Provided with Subsystem	
Design Files	Encrypted RTL
Example Design	Vivado IP Integrator
Test Bench	Not Provided
Constraints File	XDC
Simulation Model	Not Provided
Supported S/W Driver ⁽²⁾	Standalone and Linux
Tested Design Flows ⁽³⁾	
Design Entry	Vivado® Design Suite
Simulation	For supported simulators, see the Xilinx Design Tools: Release Notes Guide .
Synthesis	Vivado Synthesis
Support	
Release Notes and Known Issues	Master Answer Record: 65242
All Vivado IP Change Logs	Master Vivado IP Change Logs: 72775
Xilinx Support web page	

Notes:

1. For a complete list of supported devices, see the Vivado IP catalog.
2. Standalone driver details can be found in the Vitis directory (<install_directory>/Vitis/<release>/data/embeddedsw/doc/xilinx_drivers.htm). Linux OS and driver support information is available from the [Xilinx Wiki page](#).
3. For the supported versions of the tools, see the [Xilinx Design Tools: Release Notes Guide](#).

Overview

The MIPI CSI-2 RX subsystem allows you to quickly create systems based on the MIPI protocol. It interfaces between MIPI-based image sensors and an image sensor pipe. An internal high speed physical layer design, D-PHY, is provided that allows direct connection to image sources. The top level customization parameters select the required hardware blocks needed to build the subsystem. [Figure 1-1](#) shows the subsystem architecture.

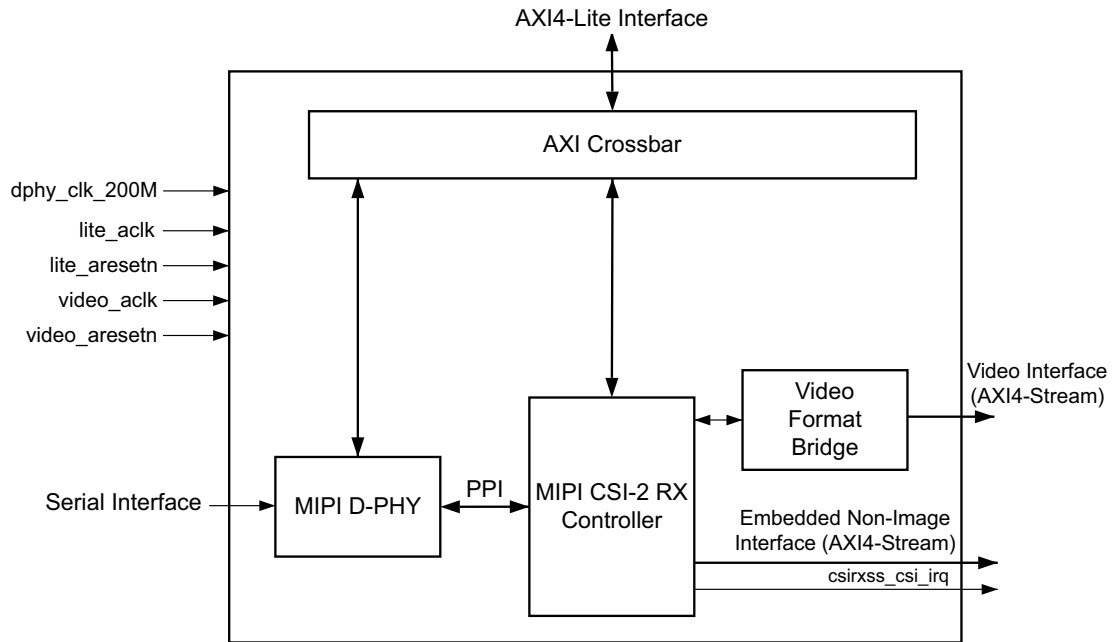

X14819-031416

Figure 1-1: Subsystem Architecture

The subsystem consists of the following sub-cores:

- MIPI D-PHY
- MIPI CSI-2 RX Controller
- AXI Crossbar
- Video Format Bridge

Sub-Core Details

MIPI D-PHY

The MIPI D-PHY IP core implements a D-PHY RX interface and provides PHY protocol layer support compatible with the CSI-2 RX interface. The MIPI D-PHY IP core also supports the deskew pattern detection for line rates >1.5 Gb/s. See the *MIPI D-PHY LogiCORE IP Product Guide* (PG202) [Ref 3] for details. MIPI D-PHY implementation differs for the UltraScale+ devices and the 7 Series devices with respect to I/O.

For UltraScale+ devices, the Vivado IDE provides a [Pin Assignment Tab](#) to select the required I/O. However, for the 7 series devices the clock capable I/O should be selected manually. In addition, the 7 series devices do not have a native MIPI IOB support. You will have to target either HR bank I/O or HP bank I/O for the MIPI IP implementation. For more information on MIPI IOB compliant solution and guidance, refer *D-PHY Solutions* (XAPP894) [Ref 14].

MIPI CSI-2 RX Controller

The MIPI CSI-2 RX Controller core consists of multiple layers defined in the MIPI CSI-2 RX 1.1 specification, such as the lane management layer, low level protocol and byte to pixel conversion.

The MIPI CSI-2 RX Controller core receives 8-bit data per lane, with support for up to 4 lanes, from the MIPI D-PHY core through the PPI. As shown in [Figure 1-1](#) the byte data received on the PPI is then processed by the low level protocol module to extract the real image information. The final extracted image is made available to the user/processor interface using the AXI4-Stream protocol. The lane management block always operates on 32-bit data received from PPI irrespective number of lanes.

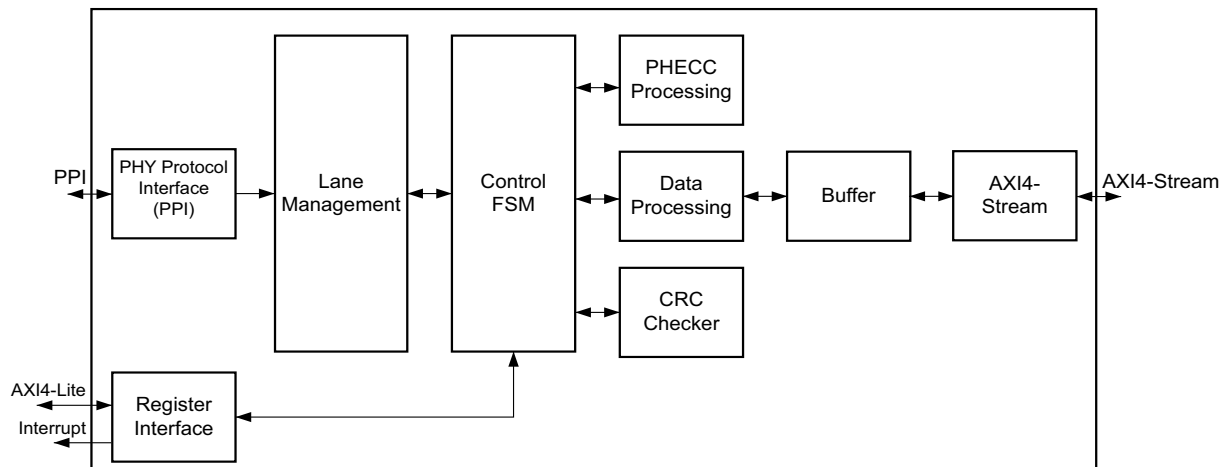

X16317-031116

Figure 1-2: MIPI CSI-2 RX Controller Core

Features of this core include:

- 1–4 lane support, with register support to select active lanes (the actual number of available lanes to be used)
- Short and long packets with all word count values supported
- Primary and many secondary video formats supported
- Data Type (DT) interleaving
- Virtual Channel Identifier (VC) interleaving
- Combination of Data Type and VC interleaving
- Multi-lane interoperability
- Error Correction Code (ECC) for 1-bit error correction and 2-bit error detection in packet header
- CRC check for payload data
- Long packet ECC/CRC forwarding capability for downstream IPs
- Maximum data rate of 2.5 Gb/s
- Pixel byte packing based on data format
- AXI4-Lite interface to access core registers
- Low power state detection
- Error detection (D-PHY Level Errors, Packet Level Errors, Protocol Decoding Level Errors)
- AXI4-Stream interface with 32/64-bit TDATA width support to offload pixel information externally
- Interrupt support for indicating internal status/error information

As shown in [Table 1-1](#) the embedded non-image (with data type code 0x12) AXI4-Stream interface data width is selected based on the Data Type selected.

Table 1-1: Embedded Non-Image AXI4-Stream Interface TDATA Widths

Data Type (DT)	AXI4-Stream Interface TDATA Width
RAW6	32
RAW7	32
RAW8	32
RAW10	64
RAW12	64
RAW14	64
RAW16	64
RAW20	64
All RGB	64
YUV 422 8-bit	64
YUV 422 10-bit	64

Abrupt termination events such as a soft reset, disabling a core while a packet is being written to the line buffer, or a line buffer full condition results in early termination. The termination is implemented by assertion of EOL on the video interface or TLAST and TUSER[1] on the embedded non-image interface, based on the current long packet being processed.

ECC/CRC Forwarding

Sideband signals of AXI4-Stream interface [Include/Exclude Video Format Bridge and Embedded non-image interface] report ECC and CRC data received from the source [sensor] to downstream IPs. This allows to re-calculate ECC/CRC by the downstream IPs in certain functional safety applications. See [Port Descriptions](#) for details on signal mapping.

In error scenarios like abrupt termination due to soft reset, disabling the core while packet transfer in progress, line buffer in full condition, word count of received packet is greater than the actual payload, these sideband signals do not report the correct ECC and CRC.

VCX Support

The MIPI CSI-2 standard v2.0 specific VCX support feature is used to extend the maximum number of available virtual channels to 16. When this feature is enabled, the virtual channel is deduced by combining the 2-bit VC field (LSB) and the 2-bit VCX field (MSB) from the packet header.

AXI Crossbar

The AXI Crossbar core is used in the subsystem to route AXI4-Lite requests to corresponding sub-cores based on the address. See the *AXI Interconnect LogiCORE IP Product Guide* (PG059) [Ref 4] for details.

Video Format Bridge

The Video Format Bridge core uses the user-selected VC and Data Type information to filter only the required AXI4-Stream data beats. This AXI4-Stream data is further processed based on the Data Type information and the output is based on the requested number of pixels per beat. The output interface adheres to the protocol defined in the *AXI4-Stream Video IP and System Design Guide* (UG934) [Ref 2].

The Video Format Bridge core processes the data type selected in the Vivado Integrated Design Environment (IDE) and filters out all other data types except for RAW8 and User Defined Byte-based Data types (0x30 to 0x37) received from the CSI-2 RX Controller.

Irrespective of the Vivado IDE selection, RAW8 and User Defined Byte-based Data types are always processed by the Video Format Bridge core. This allows multiple data-type support, one main data-type from the Vivado IDE for pixel data and a User Defined Byte-based Data type for metadata. When multiple data types are transferred (for example, RAW10 and User Defined Byte-based Data) the actual placement pixel data bits are defined in the *AXI4-Stream Video IP and System Design Guide* (UG934) [Ref 2].

For unaligned transfers there is no way to specify the partial final output (TKEEP) for the output interface. Ensure that you take this into consideration and discard the unintended bytes in the last beats when there are un-aligned transfers.

video_out Port Width

The width of the data port in the `video_out` interface depends on the data type selected and number of pixels per beat selected. The width is a maximum of the RAW8 and the data type selected in the Vivado IDE multiplied by number of pixels per beat. This is then rounded to the nearest byte boundary as per the AXI4-Stream protocol.

Example 1: RAW10 and Two Pixels per Clock Selected in the Vivado IDE

- Single pixel width of RAW10 = 10
- Single pixel width of RAW8 = 8

For the selected two pixels per clock, the effective pixels widths are 20 and 16 for RAW10 and RAW8 respectively. The `video_out` port width is configured as the maximum of the individual pixel widths, and rounded to the nearest byte boundary. This results in a `video_out` port width of 24.

Example 2: RAW7 and Four Pixels per Clock Selected in the Vivado IDE

- Single pixel width of RAW7 = 7
- Single pixel width of RAW8 = 8

With four pixels per clock selected, the effective pixels widths are 28 and 32 for RAW7 and RAW8 respectively. The video_out port width is configured as the maximum of the individual pixel widths, and rounded to nearest byte boundary. This results in a video_out port width of 32.

Pixel Packing for Multiple Data Types

When multiple pixels are transferred with different pixel width, the pixels with lower width are justified to most significant bits.

Example 1

When RAW12 and RAW8 are transferred with two pixels per clock, the data port width of the video_out interface is 24-bits. Within the 24-bits the RAW8 pixels are aligned to the most significant bits as shown in the following table:



IMPORTANT: In a multi pixel scenario pixel width varies, pixels with lower width are justified to the most significant bit.

Table 1-2: Pixel Packing for RAW12 and RAW8 Data Types

Bit Positions	23	22	21	20	19	18	17	16	15	14	13	12	11	10	9	8	7	6	5	4	3	2	1	0
RAW12	q11	q10	q9	q8	q7	q6	q5	q4	q3	q2	q1	q0	p11	p10	p9	p8	p7	p6	p5	p4	p3	p2	p1	p0
RAW8	q7	q6	q5	q4	q3	q2	q1	q0					p7	p6	p5	p4	p3	p2	p1	p0				

Notes:

1. p0 to p11 is the 1st pixel bits of RAW12; q0 to q11 is the 2nd pixel bits of RAW12.
2. p0 to p7 is the 1st pixel bits of RAW8; q0 to q7 is the 2nd pixel bits of RAW8.

Example 2

When the core is configured with RAW6 and two pixels per clock, the video_out port width is set to 16-bits. Within the 16-bits the RAW6 and RAW8 pixels are aligned to the most significant bits as shown in the following table:

Table 1-3: Pixel Packing for RAW8 and RAW6 Data Types

Bit Positions	15	14	13	12	11	10	9	8	7	6	5	4	3	2	1	0
RAW8	q7	q6	q5	q4	q3	q2	q1	q0	p7	p6	p5	p4	p3	p2	p1	p0
RAW6	q5	q4	q3	q2	q1	q0			p5	p4	p3	p2	p1	p0		

Notes:

1. p0 to p7 is the 1st pixel bits of RAW8; q0 to q7 is the 2nd pixel bits of RAW8.
2. p0 to p5 is the 1st pixel bits of RAW6; q0 to q5 is the 2nd pixel bits of RAW6.

Pixel Packing for Embedded Non-Image Data Types

AXI4-Stream TDATA width is based on main data type selected from the Vivado® IDE. The position of embedded non-image data type bytes on `emb_nonimg_tdata` are listed below:

- 1st byte on `emb_nonimg_tdata[7:0]`
- 2nd byte on `emb_nonimg_tdata[15:8]` and so on.

Pixel Packing When Video Format Bridge is Not Present

The width of the data port in the `video_out` can be selected from Vivado IDE, under **CSI-2 Options TDATA** width. MIPI CSI-2 RX Subsystem follows the *Recommended Memory Storage* section of the MIPI CSI-2 specifications to output pixels, when a video format bridge is not present.

For more information the data type packing, refer *MIPI Alliance Standard for Camera Serial Interface CSI-2 Specification* [Ref 1].

Example

Pixel mapping for different data types are shown in the following table:

Table 1-4: Pixel Packing for RAW8 Data Type

Bit Position	31	30	29	28	27	26	25	24	23	22	21	20	19	18	17	16	15	14	13	12	11	10	9	8	7	6	5	4	3	2	1	0
RAW8	s7	s6	s5	s4	s3	s2	s1	s0	r7	r6	r5	r4	r3	r2	r1	r0	q7	q6	q5	q4	q3	q2	q1	q0	p7	p6	p5	p4	p3	p2	p1	p0

Notes:

1. p0 to p7 is the 1st pixel bits of RAW8; q0 to q7 is the 2nd pixel bits of RAW8.

Table 1-5: Pixel Packing for RAW10 Data Type

Bit Position	31	30	29	28	27	26	25	24	23	22	21	20	19	18	17	16	15	14	13	12	11	10	9	8	7	6	5	4	3	2	1	0
RAW10	s9	s8	s7	s6	s5	s4	s3	s2	r9	r8	r7	r6	r5	r4	r3	r2	q9	q8	q7	q6	q5	q4	q3	q2	p9	p8	p7	p6	p5	p4	p3	p2
RAW10	v9	v8	v7	v6	v5	v4	v3	v2	u9	u8	u7	u6	u5	u4	u3	u2	t9	t8	t7	t6	t5	t4	t3	t2	s1	s0	r1	r0	q1	q0	p1	p0

Table 1-5: Pixel Packing for RAW10 Data Type

Bit Position	31	30	29	28	27	26	25	24	23	22	21	20	19	18	17	16	15	14	13	12	11	10	9	8	7	6	5	4	3	2	1	0
RAW10	y9	y8	y7	y6	y5	y4	y3	y2	x9	x8	x7	x6	x5	x4	x3	x2	w1	w0	v1	v0	u1	u0	t1	t0	w9	w8	w7	w6	w5	w4	w3	w2

Notes:

1. In RAW10, MSB 8-bits of 4 pixels are transferred first, followed by LSB 2-bits of each pixel.

Table 1-6: Pixel Packing for RGB888 Data Type

Bit Position	31	30	29	28	27	26	25	24	23	22	21	20	19	18	17	16	15	14	13	12	11	10	9	8	7	6	5	4	3	2	1	0
RGB888	d7	d6	d5	d4	d3	d2	d1	d0	c7	c6	c5	c4	c3	c2	c1	c0	b7	b6	b5	b4	b3	b2	b1	b0	a7	a6	a5	a4	a3	a2	a1	a0
RGB888	h7	h6	h5	h4	h3	h2	h1	h0	g7	g6	g5	g4	g3	g2	g1	g0	f7	f6	f5	f4	f3	f2	f1	f0	e7	e6	e5	e4	e3	e2	e1	e0

Notes:

1. In RGB888, a0 to a7 represents the B component, b0 to b7 represents the G component and c0 to c7 represents the R component.

Applications

The Xilinx MIPI CSI-2 RX controller implements a Camera Serial Interface between a camera sensor and a programmable device performing baseband processing. Bandwidth requirement for the camera sensor interface has gone up due to the development of higher resolution cameras. Traditional parallel interfaces require an increasing number of signal lines resulting in higher power consumption. The new high speed serial interfaces, such as MIPI CSI specifications, address these expanding bandwidth requirements without sacrificing power. MIPI is a group of protocols defined by the mobile industry group to standardize all interfaces within mobile platforms such as mobile phones and tablets. However the large volumes and the economies of scale of the mobile industry is forcing other applications to also adopt these standards. As such MIPI-based camera sensors are being increasingly used in applications such as driver assistance technologies in automotive applications, video security surveillance cameras, video conferencing and emerging applications such as virtual and augmented reality.

Unsupported Features

- Some YUV Data Types (YUV 420 (8-bit and 10-bit)) are not supported when the Video Format Bridge is included.
- Dynamic linerate is not supported.
- 8 lanes support is not included.
- Data scramble feature is not supported.

- Latency reduction and transport efficiency features are not supported.

Licensing and Ordering

License Checkers

If the IP requires a license key, the key must be verified. The Vivado® design tools have several license checkpoints for gating licensed IP through the flow. If the license check succeeds, the IP can continue generation. Otherwise, generation halts with error. License checkpoints are enforced by the following tools:

- Vivado synthesis
- Vivado implementation
- write_bitstream (Tcl command)



IMPORTANT: *IP license level is ignored at checkpoints. The test confirms a valid license exists. It does not check IP license level.*

License Type

This Xilinx module is provided under the terms of the [Xilinx Core License Agreement](#). The module is shipped as part of the Vivado® Design Suite. For full access to all core functionalities in simulation and in hardware, you must purchase a license for the core. Contact your [local Xilinx sales representative](#) for information about pricing and availability.

For more information, visit the MIPI CSI-2 RX Subsystem [product web page](#).

Information about other Xilinx LogiCORE IP modules is available at the [Xilinx Intellectual Property](#) page. For information on pricing and availability of other Xilinx LogiCORE IP modules and tools, contact your [local Xilinx sales representative](#).

Product Specification

Standards

- MIPI Alliance Standard for Camera Serial Interface CSI-2 v2.0 [\[Ref 1\]](#)
 - MIPI Alliance Physical Layer Specifications, D-PHY Specification v1.2 [\[Ref 5\]](#)
 - Processor Interface, AXI4-Lite: see the *Vivado Design Suite: AXI Reference Guide* (UG1037) [\[Ref 6\]](#)
 - Output Pixel Interface: see the *AXI4-Stream Video IP and System Design Guide* (UG934) [\[Ref 2\]](#)
-

Performance

This section details the performance information for various core configurations.

Latency

The CSI2 RX Subsystem core latency is the time from the start-of-transmission (SoT) pattern on the serial lines to the tvalid signal assertion at CSI-2 Rx Subsystem output. This includes the D-PHY latency, MIPI RX Controller latency and VFB latency (if Video Format Bridge is included in the Subsystem).

[Figure 2-1](#) represents the latency calculation for the subsystem

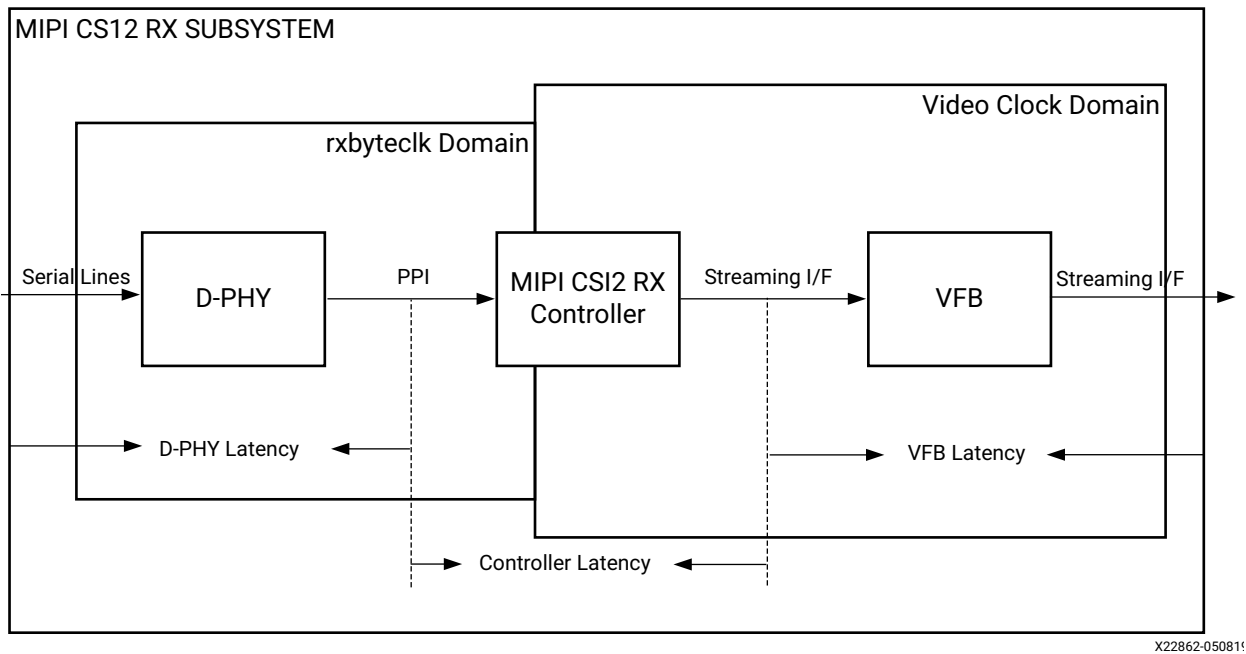

Figure 2-1: MIPI CS12 RX Subsystem Latency Calculation

D-PHY latency:

The MIPI D-PHY RX core latency is the time from the start-of-transmission (SoT) pattern on the serial lines to the activehs signal assertion on the PPI. The HS_SETTLE period contributes significantly in the D-PHY latency calculation.

Table 2-1 provides the latency numbers for various core configurations.

Table 2-1: D-PHY Latency

Data Type	Pixel Mode	Line Rate	Latency in rxbyteclk (HS_SETTLE + internal latency)
RAW20	Single	1000	26(23+3)
RAW8	Single	1000	26(23+3)
RAW8	Dual	1000	26(23+3)
RAW8	Quad	1000	26(23+3)
RAW10	Single	1000	26(23+3)
RAW10	Dual	1200	30(26+4)
RAW10	Quad	800	22(20+2)

Notes: All the calculations are made for a single lane design with a fixed video clock of 148 MHz.

MIPI CSI-2 RX Controller latency:

The MIPI CSI-2 RX Controller core latency is the time from the activehs assertion on the PPI Interface to valid signal assertion on the controller output.

Table 2-2 provides the latency numbers for various core configurations.

Table 2-2: MIPI CSI2 RX Controller latency

Data Type	Pixel Mode	Line Rate	Latency in rxbyteclk	Latency in Video Clock
RAW20	Single	1000	25	60
RAW8	Single	1000	21	49
RAW8	Dual	1000	21	49
RAW8	Quad	1000	21	49
RAW10	Single	1000	25	60
RAW10	Dual	1200	26	63
RAW10	Quad	800	24	56

Notes: All the calculations are made for a single lane design with a fixed video clock of 148 MHz.

Video Format Bridge (VFB) latency:

The VFB core latency is the time time from the VFB input stream interface 'tvalid' to VFB output stream interface 'tvalid'.

Table 2-3 provides the latency numbers for various core configurations.

Table 2-3: VFB latency

Data Type	Pixel Mode	Line Rate	Latency in rxbyteclk	Latency in Video Clock
RAW20	Single	1000	10	24
RAW8	Single	1000	1	3
RAW8	Dual	1000	1	3
RAW8	Quad	1000	1	4
RAW10	Single	1000	2	6
RAW10	Dual	1200	3	6
RAW10	Quad	800	1	3

Notes: All the calculations are made for a fixed video clock of 148 MHz.

Table 2-4 provides the overall latency numbers of MIPI CSI2 RX Subsystem for various core configurations.

Table 2-4: MIPI CSI2 RX Subsystem Latency

Data Type	Pixel Mode	Line Rate	Latency in rxbyteclk
RAW20	Single	1000	61
RAW8	Single	1000	48
RAW8	Dual	1000	48
RAW8	Quad	1000	48
RAW10	Single	1000	53
RAW10	Dual	1200	59
RAW10	Quad	800	47

Notes:

1. All the calculations are made for a single lane design with a fixed video clock of 148 MHz.
2. The latency is improved by increasing the number of lanes.

Resource Utilization

For full details about performance and resource utilization, visit the [Performance and Resource Utilization web page](#).

Port Descriptions

The MIPI CSI-2 RX Subsystem I/O signals are described in Table 2-5.

Table 2-5: Port Descriptions

Signal Name	Direction	Description
lite_aclk	Input	AXI clock
lite_aresetn	Input	AXI reset. Active-Low
S00_AXI*		AXI4-Lite interface, defined in the <i>Vivado Design Suite: AXI Reference Guide</i> (UG1037) [Ref 6]
dphy_clk_200M	Input	Clock for D-PHY core. Must be 200 MHz.
video_aclk	Input	Subsystem clock
video_aresetn ⁽¹⁾	Input	Subsystem reset. Active-Low.
AXI4-Stream Video Interface when Video Format Bridge is Present		
video_out_tvalid	Output	Data valid

Table 2-5: Port Descriptions (Cont'd)

Signal Name	Direction	Description
video_out_tready	Input	Slave ready to accept the data
video_out_tuser[n-1:0]	Output	n is based on TUSER width selected in the Vivado IDE 95-80 CRC ⁽³⁾ 79-72 ECC 71-70 Reserved 69-64 Data Type 63-48 Word Count 47-32 Line Number 31-16 Frame Number 15-2 Reserved 1 Packet Error 0 Start of Frame ⁽²⁾
video_out_tlast	Output	End of line
video_out_tdata[n-1:0]	Output	Data n is based on Data type and number of pixels selected in the Vivado IDE (see video_out Port Width).
video_out_tdest[9:0]	Output	9-4 Data Type 3-0 Virtual Channel Identifier (VC)
AXI4-Stream Interface when Embedded Non-image Interface is Selected		
emb_nonimg_tdata[n-1:0]	output	Data n is based on Data type selected in the Vivado IDE (see Table 1-1).
emb_nonimg_tdest[3:0]	Output	Specifies the Virtual Channel Identifier (VC) value of the embedded non-image packet
emb_nonimg_tkeep[n/8-1:0]	Output	Specifies valid bytes
emb_nonimg_tlast	Output	End of line
emb_nonimg_tready	Input	Slave ready to accept data

Table 2-5: Port Descriptions (Cont'd)

Signal Name	Direction	Description
emb_nonimg_tuser[95:0]	Output	95-80 CRC ⁽³⁾
		79-72 ECC
		71-70 Reserved
		69-64 Data Type
		63-48 Word Count
		47-32 Line Number
		31-16 Frame Number
		15-2 Reserved
		1 Packet Error
		0 Start of frame ⁽²⁾
emb_nonimg_tvalid	Output	Data valid
AXI4-Stream Interface when Video Format Bridge is Not Present		
video_out_tdata[n-1:0]	Output	Data n is based on TDATA width selected in the Vivado IDE.
video_out_tdest[n-1:0]	Output	n is based on TDEST width selected in the Vivado IDE: 9-4 Data type 3-0 Virtual Channel Identifier (VC)
video_out_tkeep[n/8-1:0]	Output	Specifies valid bytes
video_out_tlast	Output	End of line
video_out_tready	Input	Slave ready to accept data
video_out_tuser[n-1:0]	Output	n is based on TUSER width selected in the Vivado IDE
		95-80 CRC ⁽³⁾
		79-72 ECC
		71-70 Reserved
		69-64 Data Type
		63-48 Word Count
		47-32 Line Number
		31-16 Frame Number
		15-2 Reserved
		1 Packet Error
0 Start of frame ⁽²⁾		
video_out_tvalid	Output	Data valid
Other Signals		
csirxss_csi_irq	Output	Interrupt (active-High) from CSI-2 RX Controller
Xilinx 7 series FPGA		

Table 2-5: Port Descriptions (Cont'd)

Signal Name	Direction	Description
mipi_dphy_if	Output	DPHY interface
rxbyteclkhs	Output	PPI high-speed receive byte clock
system_rst_out	Output	Reset indication due to PLL reset (active-High)
dlyctrl_rdy_out	Output	Ready signal output from IDEALYCTRL, stating delay values are adjusted as per vtc changes
clk_300m	Input	300 MHz clock for IDELAYCTRL
UltraScale+ Shared Logic outside Subsystem		
mipi_phy_if	Output	DPHY interface
rxbyteclkhs	Output	PPI high-speed receive byte clock
clkoutphy_out	Output	PHY serial clock
system_rst_out	Output	Reset indication due to PLL reset (active-High)
pll_lock_out	Output	PLL lock indication (active-High)
rxbyteclkhs_cnts_out	Output	Continuous PPI high-speed receive byte clock for line rates > 1500 Mb/s
UltraScale+ Shared logic in the Subsystem		
mipi_phy_if	Output	DPHY interface
bg<x>_pin<y>_nc	Input	Inferred bitslice ports. The core infers bitslice0 of a nibble for strobe propagation within the byte group; <x> indicates byte group (0,1,2,3); <y> indicates bitslice0 position (0 for the lower nibble, 6 for the upper nibble) <ul style="list-style-type: none"> • RTL Design: There is no need to drive any data on these ports. • IP Integrator: These ports must be brought to the top level of the design to properly apply the constraints. Note: Pins are available only for UltraScale+ families.
clkoutphy_in	Input	PHY serial clock
pll_lock_in	Input	PLL Lock indication
rxbyteclkhs	Output	PPI high-speed receive byte clock
rxbyteclkhs_cnts_in	Input	Continuous PPI high-speed receive byte clock for line rates > 1500 Mb/s
CSI-2 Controller Register Interface Disabled		
ctrl_core_en	Input	Enable the core to receive and process packets
ctrl_dis_in_prgs	Output	Indicates the CSI-2 RX Controller core disable is in progress
errsotsynchs_intr	Output	Interrupt output indicating SoT synchronization completely failed
errsoths_intr	Output	Interrupt output indicating SoT error detected
cl_stopstate_intr	Output	High when clock lane is currently in stop state
dl<n>_stopstate_intr	Output	High when the lane module is currently in stop state

Table 2-5: Port Descriptions (Cont'd)

Signal Name	Direction	Description
crc_status_intr	Output	High when the computed CRC code is different from the received CRC code
ecc_status_intr[1:0]	Output	Bit 1- High when ECC syndrome is computed and two bits error is detected in the recieved packet header
		Bit 0- High when ECC syndrome was computed and a single bit error in the packet header was detected and corrected
linebuffer_full	Output	High when line buffer is full
frame_rcvd_pulse_out	Output	High when the Frame End (FE) short packet is received for the current frame

Notes:

1. The active-High reset for the MIPI D-PHY core is generated internally by setting the external active-Low reset (`video_aresetn`) to 0.
2. Each frame start packet with Virtual Channel (VC) identifier will be mapped to the first image packet and the first embedded non-image with the corresponding VC.
3. As CRC appears at the end of the MIPI packet, ECC and CRC are reported ONLY during the last beat of the stream transfer when TLAST and TVALID are asserted. You need to ignore ECC/CRC reported during other beats of the transfer. See [Interface Debug](#) for more details.

Register Space

This section details registers available in the MIPI CSI-2 RX Subsystem. The address map is split into following regions:

- MIPI CSI-2 RX Controller core
- MIPI D-PHY core

Each IP core is given an address space of 64K. Example offset addresses from the system base address when the MIPI D-PHY registers are enabled are shown in [Table 2-6](#).

Table 2-6: Sub-Core Address Offsets

IP Cores	Offset
MIPI CSI-2 RX Controller	0x0_0000
MIPI D-PHY	0x1_0000

MIPI CSI-2 RX Controller Core Registers

Table 2-7 specifies the name, address, and description of each firmware addressable register within the MIPI CSI-2 RX controller core.

Table 2-7: MIPI CSI-2 RX Controller Core Registers

Address Offset	Register Name	Description
0x00	Core Configuration Register	Core configuration options
0x04	Protocol Configuration Register	Protocol configuration options
0x08	Reserved ⁽¹⁾	
0x0C	Reserved	
0x10	Core Status Register	Internal status of the core
0x14	Reserved	
0x18	Reserved	
0x1C	Reserved	
0x20	Global Interrupt Enable Register	Global interrupt enable registers
0x24	Interrupt Status Register	Interrupt status register
0x28	Interrupt Enable Register	Interrupt enable register
0x2C	Reserved	
0x30	Generic Short Packet Register	Short packet data
0x34	VCX Frame Error Register	VCX Frame Error Register
0x38	Reserved	
0x3C	Clock Lane Information Register	Clock lane status information
Lane<n> Information Registers		
0x40	Lane0 Information	Lane 0 status information
0x44	Lane1 Information	Lane 1 status information
0x48	Lane2 Information	Lane 2 status information
0x4C	Lane3 Information	Lane 3 status information
0x50	Reserved	
0x54	Reserved	
0x58	Reserved	
0x5C	Reserved	
Image Information 1 Registers (VC0 to VC15) and Image Information 2 Registers (VC0 to VC15)		
0x60	Image Information 1 for VC0	Image information 1 of the current processing packet with VC of 0

Table 2-7: MIPI CSI-2 RX Controller Core Registers (Cont'd)

Address Offset	Register Name	Description
0x64	Image Information 2 for VC0	Image information 2 of the current processing packet with VC of 0
0x68	Image Information 1 for VC1	Image information 1 of the current processing packet with VC of 1
0x6C	Image Information 2 for VC1	Image information 2 of the current processing packet with VC of 1
0x70	Image Information 1 for VC2	Image information 1 of the current processing packet with VC of 2
0x74	Image Information 2 for VC2	Image information 2 of the current processing packet with VC of 2
0x78	Image Information 1 for VC3	Image information 1 of the current processing packet with VC of 3
0x7C	Image Information 2 for VC3	Image information 2 of the current processing packet with VC of 3
0x80	Image Information 1 for VC4	Image information 1 of the current processing packet with VC of 4
0x84	Image Information 2 for VC4	Image information 2 of the current processing packet with VC of 4
0x88	Image Information 1 for VC5	Image information 1 of the current processing packet with VC of 5
0x8C	Image Information 2 for VC5	Image information 2 of the current processing packet with VC of 5
0x90	Image Information 1 for VC6	Image information 1 of the current processing packet with VC of 6
0x94	Image Information 2 for VC6	Image information 2 of the current processing packet with VC of 6
0x98	Image Information 1 for VC7	Image information 1 of the current processing packet with VC of 7
0x9C	Image Information 2 for VC7	Image information 2 of the current processing packet with VC of 7
0xA0	Image Information 1 for VC8	Image information 1 of the current processing packet with VC of 8
0xA4	Image Information 2 for VC8	Image information 2 of the current processing packet with VC of 8
0xA8	Image Information 1 for VC9	Image information 1 of the current processing packet with VC of 9
0xAC	Image Information 2 for VC9	Image information 2 of the current processing packet with VC of 9
0xB0	Image Information 1 for VC10	Image information 1 of the current processing packet with VC of 10
0xB4	Image Information 2 for VC10	Image information 2 of the current processing packet with VC of 10

Table 2-7: MIPI CSI-2 RX Controller Core Registers (Cont'd)

Address Offset	Register Name	Description
0xB8	Image Information 1 for VC11	Image information 1 of the current processing packet with VC of 11
0xBC	Image Information 2 for VC11	Image information 2 of the current processing packet with VC of 11
0xC0	Image Information 1 for VC12	Image information 1 of the current processing packet with VC of 12
0xC4	Image Information 2 for VC12	Image information 2 of the current processing packet with VC of 12
0xC8	Image Information 1 for VC13	Image information 1 of the current processing packet with VC of 13
0xCC	Image Information 2 for VC13	Image information 2 of the current processing packet with VC of 13
0xD0	Image Information 1 for VC14	Image information 1 of the current processing packet with VC of 14
0xD4	Image Information 2 for VC14	Image information 2 of the current processing packet with VC of 14
0xD8	Image Information 1 for VC15	Image information 1 of the current processing packet with VC of 15
0xDC	Image Information 2 for VC15	Image information 2 of the current processing packet with VC of 15

Notes:

1. Access type and reset value for all the reserved bits in the registers is read-only with value 0.
2. Register accesses should be word aligned and there is no support for a write strobe. WSTRB is not used internally.
3. Only the lower 7-bits (6:0) of the read and write address of the AXI4-Lite interface are decoded. This means that accessing address 0x00 and 0x80 results in reading the same address of 0x00.
4. Reads and writes to addresses outside this table do not return an error.

Core Configuration Register

The Core Configuration register is described in [Table 2-8](#) and allows you to enable and disable the MIPI CSI-2 RX Controller core and apply a soft reset during core operation.

Table 2-8: Core Configuration Register (0x00)

Bits	Name	Reset Value	Access	Description
31–2	Reserved	N/A	N/A	Reserved
1	Soft Reset	0x0	R/W	1: Resets the core 0: Takes core out of soft reset All registers reset to their default value (except for this bit, Core Enable and Active lanes configuration). In addition to resetting registers when this bit is set to 1: <ul style="list-style-type: none"> • Shut down port is not asserted on the PPI lanes • Internal FIFOs (PPI, Packet, Generic Short Packet) are flushed • Control Finite State Machine (FSM) stops processing current packet. Any partially written packet to memory is marked as errored. This packet, when made available through the AXI4-Stream interface, reports the error on TUSER[1].
0	Core Enable	0x1	R/W	1: Enables the core to receive and process packets 0: Disables the core for operation When disabled: <ul style="list-style-type: none"> • Shuts down port assertion on the PPI lanes • Internal FIFOs (PPI, Packet, Generic Short Packet) are flushed • Control FSM stops processing current packet Any partially written packet to memory is marked as errored. This packet, when made available through the AXI4-Stream interface, reports the error on TUSER[1].

Notes:

1. The short packet and line buffer FIFO full conditions take a few clocks to reflect in the register clock domain from the core clock domain due to Clock Domain Crossing (CDC) blocks.

Protocol Configuration Register

The Protocol Configuration register is described in [Table 2-9](#) and allows you to configure protocol specific options such as the number of lanes to be used.

Table 2-9: Protocol Configuration Register (0x04)

Bits	Name	Reset Value	Access	Description
31–5	Reserved	N/A	N/A	Reserved
4–3	Maximum Lanes ⁽¹⁾	Number of lanes configured during core generation	R	Maximum lanes of the core 0x0—1 Lane 0x1—2 Lanes 0x2—3 Lanes 0x3—4 Lanes
2	Reserved	N/A		Reserved
1–0	Active Lanes	Number of lanes configured during core generation	R ⁽²⁾ /W	Active lanes in the core ⁽³⁾ 0x0—1 Lane 0x1—2 Lanes 0x2—3 Lanes 0x3—4 Lanes

Notes:

1. Maximum Lanes cannot exceed the number of lanes as set by the **Serial Data Lanes** parameter at generation time.
2. A read from this register reflects the current number of lanes being used by core. This is useful when dynamically updating the active lanes during core operation to ensure that the core is using the new active lanes information. See [Chapter 3, Designing with the Subsystem](#) for more information.
3. Active Lanes cannot exceed the Maximum Lanes as set in the Protocol Configuration register setting of bits 4–3.

Core Status Register

The Core Status register is described in [Table 2-10](#).

Table 2-10: Core Status Register (0x10)

Bits	Name	Reset Value	Access	Description
31–16	Packet Count	0x0	R	Counts number of long packets written to the line buffer • No roll-over of this counter reported/ supported • Count includes error packets (if any)
15–4	Reserved	N/A	N/A	N/A
3	Short packet FIFO Full	0x0	R	Indicates the current status of short packet FIFO full condition
2	Short packet FIFO not empty	0x0	R	FIFO not empty: Indicates the current status of short packet FIFO not empty condition

Table 2-10: Core Status Register (0x10) (Cont'd)

Bits	Name	Reset Value	Access	Description
1	Stream Line buffer Full	0x0	R	Indicates the current status of line buffer full condition
0	Soft reset/Core disable in progress	0x0	R	Set to 1 by the core to indicate that internal soft reset/core disable activities are in progress

Global Interrupt Enable Register

The Global Interrupt Enable register is described in [Table 2-11](#).

Table 2-11: Global Interrupt Enable Register (0x20)

Bits	Name	Reset Value	Access	Description
31–1	Reserved	N/A	N/A	Reserved
0	Global Interrupt enable	0x0	R/W	Master enable for the device interrupt output to the system 1: Enabled—the corresponding Interrupt Enable register (IER) bits are used to generate interrupts 0: Disabled—Interrupt generation blocked irrespective of IER bits

Interrupt Status Register

The Interrupt Status register (ISR) is described in [Table 2-12](#) and captures the error and status information for the core.

Table 2-12: Interrupt Status Register (0x24)

Bits	Name	Reset Value	Access ⁽¹⁾	Description
31	Frame Received	0x0	R/W1C	Asserted when the Frame End (FE) short packet is received for the current frame
30	VCX Frame Error	RO	0x0	Asserted when the VCX Frame error is detected
29	RX_Skewcalhs	0x0	R/W1C	Asserted when rxskewcalhs is detected.
28–23	Reserved	N/A	N/A	N/A

Table 2-12: Interrupt Status Register (0x24) (Cont'd)

Bits	Name	Reset Value	Access ⁽¹⁾	Description
22	Word Count (WC) corruption	0x0	R/W1C	Asserted when WC field of packet header corrupted and core receives less bytes than indicated in WC field. Such a case can occur only where more than 2-bits of header are corrupted which ECC algorithm cannot report and the corruption is such that the ECC algorithm reports a higher Word Count (WC) value as part of ECC correction. In such case core limits processing of the packet on reduced number of bytes received through PPI interface.
21	Incorrect lane configuration	0x0	R/W1C	Asserted when Active lanes is greater than Maximum lanes in the protocol configuration register
20	Short packet FIFO full	0x0	R/W1C	Active-High signal asserted when the short packet FIFO full condition detected
19	Short packet FIFO not empty	0x0	R/W1C	Active-High signal asserted when short packet FIFO not empty condition detected
18	Stream line buffer full	0x0	R/W1C	Asserts when the line buffer is full ⁽²⁾
17	Stop state	0x0	R/W1C	Active-High signal indicates that the lane module is currently in Stop state ⁽³⁾
16	Reserved	N/A	N/A	N/A
15	Reserved	N/A	N/A	N/A
14	Reserved	N/A	N/A	N/A
13	SoT error (ErrSoTHS)	0x0	R/W1C	Indicates Start-of-Transmission (SoT) error detected ⁽³⁾
12	SoT sync error (ErrSotSyncHS)	0x0	R/W1C	Indicates SoT synchronization completely failed ⁽³⁾
11	ECC 2-bit error (ErrEccDouble)	0x0	R/W1C	Asserted when an ECC syndrome is computed and two bit errors detected in the received packet header
10	ECC 1-bit error (Detected and Corrected) (ErrEccCorrected)	0x0	R/W1C	Asserted when an ECC syndrome was computed and a single bit error in the packet header was detected and corrected
9	CRC error (ErrCrc)	0x0	R/W1C	Asserted when the computed CRC code is different from the received CRC code
8	Unsupported Data Type (ErrID)	0x0	R/W1C	Asserted when a packet header is decoded with an unrecognized or not implemented data ID
7	Frame synchronization error for VC3 (ErrFrameSync)	0x0	R/W1C	Asserted when an FE is not paired with a Frame Start (FS) on the same virtual channel ⁽⁴⁾

Table 2-12: Interrupt Status Register (0x24) (Cont'd)

Bits	Name	Reset Value	Access ⁽¹⁾	Description
6	Frame level error for VC3 (ErrFrameData)	0x0	R/W1C	Asserted after an FE when the data payload received between FS and FE contains errors. The data payload errors are CRC errors.
5	Frame synchronization error for VC2 (ErrFrameSync)	0x0	R/W1C	Asserted when an FE is not paired with a FS on the same virtual channel ⁽⁴⁾
4	Frame level error for VC2 (ErrFrameData)	0x0	R/W1C	Asserted after an FE when the data payload received between FS and FE contains errors. The data payload errors are CRC errors.
3	Frame synchronization error for VC1 (ErrFrameSync)	0x0	R/W1C	Asserted when an FE is not paired with a FS on the same virtual channel ⁽⁴⁾
2	Frame level error for VC1 (ErrFrameData)	0x0	R/W1C	Asserted after an FE when the data payload received between FS and FE contains errors. The data payload errors are CRC errors.
1	Frame synchronization error for VC0 (ErrFrameSync)	0x0	R/W1C	Asserted when a FE is not paired with a FS on the same virtual channel ⁽⁴⁾
0	Frame level error for VC0 (ErrFrameData)	0x0	R/W1C	Asserted after an FE when the data payload received between FS and FE contains errors. The data payload errors are CRC errors.

Notes:

1. W1C = Write 1 to clear.
2. In a line buffer full condition, reset the core using the external reset, video_aresetn.
3. Reported through the PPI.
4. An ErrSotSynchs error also generates this error signal.
5. Short packet and line buffer FIFO full conditions take a few clock periods to reflect in the register clock domain from the core clock domain due to Clock Domain Crossing (CDC) blocks.
6. All PPI signals captured in the ISR take a few clock periods to reflect in the register clock domain from the PPI clock domain due to CDC blocks.
7. Frame level errors due to ErrSotSynchs are mapped to the recent VC processed by the ECC block of the core.
8. Set conditions take priority over the reset conditions for the ISR bits.
9. Signal names in brackets are defined in the *MIPI Alliance Standard for Camera Serial Interface CSI-2* [Ref 1].

Tables 2-13 to 2-24 provide detailed information about the bits in Table 2-12.

Table 2-13: Incorrect Lane Configuration

Set Condition(s)	Set by the core when incorrect lane configuration is programmed. Ex: Maximum available lanes =2 and "Active lanes" configured as 3
Reset Sequence	Write 1 to clear this bit.
Priority	Set condition takes priority over reset sequence.
Impact	This is a core configuration error and the core cannot function as desired. This error should be corrected before proceeding further.

Table 2-14: Stream Line Buffer Full

Set Condition(s)	Set by the core when the line buffer storing pixel data is full.
Reset Sequence	Write 1 to clear this bit.
Priority	Set condition takes priority over reset sequence.
Impact	Core reports this condition on stream interface using an error indication on the TUSER[1] port if a partial packet is being written to line buffer. Because PPI does not allow back pressure, you need to ensure that this condition does not occur.

Table 2-15: Control Error, Escape Entry Error, Escape Ultra Low Power Mode, Stopstate

Set Condition(s)	Set by the core when the condition for the corresponding signal as defined in the MIPI CSI-2 specification [Ref 1] is seen, reported through the PPI interface.
Reset Sequence	Write 1 to clear this bit.
Priority	Set condition takes priority over reset sequence.
Impact	Current packet being processed does not have any impact.

Table 2-16: SoT Error

Set Condition(s)	Set by the core when the current packet being processed has Start-of-Transmission (SoT) Error reported through PPI Interface.
Reset Sequence	Write 1 to clear this bit.
Priority	Set condition takes priority over reset sequence.
Impact	Current packet under process does not have any impact as synchronization is still achieved. This is considered to be a “soft error” in the leader sequence and confidence in the payload data is reduced.

Table 2-17: SoT Sync Error

Set Condition(s)	Set by the core when current packet being processed has Start-of-Transmission Synchronization Error reported through PPI interface.
Reset Sequence	Write 1 to clear this bit.
Priority	Set condition takes priority over reset sequence.
Impact	The current packet being processed is not processed further. The core waits for the next packet to process.

Table 2-18: ECC 2-Bit Error

Set Condition(s)	Set by the core when an ECC syndrome was computed and two bit-errors are detected in the received Packet Header.
Reset Sequence	Write 1 to clear this bit.
Priority	Set condition takes priority over reset sequence.
Impact	Current packet being processed is not processed further as WC is not usable, and thus the packet end cannot be estimated. The core waits for the next packet to process.

Table 2-19: ECC 1-Bit Error

Set Condition(s)	Set by the core when an ECC syndrome was computed and a single bit-error in the Packet Header was detected and corrected.
Reset Sequence	Write 1 to clear this bit.
Priority	Set condition takes priority over reset sequence.
Impact	Current packet being processed does not have any impact.

Table 2-20: CRC Error

Set Condition(s)	Set by the core when the computed CRC code is different than the received CRC code.
Reset Sequence	Write 1 to clear this bit.
Priority	Set condition takes priority over reset sequence.
Impact	Current packet being processed does not have any impact, but the payload might be corrupted.

Table 2-21: Unsupported Data Type

Set Condition(s)	Set by the core when a Packet Header is decoded with an unrecognized or un-implemented data ID.
Reset Sequence	Write 1 to clear this bit.
Priority	Set condition takes priority over reset sequence.
Impact	Current packet being processed is not processed further. The core waits for the next packet to process.

Table 2-22: Frame Synchronization Error

Set Condition(s)	Set by the core when a Frame End (FE) is not paired with a Frame Start (FS) on the same virtual channel. An <code>ErrSotSyncHS</code> should also generate this error signal.
Reset Sequence	Write 1 to clear this bit.
Priority	Set condition takes priority over reset sequence.
Impact	Based on the different sources for this error packet might or might not be processed (that is, stored in the line buffer).

Table 2-23: ErrFrameSync Sources

Source	Impact on Packet Processing
FS followed by FS	Processed
ErrEccDouble	Not processed
FE followed FE	Processed
ErrSotSyncHS	Not processed

VC Mapping

In the event of an `ErrEccDouble` error, the VC is mapped to the VC reported in the current packet header (even if corrupted).

In the event of an ErrSotSyncHS error, the VC is mapped to the previous VC processed because in this case the packet header is not available.

Table 2-24: Frame Level Error

Set Condition(s)	Set by the core after an FE when the data payload received between FS and FE contains errors.
Reset Sequence	Write 1 to clear this bit.
Priority	Set condition takes priority over reset sequence.
Impact	Current packet being processed does not have any impact but the payload might be corrupted.

Interrupt Enable Register

The Interrupt Enable register (IER) is described in [Table 2-25](#) and allows you to selectively generate an interrupt at the output port for each error/status bit in the ISR. An IER bit set to 0 does not inhibit an error/status condition from being captured, but inhibits it from generating an interrupt.

Table 2-25: Interrupt Enable Register (0x28)

Bits	Name	Reset Value	Access	Description
31	Frame Received	0x0	R/W	Set bits in this register to 1 to generate the required interrupts. Set to 0 to disable the interrupt. For a description of the specific interrupt you are enabling/disabling in this register see the ISR descriptions in Table 2-12 .
29	RX_Skewcalhs	0x0	R/W	Set to 1 when rxskecalhs interrupt needs to be generated

Table 2-25: Interrupt Enable Register (0x28) (Cont'd)

Bits	Name	Reset Value	Access	Description
28–23	Reserved	N/A	N/A	Set bits in this register to 1 to generate the required interrupts. Set to 0 to disable the interrupt. For a description of the specific interrupt you are enabling/disabling in this register see the ISR descriptions in Table 2-12 .
22	Word Count (WC) corruption	0x0	R/W	
21	Incorrect lane configuration	0x0	R/W	
20	Short packet FIFO full	0x0	R/W	
19	Short packet FIFO empty	0x0	R/W	
18	Stream line buffer full	0x0	R/W	
17	Stop state	0x0	R/W	
16	Reserved	N/A	N/A	
15	Reserved	N/A	N/A	
14	Reserved	N/A	N/A	
13	SoT error	0x0	R/W	
12	SoT Sync error	0x0	R/W	
11	ECC 2-bit error	0x0	R/W	
10	ECC 1-bit error (Detected and Corrected)	0x0	R/W	
9	CRC error	0x0	R/W	
8	Unsupported Data Type	0x0	R/W	
7	Frame synchronization error for VC3	0x0	R/W	
6	Frame level error for VC3	0x0	R/W	
5	Frame synchronization error for VC2	0x0	R/W	
4	Frame level error for VC2	0x0	R/W	
3	Frame synchronization error for VC1	0x0	R/W	
2	Frame level error for VC1	0x0	R/W	
1	Frame synchronization error for VC0	0x0	R/W	
0	Frame level error for VC0	0x0	R/W	

Generic Short Packet Register

The Generic Short Packet register is described in [Table 2-26](#). Packets received with generic short packet codes are stored in a 31-deep internal FIFO and are made available through this register. The following conditions reset the FIFO:

- External reset on `video_aresetn`
- Core disable or soft reset through register settings.

Table 2-26: Generic Short Packet Register (0x30)

Bits	Name	Reset Value	Access	Description
31–24	Reserved	N/A	N/A	Reserved
23–8	Data	0x0	R	16-bit short packet data
7–6	Virtual Channel	0x0	R	Virtual channel number
5–0	Data Type	0x0	R	Generic short packet code

VCX Frame Error Register

The VCX Frame Error register is described in [Table 2-27](#). It captures the frame level and frame synchronization errors for the VC extension channels.

Table 2-27: VCX Frame Error (0x34)

Bits	Name	Access	Default Value	Description
31–24	Reserved	N/A	N/A	Reserved
23	Frame synchronization error for VC15	R/W1C	0x0	Asserted when an FE is not paired with a Frame Start (FS) on the same virtual channel.
22	Frame level error for VC15	R/W1C	0x0	Asserted after an FE when the data payload received between FS and FE contains errors. The data payload errors are CRC errors.
21	Frame synchronization error for VC14	R/W1C	0x0	Asserted when an FE is not paired with a Frame Start (FS) on the same virtual channel.
20	Frame level error for VC14	R/W1C	0x0	Asserted after an FE when the data payload received between FS and FE contains errors. The data payload errors are CRC errors.
19	Frame synchronization error for VC13	R/W1C	0x0	Asserted when an FE is not paired with a Frame Start (FS) on the same virtual channel.
18	Frame level error for VC13	R/W1C	0x0	Asserted after an FE when the data payload received between FS and FE contains errors. The data payload errors are CRC errors.

Table 2-27: VCX Frame Error (0x34) (Cont'd)

Bits	Name	Access	Default Value	Description
17	Frame synchronization error for VC12	R/W1C	0x0	Asserted when an FE is not paired with a Frame Start (FS) on the same virtual channel.
16	Frame level error for VC12	R/W1C	0x0	Asserted after an FE when the data payload received between FS and FE contains errors. The data payload errors are CRC errors.
15	Frame synchronization error for VC11	R/W1C	0x0	Asserted when an FE is not paired with a Frame Start (FS) on the same virtual channel.
14	Frame level error for VC11	R/W1C	0x0	Asserted after an FE when the data payload received between FS and FE contains errors. The data payload errors are CRC errors.
13	Frame synchronization error for VC10	R/W1C	0x0	Asserted when an FE is not paired with a Frame Start (FS) on the same virtual channel.
12	Frame level error for VC10	R/W1C	0x0	Asserted after an FE when the data payload received between FS and FE contains errors. The data payload errors are CRC errors.
11	Frame synchronization error for VC9	R/W1C	0x0	Asserted when an FE is not paired with a Frame Start (FS) on the same virtual channel.
10	Frame level error for VC9	R/W1C	0x0	Asserted after an FE when the data payload received between FS and FE contains errors. The data payload errors are CRC errors.
9	Frame synchronization error for VC8	R/W1C	0x0	Asserted when an FE is not paired with a Frame Start (FS) on the same virtual channel.
8	Frame level error for VC8	R/W1C	0x0	Asserted after an FE when the data payload received between FS and FE contains errors. The data payload errors are CRC errors.
7	Frame synchronization error for VC7	R/W1C	0x0	Asserted when an FE is not paired with a Frame Start (FS) on the same virtual channel.
6	Frame level error for VC7	R/W1C	0x0	Asserted after an FE when the data payload received between FS and FE contains errors. The data payload errors are CRC errors.
5	Frame synchronization error for VC6	R/W1C	0x0	Asserted when an FE is not paired with a Frame Start (FS) on the same virtual channel.
4	Frame level error for VC6	R/W1C	0x0	Asserted after an FE when the data payload received between FS and FE contains errors. The data payload errors are CRC errors.

Table 2-27: VCX Frame Error (0x34) (Cont'd)

Bits	Name	Access	Default Value	Description
3	Frame synchronization error for VC5	R/W1C	0x0	Asserted when an FE is not paired with a Frame Start (FS) on the same virtual channel.
2	Frame level error for VC5	R/W1C	0x0	Asserted after an FE when the data payload received between FS and FE contains errors. The data payload errors are CRC errors.
1	Frame synchronization error for VC4	R/W1C	0x0	Asserted when an FE is not paired with a Frame Start (FS) on the same virtual channel.
0	Frame level error for VC4	R/W1C	0x0	Asserted after an FE when the data payload received between FS and FE contains errors. The data payload errors are CRC errors.

Clock Lane Information Register

The Clock Lane Information register is described in [Table 2-28](#). The Stop state is captured in this register.

Table 2-28: Clock Lane Information Register (0x3C)

Bits	Name	Reset Value	Access	Description
31–2	Reserved	N/A	N/A	Reserved
1	Stop state	0x0	R	Stop state on clock lane
0	Reserved	N/A	N/A	Reserved

Lane<n> Information Registers

The Lane<n> Information register, where n is 0, 1, 2 or 3, is described in [Table 2-29](#) and provides the status of the <n> data lane. This register is reset when any write to the Protocol Configuration register is detected, irrespective of whether the Protocol Configuration register contents are updated or not.

Table 2-29: Lane 0, 1, 2, 3 Information Register (0x40, 0x44, 0x48, 0x4C)

Bits	Name	Reset Value	Access	Description ⁽²⁾
31–6	Reserved	N/A	N/A	Reserved
5	Stop state	0x0	RO	Detection of stop state
4	Reserved	N/A	N/A	Reserved
3	Reserved	N/A	N/A	Reserved
2	skewcalhs	0x0	R	Indicates the deskew reception
1	SoT error	0x0	R	Detection of SoT Error

Table 2-29: Lane 0, 1, 2, 3 Information Register (0x40, 0x44, 0x48, 0x4C) (Cont'd)

Bits	Name	Reset Value	Access	Description ⁽²⁾
0	SoT Sync error	0x0	R	Detection of SoT Synchronization Error

Notes:

1. Lane Information registers are present only for the maximum defined number of lanes. Reads to others registers gives 0x0.
2. All bits are reported through the PPI.

Image Information 1 Registers (VC0 to VC15)

The Image Information 1 registers are described in [Table 2-30](#) and provide image information for line count and byte count per VC. The byte count gets updated whenever a long packet (from Data Types 0x18 and above) for the corresponding virtual channel is processed by the control FSM. The line count is updated whenever the packet is written into the line buffer.

Table 2-30: Image Information 1 Registers (0x60, 0x68, 0x70, 0x78)

Bits	Name	Reset Value	Access	Description
31–16	Line count	0x0	R	Number of long packets written to line buffer
15–0	Byte count	0x0	R	Byte count of current packet being processed by the control FSM

Image Information 2 Registers (VC0 to VC15)

The Image Information 2 registers are described in [Table 2-31](#) and provide the image information Data Type. The Data Type is updated whenever a long packet (Data Types 0x18 and above) for the corresponding virtual channel is processed by the control FSM.

Table 2-31: Image Information 2 Registers (0x64, 0x6C, 0x74, 0x7C)

Bits	Name	Reset Value	Access	Description
31–6	Reserved	N/A	N/A	Reserved
5–0	Data Type	0x0	R	Data Type of current packet being processed by control FSM

MIPI D-PHY Registers

The MIPI D-PHY registers are available when **D-PHY Register Interface** is selected in Vivado IDE. For details about MIPI D-PHY registers, see the *MIPI D-PHY LogiCORE IP Product Guide* (PG202) [\[Ref 3\]](#).

Designing with the Subsystem

This chapter includes guidelines and additional information to facilitate designing with the subsystem.

General Design Guidelines

The subsystem fits into a image sensor pipe receive path. The input to the subsystem must be connected to an image source such as an image sensor transmitting data that adheres to the MIPI protocol. The output of the subsystem is image data in AXI4-Stream format. Based on the throughput requirement the output interface can be tuned using customization parameters available for the subsystem.

Because the MIPI protocol does not allow throttling on the input interface, the module connected to the output of this subsystem should have sufficient bandwidth for the data generated by the image sensor.

The Protocol Configuration Register [1:0] can be used to dynamically configure the active lanes used by the subsystem using the following guidelines:

1. Program the required lanes in the Protocol Configuration register (only allowed when "Enable Active Lanes" is set in the Vivado IDE).
2. The subsystem internally updates the new lanes information after the current packet complete indication is seen (that is, when the current active lanes indicate a Stop state condition) and a subsequent RxByteClkHS signal is seen on the PPI.
3. A read from the Protocol Configuration register reflects the new value after the subsystem has successfully updated the new lanes information internally.
4. Do not send the new updated lanes traffic until the read from Protocol Configuration registers reflects the new value.

Shared Logic

Shared Logic provides a flexible architecture that works both as a stand-alone subsystem and as part of a larger design with one of more subsystem instances. This minimizes the

amount of HDL modifications required, but at the same time retains the flexibility of the subsystem.

Shared logic in the CSI-2 RX Subsystem allows you to share PLLs with multiple instances of the CSI-2 RX Subsystem within the same I/O bank.

There is a level of hierarchy called <component_name>_support. Figure 3-1 and Figure 3-2 show two hierarchies where the shared logic is either contained in the subsystem or in the example design. In these figures, <component_name> is the name of the generated subsystem. The difference between the two hierarchies is the boundary of the subsystem. It is controlled using the Shared Logic option in the Vivado IDE Shared Logic tab for the MIPI CSI-2 RX Subsystem. The shared logic comprises a PLL and some BUFs (maximum of 4).

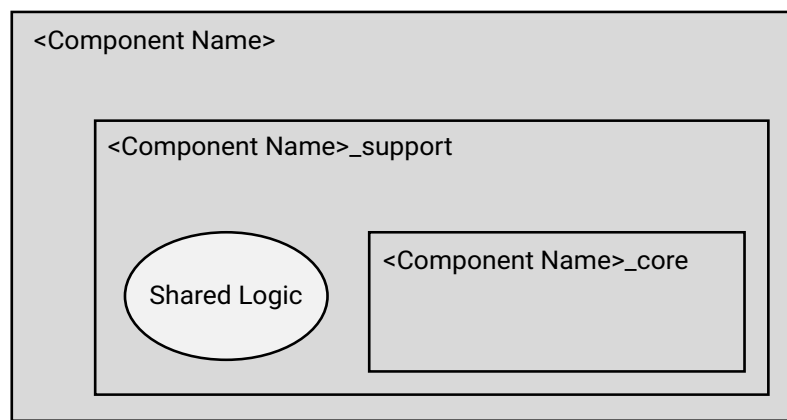

X16320-030816

Figure 3-1: Shared Logic Included in the Subsystem

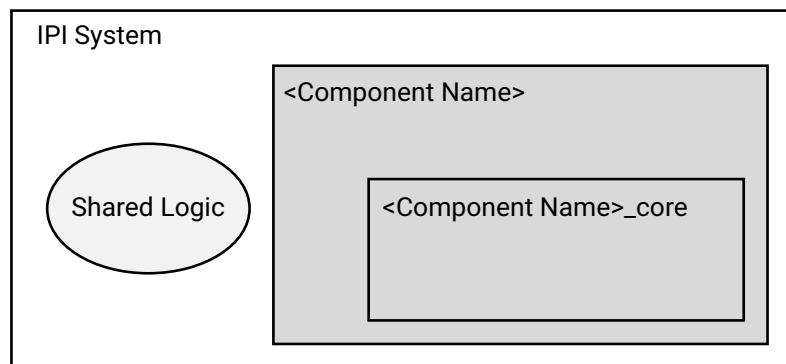

X16321-033116

Figure 3-2: Shared Logic Outside the Subsystem

Shared Logic in the Subsystem

Selecting **Shared Logic in the Core** implements the subsystem with the PLL inside the subsystem to generate all the clocking requirement of the PHY layer.

Select **Include Shared Logic in Core** if:

- You do not require direct control over the PLL generated clocks
- You want to manage multiple customizations of the subsystem for multi-subsystem designs
- This is the first MIPI CSI-2 RX Subsystem in a multi-subsystem system

These components are included in the subsystem, and their output ports are also provided as subsystem outputs.

Shared Logic Outside Subsystem

The PLLs are outside this subsystem instance.

Select **Include Shared Logic in example design** if:

- This is not the first MIPI CSI-2 RX Subsystem instance in a multi-subsystem design that shares PLLs generated from other MIPI CSI-2 RX Subsystem that is configured with shared logic in the Core mode.

To fully utilize the PLL, customize one MIPI CSI-2 RX Subsystem with shared logic in the subsystem and one with shared logic in the example design. You can connect the PLL outputs from the first MIPI CSI-2 RX Subsystem to the second subsystem.

There should be at least one MIPI CSI-2 RX Subsystem with 'include shared Logic in the Core' mode whose outputs for shared resources can be used in other MIPI CSI-2 RX Subsystem generated with 'include shared logic in example design' mode.

[Figure 3-3](#) shows the sharable resource connections from the MIPI CSI-2 RX Subsystem with shared logic included (MIPI_CSI_SS_Master) to the instance of another MIPI CSI-2 RX Subsystem without shared logic (MIPI_CSI_SS_Slave00 and MIPI_CSI_SS_Slave01) for UltraScale+ devices.

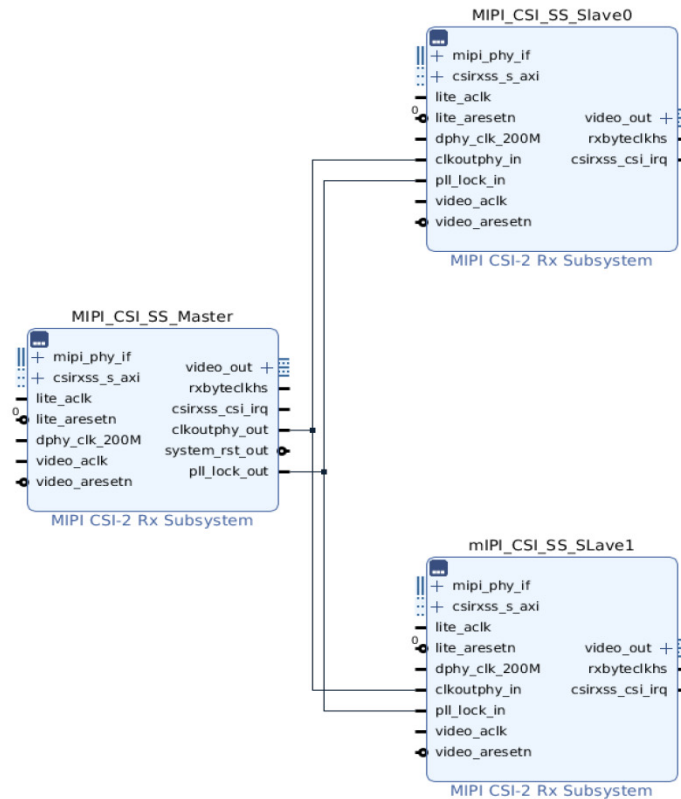

Figure 3-3: Shared Logic in the Example Design

Note: The master and slave cores can be configured with the different line rates when operating <1.5 Gb/s. However, when operating >1.5 Gb/s with Deskew detection feature enabled, the master and slave cores should be configured with the same line rate when sharing `clkoutphy` within IO bank. There must be at least one core with master mode in a system whose clocks can be shared with slave mode cores.



IMPORTANT: Initialize all MIPI interfaces in the same HP IO Bank at the same time. For example, multiple CSI-2 or D-PHY instances in a system. For more information on implementing multiple interfaces in the same HP IO Bank, see *UltraScale Architecture SelectIO Resources (UG571)* [Ref 15].

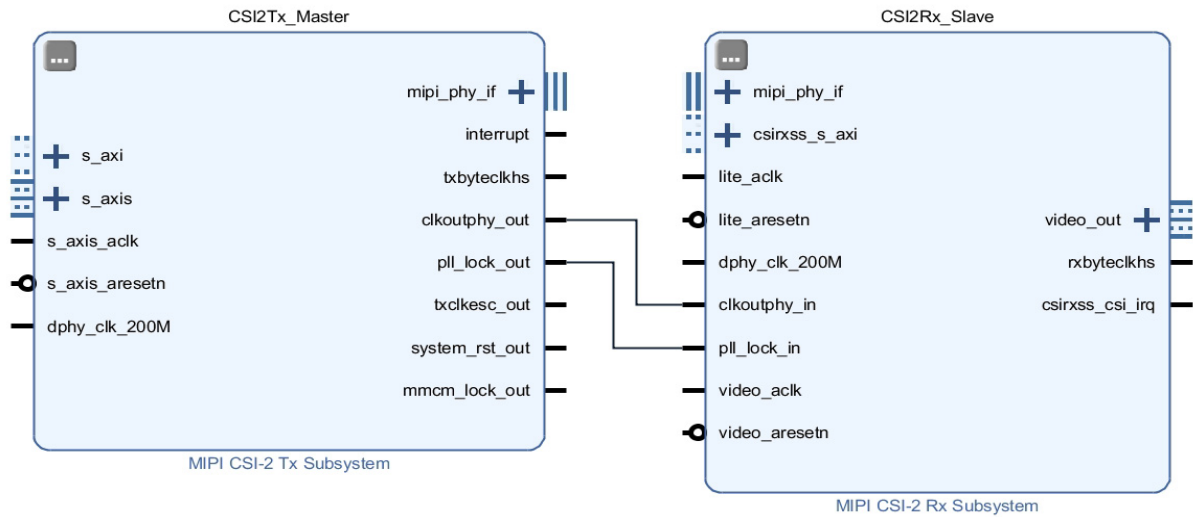

Figure 3-4: Clock Sharing in MIPI CSI-2 TX and MIPI CSI-2 RX Subsystems



IMPORTANT: MIPI CSI-2 TX Subsystem and MIPI CSI-2 RX Subsystem share clocking resources, in such scenario MIPI CSI-2 TX Subsystem need to be configured using **Include Shared Logic in Core** option under Shared Logic tab.



IMPORTANT: The master and slave can be configured with the different line rate when sharing *clkoutphy* within IO bank.

I/O Planning

The MIPI CSI-2 RX Subsystem provides an I/O planner feature for I/O selection. In the Pin Assignment tab, dedicated byte clocks (DBC) or quad byte clocks (QBC) are listed for the clock lane for the selected HP I/O bank. For the QBC clock lane, all of the I/O pins are listed for data lane I/O selection but for the DBC clock lane only the byte group I/O pins are listed for data lane I/O selection.

Eight MIPI CSI-2 RX Subsystem IP cores can be implemented per IO bank based on BITSLICE and BITSLICE_CONTROL instances in the UltraScale+ devices.



IMPORTANT: *If the RX data lane I/O pins are selected non-contiguously then an additional one, two, or three I/O pins (RX_BITSLICE) are automatically used for clock/Strobe propagation. Therefore, it is recommended that you select adjacent I/O pins for the RX configuration to make efficient use of the I/O. The propagation of strobes to the RX data pins follows the inter-byte and inter-nibble clocking rules given in the UltraScale Architecture SelectIO Resources User Guide (UG571) [Ref 15]. All lanes of a particular MIPI CSI-2 RX Subsystem instance need to be in the same HP IO bank which is automatically controlled by the Pin Assignment tab of the XGUI for Ultrascale+ devices. Multiple MIPI CSI-2 RX Subsystem instances sharing clocking resources also need to be in the same HP IO bank.*

Figure 3-5 shows the eight MIPI CSI-2 RX Subsystem IP cores configured with one clock lane and two data lanes and implemented in a single HP I/O bank.

The `csi2_rx_master` is configured with **Include Shared Logic in core** option and the remaining cores are configured with **Include Shared Logic in example design**. The constant `clkoutphy` signal is generated within the PLL of the `csi2_rx_master` core irrespective of line rate and is shared with all other slave IP cores (`csi2_rx_slave1` to `csi2_rx_slave7`) with different line rates.

Note: The master and slave cores can be configured with the different line rate when sharing `clkoutphy` within IO bank.

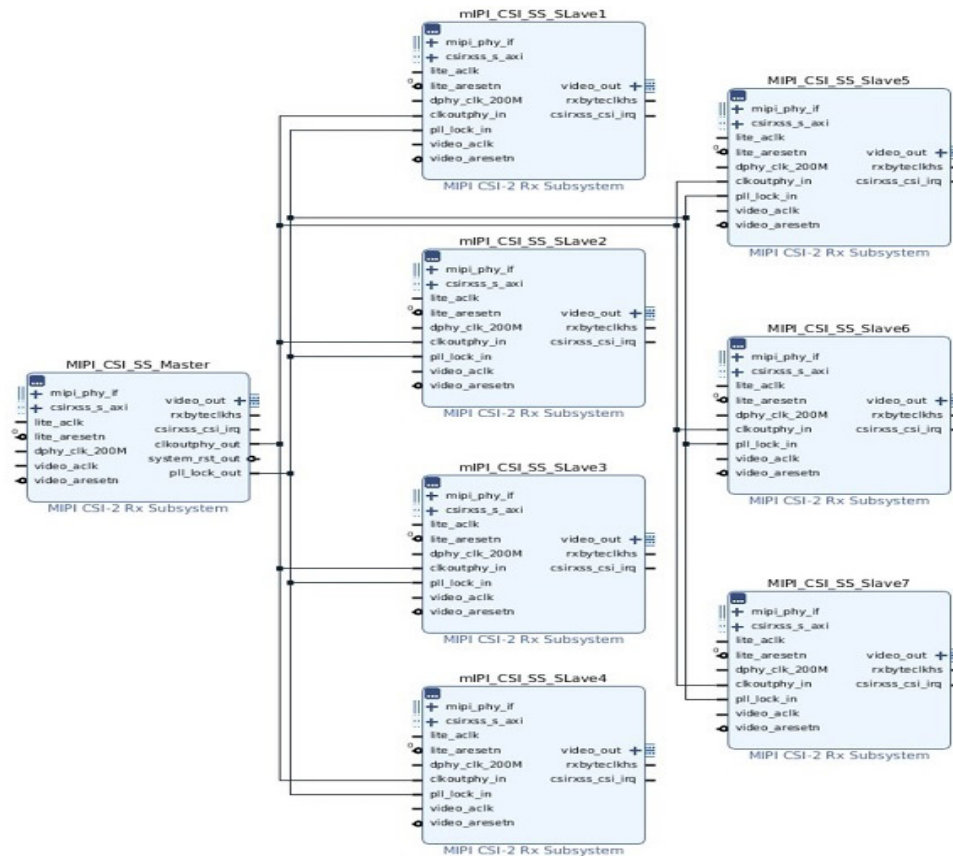

Figure 3-5: MIPI CSI-2 RX Subsystem Core Shared Logic Use Case for Single I/O Bank

Maximum number of MIPI CSI-2 interfaces which can be connected to single HP IO bank depends on the number of clock capable pins available on that bank.

Configuration		Shared Logic	Pin Assignment
HP IO Bank Selection			67
Name	Pin Loc	Pin Name	
Clock Lane	W12	IO_L1P_T0L_N0_DBC_67	
Data Lane0	W12	IO_L2P_T0L_N2_67	
Data Lane1	T12	IO_L3P_T0L_N4_AD15P_67	
Data Lane2	L16	IO_L4P_T0U_N6_DBC_AD7P_67	
Data Lane3	N13	IO_L5P_T0U_N8_AD14P_67	
	V8		
	T7		
	N9		
	P11		

Figure 3-6: Subsystem Customization Screen - Pin Assignment

Clocking

The subsystem clocks are described in [Table 3-1](#). Clock frequencies should be selected to match the throughput requirement of the downstream video pipe IP cores.

Table 3-1: Subsystem Clocks

Clock Name	Description
lite_aclk ⁽¹⁾	AXI4-Lite clock used by the register interface of all IP cores in the subsystem.
video_aclk ⁽²⁾	Clock used as core clock for all IP cores in the subsystem.
dphy_clk_200M	See the <i>MIPI D-PHY LogiCORE IP Product Guide</i> (PG202) [Ref 3] for information on this clock.
clkoutphy_out	The <code>clkoutphy_out</code> signal is generated within the PLL with 2500 Mb/s line rate when the Include Shared logic in core option is selected.
clkoutphy_in	The <code>clkoutphy_in</code> signal should be connected to the <code>clkoutphy_out</code> signal generated when the Include Shared logic in core option is selected.
rxbyteclkhs_cnts_out	The <code>rxbyteclkhs_cnts_out</code> is continuous clock signal generated within the PLL with frequency as <code>rxbyteclkhs</code> when Include Shared logic in core option is selected and linerates > 1500 Mb/s.
rxbyteclkhs_cnts_in	The <code>rxbyteclkhs_cnts_in</code> signal should be connected to <code>rxbyteclkhs_cnts_out</code> signal generated when the Include Shared logic in core option is selected and line rates >1500 Mb/s.

Notes:

1. The `lite_aclk` clock should be less than or equal to `video_aclk`.
2. Maximum recommended video clock is 250 MHz for UltraScale+ devices and 175 MHz for 7 Series devices. If required, a higher throughput can be achieved by increasing the Pixels per clock option from Single to Dual or Quad.

The MIPI CSI-2 RX Subsystem clocking structure is illustrated in [Figure 3-7](#) and [Table 3-2](#).

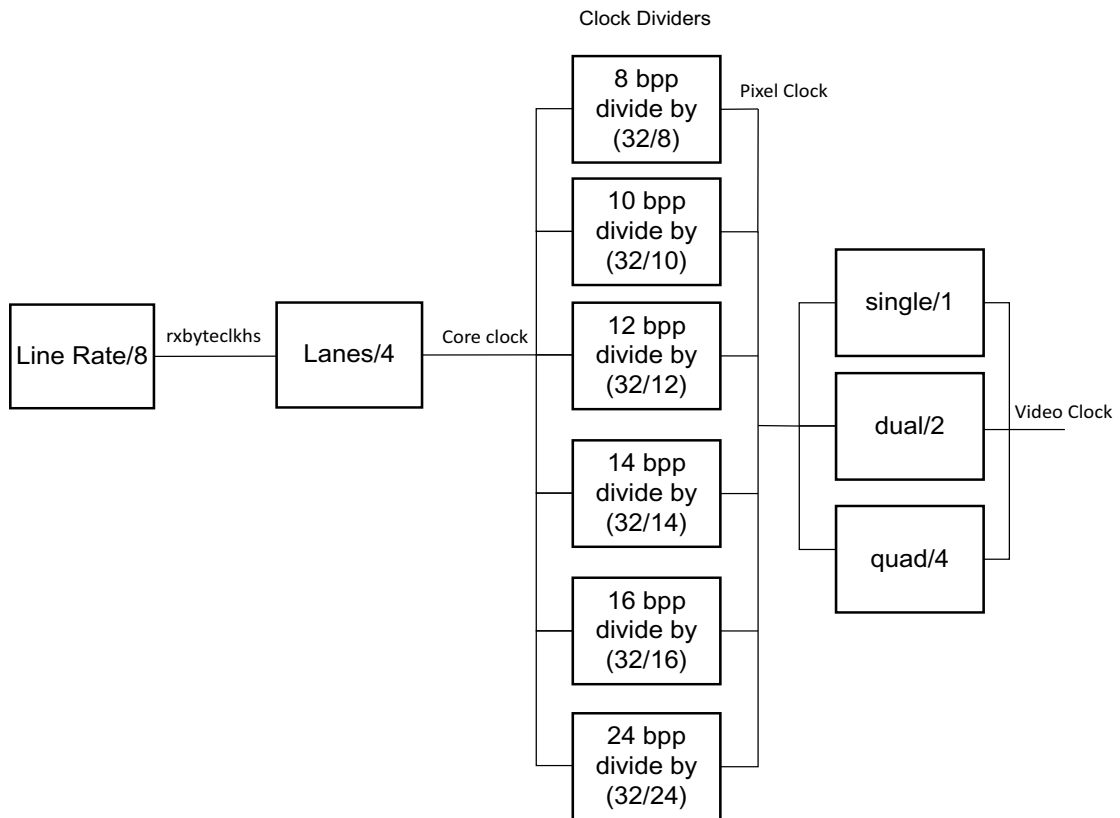

X16322-030916

Figure 3-7: Clocking Structure

Table 3-2: Clocking

Clock	Function	Frequency	Example
Rxbyteclkhs	Byte clock for all lane PPI operation.	1/8 of line rate	Line rate = 1000 Mb/s Rxbyteclkhs = 1000/8 = 125 MHz
Core clock	Core clock for the modules.	Lanes/4 of rxbyteclkhs	Example 1 Line rate = 1000 Mb/s, Lanes = 4 Core clock = 125*4/4 = 125 MHz Example 2 Lane rate = 1000 Mb/s, Lanes = 3 Core clock = 125*3/4 = 93.75 MHz
Pixel clock ⁽¹⁾⁽²⁾	Internal pixel clock	For 8 bpp clock = core clock/(32/8) For 24 bpp clock = core clock/(32/24)	

Table 3-2: Clocking (Cont'd)

Clock	Function	Frequency	Example
Video ⁽¹⁾ clock	Clock used for video interface	for single pixel video clock=pixel clock for dual pixel video clock=pixel clock/2 for quad pixel video clock=pixel clock/4	Example 1 125 MHz for single pixel wide 125 MHz/2 = 62.5 MHz for dual pixel 125 MHz/4 = 31.25 MHz for quad pixel Example 2 93.75 MHz for single pixel wide 93.75 MHz/2 = 46.875 MHz for dual pixel 93.75 MHz/4 = 23.43 MHz for quad pixel

Notes:

1. This clock is not used in the system. It is only listed to illustrate the clock relations.
2. bbp is bits per pixel.

The read path of the lane management block in the CSI-2 RX Controller operates on a 32-bit data path (irrespective of the number of lanes) and uses the video clock for processing the data. Therefore, the minimum required video clock for line rates ≤ 1500 Mb/s should be greater than or equal to the effective PPI clock divided by 4.

The following examples illustrate this:

- For a MIPI interface with 1000 Mb/s per lane, 1 lane design, the effective rate at which the lane management block is written is 125 MHz. Because the lane management block read path operates on a 32-bit (4-byte) data path, the minimum required video clock is 125 MHz / 4 or higher.
- For a MIPI interface with 800 Mb/s, 2 lane design, the effective rate at which the lane management block is written is 100 MHz * 2. Because the lane management block read path operates on a 32-bit (4-byte) data path, the minimum required video clock is (100 MHz * 2) / 4 or higher.
- For a MIPI interface with 700 Mb/s per lane, 3 lane design, the effective rate at which the lane management block is written is 87.5 MHz * 3. Because the lane management block read path operates on a 32-bit (4-byte) data path, the minimum required video clock is (87.5 MHz * 3) / 4 or higher.
- For a MIPI interface with 1200 Mb/s per lane, 4 lane design, the effective rate at which the lane management block is written is 150 MHz * 4. Because the lane management block read path operates on 32-bit (4-byte) data path, the minimum required video clock is (150 MHz * 4) / 4 or higher.

Apart from the minimum video clock requirement mentioned above, it is equally important to ensure that at any given time, the output bandwidth of the subsystem is greater than or equal to the input bandwidth.

The following example illustrates this:

- For a MIPI interface with 1000 Mb/s per lane, 1 lane, quad pixel mode design processing RAW10 data, the minimum required video clock is $(1000 * 1) / 4 / 10$ or higher. Where 10 represents the number of bits in one RAW10 pixel.

Below is the equation used to calculate the minimum required video clock

$$\text{video_aclk1(MHz)} = \text{Line Rate(Mb/s)} * \text{Data Lanes} / 8 / 4$$

$$\text{video_aclk2(MHz)} = (\text{Line Rate(Mb/s)} * \text{Data Lanes}) / \text{Pixel Mode} / \text{Number of Bits Per Pixel}$$

The effective minimum required video clock is:

$$\text{video_aclk(MHz)} = \text{Max} \{ \text{video_aclk1} , \text{video_aclk2} \}$$

For line rates > 1500 Mb/s, there is no limitation with respect to read path of the lane management block in MIPI CSI-2 Rx Controller. So , the effective minimum required clock for line rates >1500 Mb/s is:

$$\text{video_aclk(MHz)} = \text{video_aclk2}$$

Resets

The subsystem has two reset ports:

- `lite_aresetn`: Active-Low reset for the AXI4-Lite register interface.
- `video_aresetn`: Active-Low reset for the subsystem blocks.

The duration of `video_aresetn` should be a minimum of 40 `dphy_clk_200M` cycles to propagate the reset throughout the system. See [Figure 3-8](#).

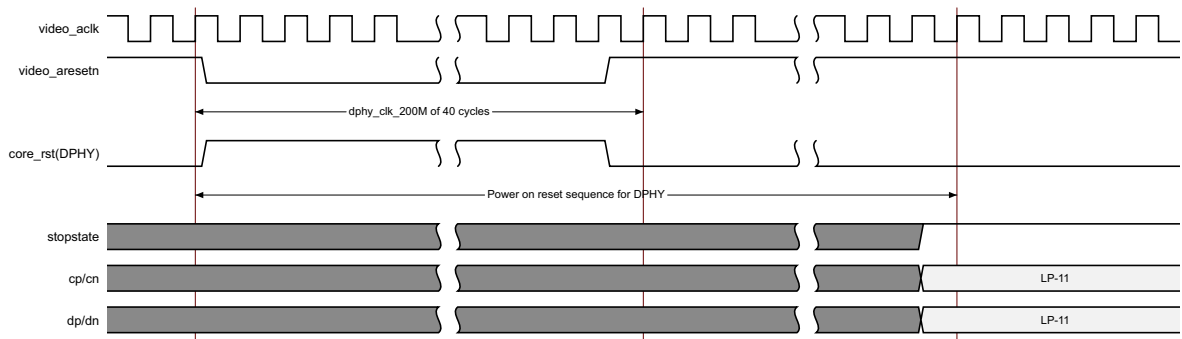

Figure 3-8: MIPI CSI-2 RX Reset

[Table 3-3](#) summarizes all resets available to the MIPI CSI-2 RX Subsystem and the components affected by them.

Table 3-3: Resets

Sub-core	Lite_aresetn	Video_aresetn
MIPI CSI-2 RX Controller	Connected to s_axi_aresetn core port	Connected to m_axis_aresetn core port
MIPI D-PHY	Connected to s_axi_aresetn core port	Inverted signal connected to core_rst core port
Video Format Bridge	N/A	Connected to s_axis_aresetn core port
AXI Crossbar	Connected to aresetn core port	N/A

Note: The effect of each reset (`lite_resetn`, `video_aresetn`) is determined by the ports of the sub-cores to which they are connected. See the individual sub-core product guides for the effect of each reset signal.

Protocol Description

Programming Sequence

This section contains the programming sequence for the subsystem. Program and enable the components of subsystem in the following order:

1. MIPI CSI-2 RX Controller
2. MIPI D-PHY (if register interface is enabled)

Address Map Example

Table 3-4 shows an example based on a subsystem base address of 0x44A0_0000 (32-bits) when the MIPI D-PHY register interface is enabled.

Table 3-4: Address Map Example

Core	Base Address
MIPI CSI-2 RX Controller	0x44A0_0000
MIPI D-PHY	0x44A1_0000

MIPI CSI-2 RX Controller Core Programming

The MIPI CSI-2 RX Controller programming sequence is as follows and Figure 3-9 shows a graphical representation of the sequence:

1. After power on reset (`video_aresetn`), the core enable bit is, by default, set to 1 so the core starts processing packets sent on the PPI. The Active Lanes parameter is set to Maximum Lanes (configured in the Vivado IDE using the **Serial Data Lanes** parameter).

2. Disabling and re-enabling the core

- Disable the core using the [Core Configuration Register](#) (set the Core Enable bit to 0 or the Soft reset bit to 1).
- Wait until the core clears the Soft reset/Core enable in progress bit by reading the [Core Status Register](#).
- Change the required core settings (for example, active lanes configuration, enabling interrupts)
- Re-enable the core (set the Core Enable bit to 1 or the Soft Reset bit to 0)

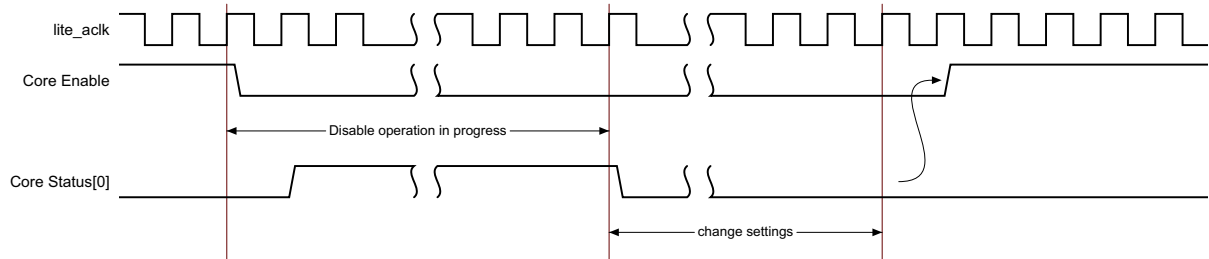

Figure 3-9: Core Programming Sequence

IMPORTANT: Ensure that the core enable is asserted only when MIPI TX is transmitting either LP-11 or LP-00 state. Failing to do so will result in unsuccessful IP initialization.

Active Lanes Configuration

The Protocol Configuration Register [1:0] can be used to dynamically configure the active lanes used by the subsystem using the following guidelines:

1. Program the required lanes in the Protocol Configuration register (only allowed when **Enable Active Lanes** is set in the Vivado IDE).
2. The subsystem internally updates the new lanes information after the current packet complete indication is seen (for example, when the current active lanes indicate a Stop state condition) and a subsequent RxByteClkHS signal is seen on the PPI.
3. A read from the Protocol Configuration register reflects the new value after the subsystem has successfully updated the new lanes information internally.
4. Do not send the new updated lanes traffic until the read from Protocol Configuration registers reflects the new value.

Note: The Active Lane bit field will not be updated if the RxByteClkHS is absent. This will be indicated by the MIPI DPHY RX Clock lane being in stop state. After updating the active lanes field, if the MIPI DPHY RX Clock lane is in stop state, you can continue without waiting for the Active Lane bit field getting updated. Once the DPHY RX Clock Lane is out of stop state, you can check for this field to get updated with programmed value

MIPI D-PHY IP Core Programming

See the *MIPI D-PHY LogiCORE IP Product Guide* (PG202) [\[Ref 3\]](#) for MIPI D-PHY IP core programming details.

Design Flow Steps

This chapter describes customizing and generating the subsystem, constraining the subsystem, and the simulation, synthesis and implementation steps that are specific to this subsystem. More detailed information about the standard Vivado[®] design flows and the IP integrator can be found in the following Vivado Design Suite user guides:

- *Vivado Design Suite User Guide: Designing IP Subsystems using IP Integrator* (UG994) [\[Ref 7\]](#)
- *Vivado Design Suite User Guide: Designing with IP* (UG896) [\[Ref 8\]](#)
- *Vivado Design Suite User Guide: Getting Started* (UG910) [\[Ref 9\]](#)
- *Vivado Design Suite User Guide: Logic Simulation* (UG900) [\[Ref 10\]](#)

Customizing and Generating the Subsystem

This section includes information about using Xilinx tools to customize and generate the subsystem in the Vivado Design Suite.

If you are customizing and generating the subsystem in the Vivado IP integrator, see the *Vivado Design Suite User Guide: Designing IP Subsystems using IP Integrator* (UG994) [\[Ref 7\]](#) for detailed information. IP integrator might auto-compute certain configuration values when validating or generating the design. To check whether the values do change, see the description of the parameter in this chapter. To view the parameter value, run the `validate_bd_design` command in the Tcl console.

You can customize the IP for use in your design by specifying values for the various parameters associated with the subsystem using the following steps:

1. Select the IP from the Vivado IP catalog.
2. Double-click the selected IP or select the **Customize IP** command from the toolbar or right-click menu.

For details, see the *Vivado Design Suite User Guide: Designing with IP* (UG896) [\[Ref 8\]](#) and the *Vivado Design Suite User Guide: Getting Started* (UG910) [\[Ref 9\]](#).

Note: Figures in this chapter are illustrations of the Vivado Integrated Design Environment (IDE). The layout depicted here might vary from the current version.

The subsystem configuration screen for UltraScale+ device is shown in [Figure 4-1](#).

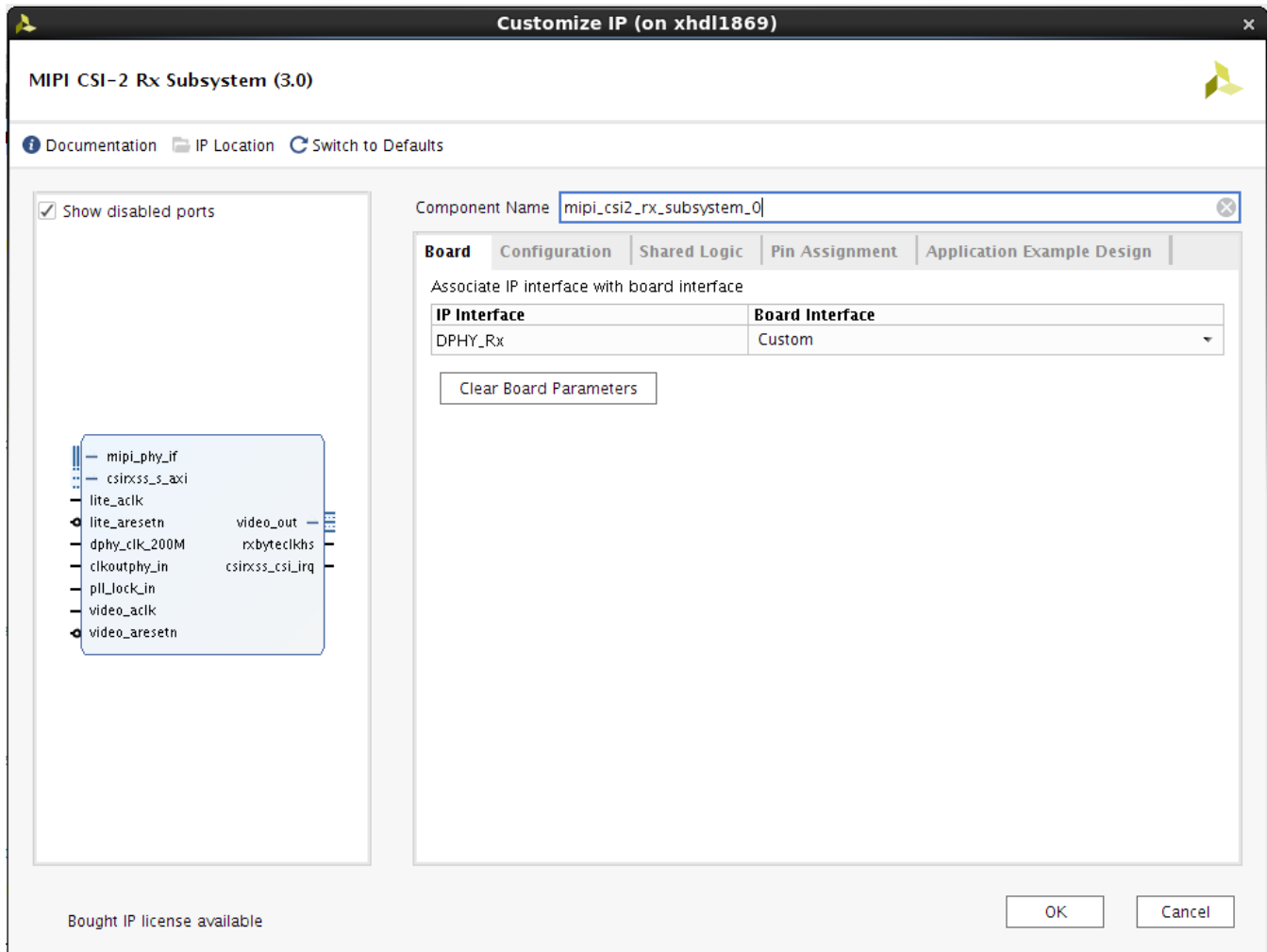

Figure 4-1: Subsystem Customization Screen - Board

Component Name: The Component Name is used as the name of the top-level wrapper file for the subsystem. The underlying netlist still retains its original name. Names must begin with a letter and must be composed from the following characters: a through z, 0 through 9, and "_". The default is mipi_csi2_rx_subsystem_0.

Board Tab

The Board tab page provides board automation related parameters. The subsystem board configuration screen is shown in [Figure 4-1](#).

Board Interface: Select the board parameters.

- **Custom:** Allows user to configure custom values (no board automation support).

- **fmc_hpc0_connector_EV_CSI2Rx_I2**: Applicable only for ZCU102 board with FMC_HPC0 connector selected as LI-IMX274MIPI-FMC V1.0 during board selection for 2-lane MIPI CSI-2 Rx Subsystem.
- **fmc_hpc0_connector_EV_CSI2Rx_I2**: Applicable only for ZCU102 board with FMC_HPC0 connector selected as LI-IMX274MIPI-FMC V1.0 during board selection for 4-lane MIPI CSI-2 Rx Subsystem.
This selection automatically configures the MIPI CSI-2 Rx Subsystem to support IMX274 camera sensor which can be connected to EV FMC card. For more information, see the [LI-IMX274MIPI-FMC](#) product page.

Configuration Tab

The Configuration tab page provides core related configuration parameters. The subsystem configuration screen is shown in [Figure 4-2](#).

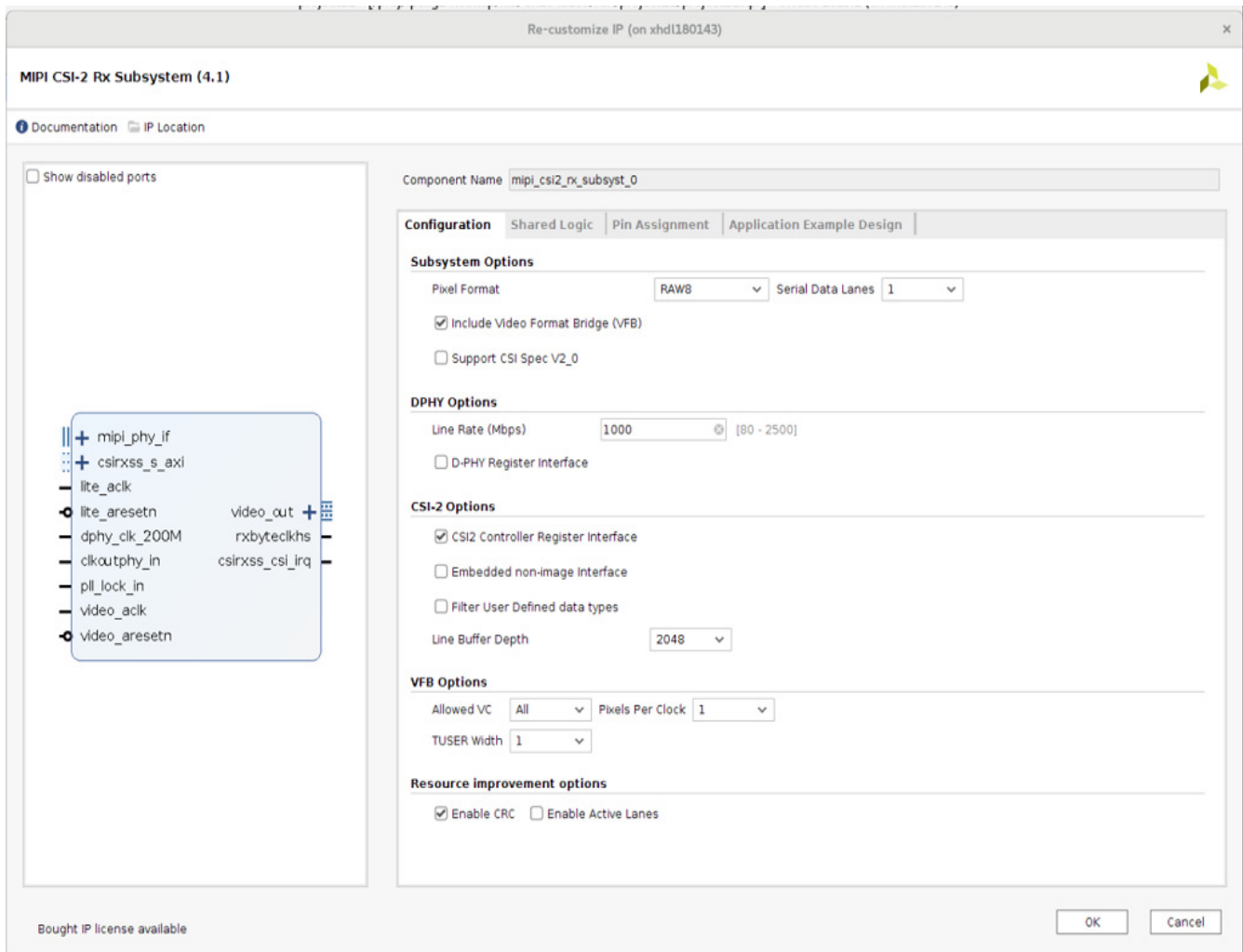

Figure 4-2: Subsystem Customization Screen - Configuration

Pixel Format: Select Data Type (pixel format) as per the CSI-2 protocol (RAW6, RAW7, RAW8, RAW10, RAW12, RAW14, RGB888, RGB666, RGB565, RGB555, RGB444, YUV422_8bit).

Serial Data Lanes: Select the maximum number of D-PHY lanes for this subsystem instance. Values are 1, 2, 3, or 4.

Include Video Format Bridge (VFB): Option to include or exclude the Video Format Bridge core in the subsystem.

Support CSI Spec V2_0: Select to enable CSI V2.0 features (RAW16, RAW20 support and VCX feature support).

Support VCX Feature: Option to include or exclude VCX feature.

Line Rate (Mb/s): Select the line rate for the MIPI D-PHY core. Value in the range, 80 to 2500 Mb/s based on the device selected. Vivado IDE automatically limits the line rates based on the device selected. For details about family/device specific line rate support refer *UltraScale Architecture SelectIO Resources User Guide* (UG571) [Ref 15]. See the respective 7 Series family device data sheet for details on the upper line rate limits.

D-PHY Register Interface: Select to enable the register interface for the MIPI D-PHY core.

Enable Deskew Detection: Select to enable Deskew sequence detection and centre alignment of clock and data lanes in MIPI D-PHY.

Note: Applicable only for Ultrascale+ devices with line rates above 1500 Mb/s

Calibration Mode: Select the calibration for 7 Series MIPI D-PHY RX Subsystem. Values are None, Fixed, or Auto. When set to None, the **Calibration Mode** does not add IDELAY2 primitive. Fixed as **Calibration Mode** will set IDELAYE2 TAP value set in **IDELAY Tap Value**. Auto as **Calibration Mode** will add IDELAYE2 primitive and tap value will be configured by D-PHY RX IP based on received traffic and calibration algorithm.

IDELAY Tap Value: Select the IDELAY TAP value used for calibration in Fixed mode. Value in the range, 1 to 31.

Include IDELAYCTRL in core: Select to include IDELAYCTRL in core. Only available in FIXED and AUTO calibration modes. For multiple MIPI CSI-2 Rx IP cores that are sharing single IO bank, select **Include IDELAYCTRL** option in the IP for the auto calibration mode. Only one **IDELAYCTRL** is available per a single clock region. If multiple MIPI CSI-2 RX cores exist in single clock region, select this option for only one MIPI CSI-2 RX IP core. For the rest of MIPI CSI-2 RX cores, this option should be unselected.

Note: This option is applicable only for 7 Series MIPI CSI-2 RX IP configurations.

Note: For 7 Series in AUTO Mode, when there are multiple instances of DPHY and they share the IDELAY control Ready from one DPHY Instance to other DPHY Instance. The DPHY Instance which shares the IDELAY Controller Ready cannot have Parameter "Enable 300 MHz clock for IDELAYCTRL" set to true.

Note: For 7 Series, IP is tested and validated for Max 1250 Mb/s , 1500 Mb/s opened up in the GUI just for the users for their testing.

IDELAY_GROUP Name: This parameter is used to select the IDELAY_GROUP Name for the IDELAYCTRL. All core instances in the same bank sharing IDELAYCTRL should have the same name for this parameter. Select a unique name per bank.

Note: Available only for 7 series configurations.

Enable 300 MHz clock for IDELAYCTRL: Select to enable external 300 MHz clock port. Only available in AUTO calibration mode. This 300 MHz port is used for connecting to IDELAYCTRL. When you disable this option, IDELAYCTRL uses 200 MHz clock (dphy_clk_200M).

CSI2 Controller Register Interface: Unselect to remove MIPI CSI-2 RX Controller register interface. Disabling this option will improve resource count. When CSI-2 Rx Controller register interface is disabled, core allows to enable/disable the core through external ports. And some of the key status information are made available as external ports of the core. See [Port Descriptions](#) section for details of ports available when this option is unselected.

Embedded non-image Interface: Select to process and offload embedded non-image CSI-2 packets (with data type code 0x12) using a separate AXI4-Stream interface. If unselected, such packets are not processed and are ignored by the CSI-2 RX controller.

Filter User Defined data types: Select to Filter user defined data types (0x30 to 0x37) and do not output on Image interface (unsupported ErrId ISR[8] will not be set even filtering is enabled). If unselected, such packets are processed and presented on image interface.

Line Buffer Depth: Depth of internal RAM used to accommodate throttling on the output video interface. Values are 128, 256, 512, 1024, 2048, 4096, 8192, or 16384.

Note: There is no throttling allowed on the input to the PPI.

Pixels Per Clock: Select the number of pixels to output per clock on output interface. Values are 1 (single pixel), 2 (dual pixel), or 4 (quad pixel).

TUSER Width: Width of the sideband signal [TUSER] to report information like the line number, frame number, ECC, and CRC.

Allowed VC: Select the VC values to be used to while processing the packets. Values are All, 0, 1, 2, or 3.

Enable CRC: When set, CRC computation is performed on the packet payload and any errors are reported.

Enable Active Lanes: When set, the core supports the dynamic configuration of the number of active lanes from the maximum number of lanes selected during core generation using the parameter **Serial Data Lanes**. For example, when **Serial Data Lanes** is set to 3, the number of active lanes can be programmed using the protocol configuration register to be

1, 2, or 3. The core reports an error when the active lanes setting is greater than the serial lanes setting through the interrupt status register, bit 21.

Shared Logic Tab

The Shared Logic tab page provides shared logic inclusion parameters. The subsystem shared logic configuration screen is shown in Figure 4-3.

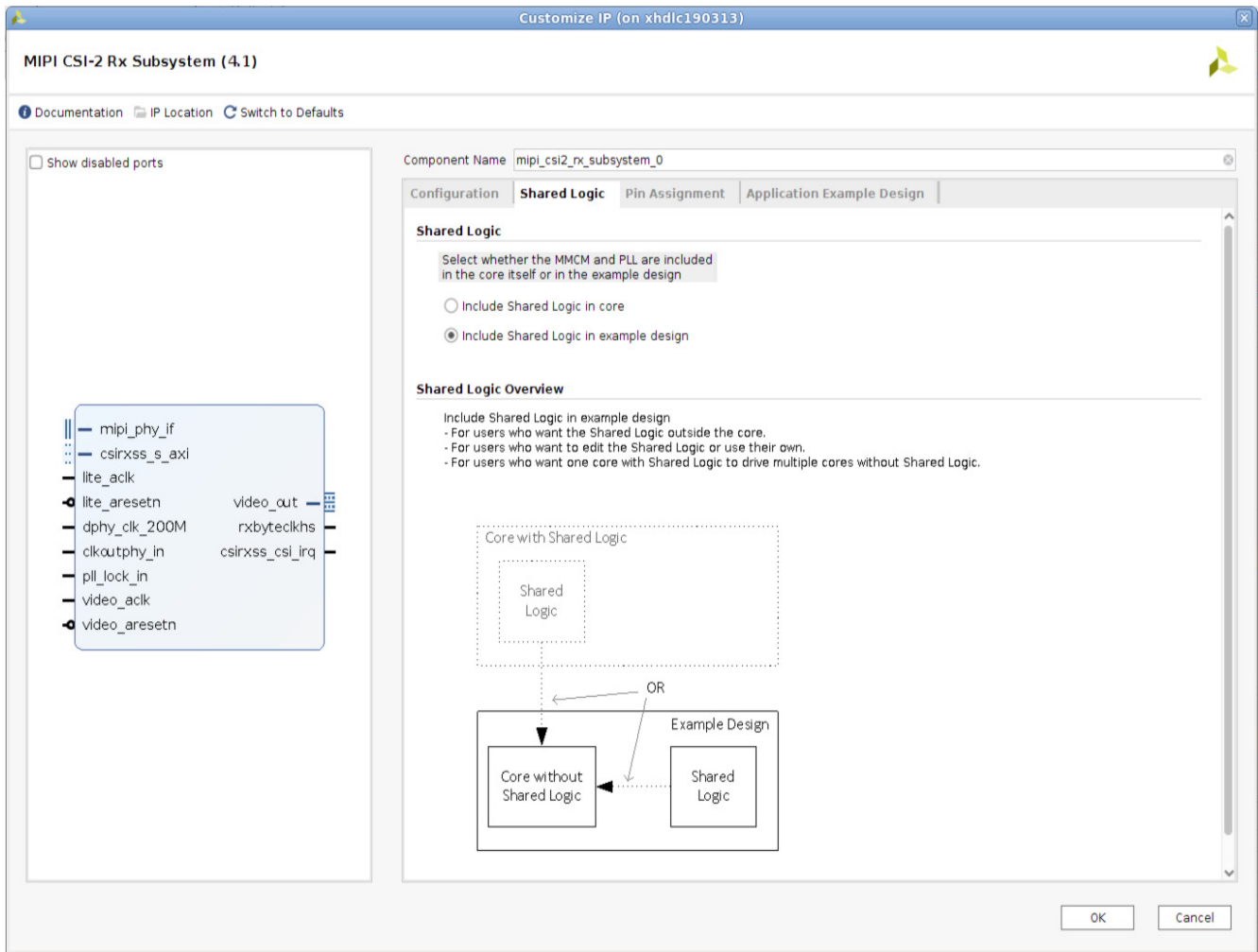

Figure 4-3: Subsystem Customization Screen - Shared Logic

Shared Logic: Select whether the PLL are included in the core or in the example design. Values are:

- Include Shared Logic in core
- Include Shared Logic in example design

Pin Assignment Tab

The Pin Assignment tab page allows to select pins. The subsystem pin assignment configuration screen is shown in [Figure 4-4](#).

Note: This tab is not available for Xilinx 7 Series device configurations.

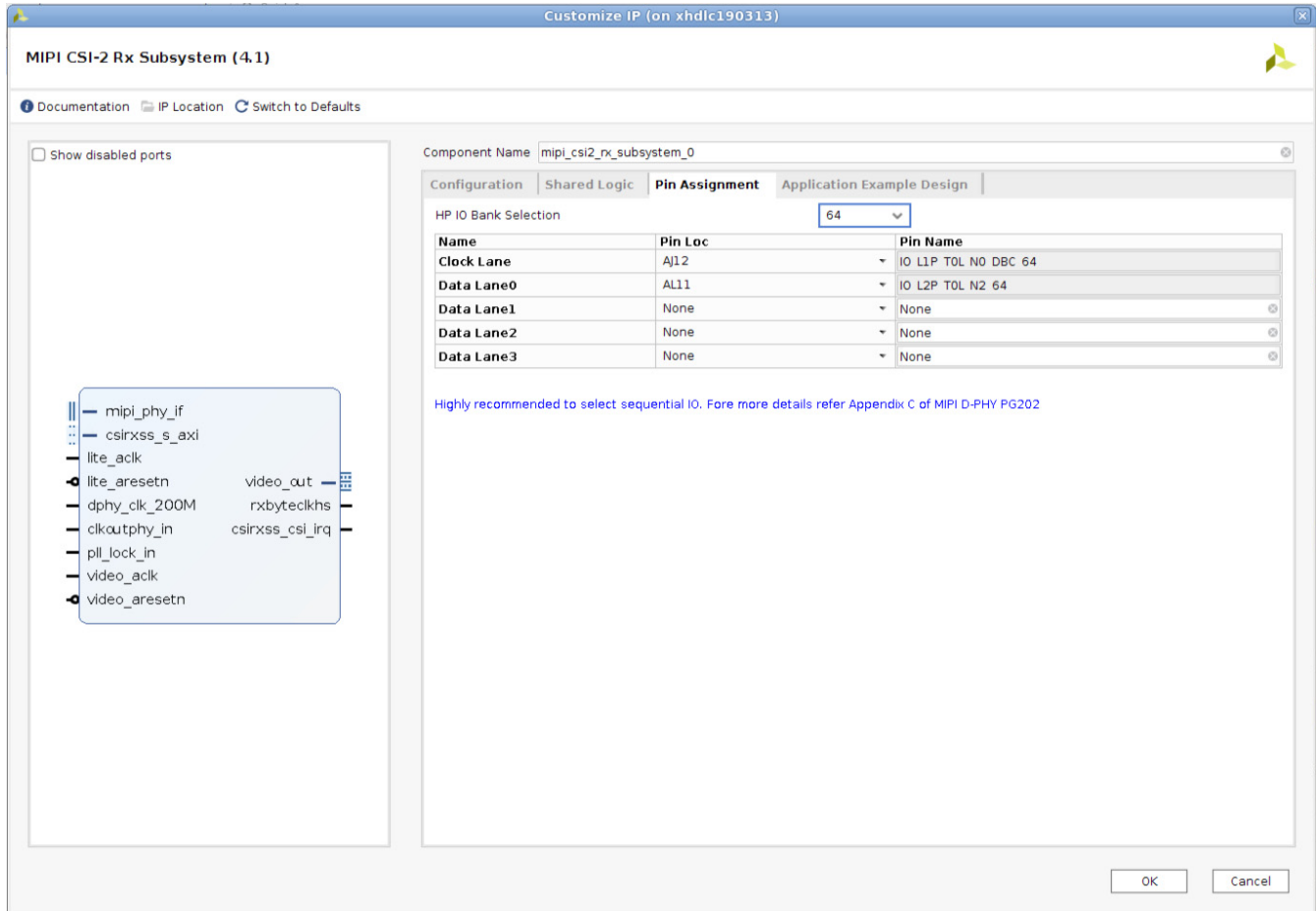

Figure 4-4: Subsystem Customization Screen - Pin Assignment

HP IO Bank Selection: Select the HP I/O bank for clock lane and data lane implementation.

Clock Lane: Select the LOC for clock lane. This selection determines the I/O byte group within the selected HP I/O bank.

Data Lane 0/1/2/3: Displays the Data lanes 0, 1, 2, and 3 LOC based on the clock lane selection.

Application Example Design

The Application Example Design tab page provides example design parameters. The subsystem application example design configuration screen is shown in [Figure 4-5](#).

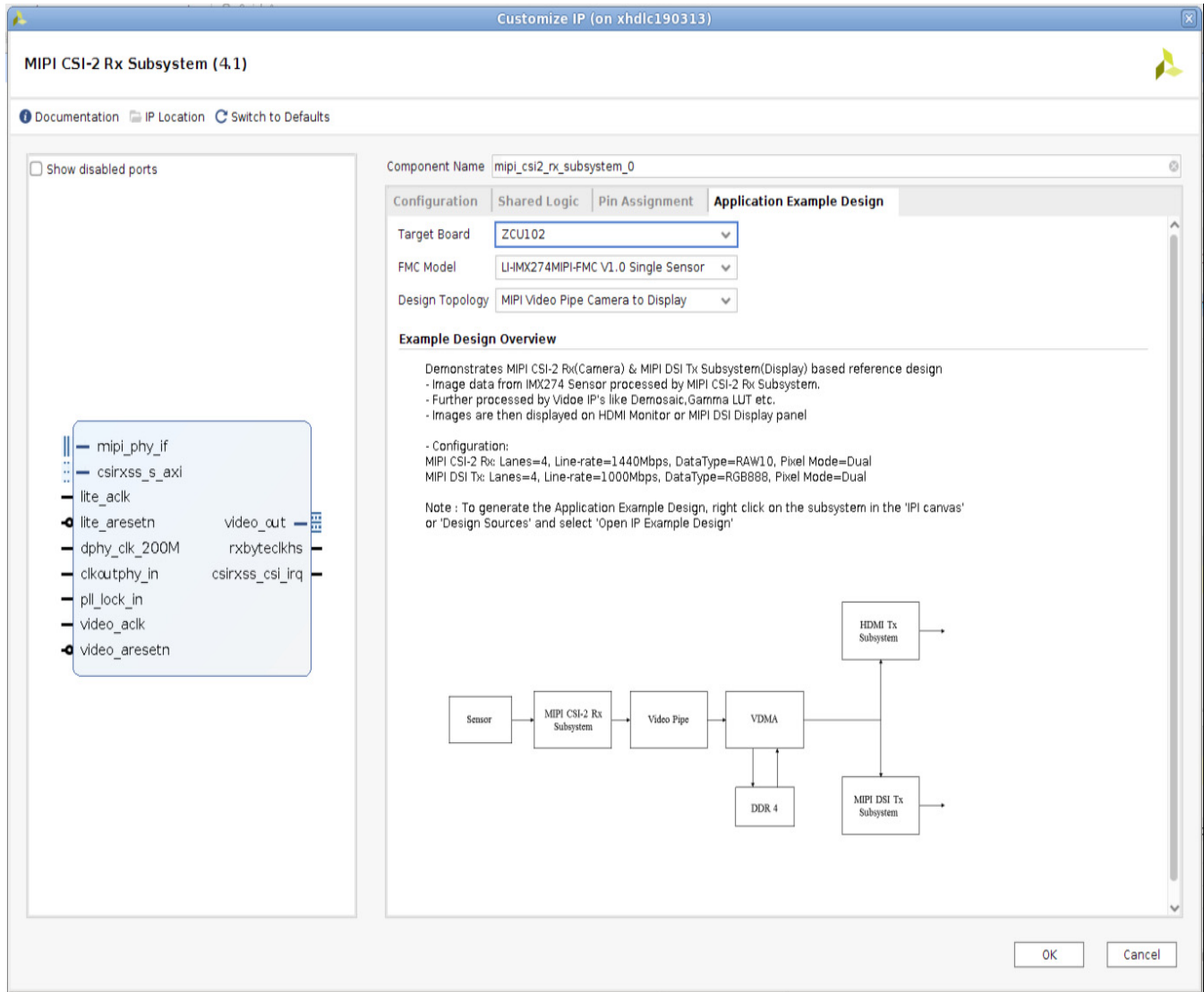

Figure 4-5: Subsystem Customization Screen - Application Example Design

Target Board: Target board on which the Application example design to be built. Supported value(s) are ZCU102 and SP701.

FMC Model: FMC Model to connect MIPI Camera Sensor and MIPI Display. Supported value(s) are LI-IMX274MIPI-FMC V1.0 Single Sensor.

Design Topology: Application example design configuration type. Select **MIPI_Video_Pipe_Camera_to_Display** to view the flow from camera receive path to display path either on HDMI monitor or MIPI DSI display.

User Parameters

Table 4-1 shows the relationship between the fields in the Vivado IDE and the User Parameters (which can be viewed in the Tcl Console).

Table 4-1: Vivado IDE Parameter to User Parameter Relationship

Vivado IDE Parameter	User Parameter	Default Value
Pixel Format	CMN_PXL_FORMAT	RAW8
Serial Data Lanes	CMN_NUM_LANES	1
Allowed VC	CMN_VC	All
Pixels Per Clock	CMN_NUM_PIXELS	1
Include video Format Bridge (VFB)	CMN_INC_VFB	True
Support CSI Spec V2_0	C_EN_CSI_V2_0	False
Support VCX Feature	C_EN_VCX	False
Line Rate (Mb/s)	DPY_LINE_RATE	1000
D-PHY Register Interface	DPY_EN_REG_IF	False
Calibration Mode	C_CAL_MODE	None
IDELAY Tap Value	C_IDLY_TAP	1
Include IDELAYCTRL in Core	C_SHARE_IDLYCTRL	False
Enable 300 MHZ Clock for IDELAYCTRL	C_EN_CLK300M	False
Embedded non-image Interface	CSI_EMB_NON_IMG	False
Line Buffer Depth	CSI_BUF_DEPTH	2048
Enable CRC	C_CSI_EN_CRC	True
Enable Active Lanes	C_CSI_EN_ACTIVELANES	False
Shared Logic	Support Level	0
HP IO Bank Selection	HP_IO_BANK_SELECTION	Value based on part selected.
Clock Lane	CLK_LANE_IO_LOC	Value based on part selected
Data Lane0	DATA_LANE0_IO_LOC	Value based on part selected
Data Lane1	DATA_LANE1_IO_LOC	Value based on part selected
Data Lane2	DATA_LANE2_IO_LOC	Value based on part selected
Data Lane3	DATA_LANE3_IO_LOC	Value based on part selected
HS_SETTLE Parameter (ns)	C_HS_SETTLE_NS	145 Note: Hidden parameter which can be used to set HS_SETTLE value. Can be set through Tcl flow.
Filter User Defined data types	C_CSI_FILTER_USERDATA TYPE	False
Target Board	C_EXDES_BOARD	ZCU102

Table 4-1: Vivado IDE Parameter to User Parameter Relationship (Cont'd)

Vivado IDE Parameter	User Parameter	Default Value
FMC Model	C_EXDES_FMC	LI-IMX274MIPI-FMC V1.0 Single Sensor
Design Topology	C_EXDES_CONFIG	MIPI_Video_Pipe_Camera_to_Display
TDATA Width	AXIS_TDATA_WIDTH	32
TDEST Width	AXIS_TDEST_WIDTH	4
TUSER Width (CSI-2 options)	AXIS_TUSER_WIDTH	96
TUSER Width (VFB options)	VFB_TU_WIDTH	1

Output Generation

For details, see the *Vivado Design Suite User Guide: Designing with IP* (UG896) [Ref 8].

Constraining the Subsystem

This section contains information about constraining the subsystem in the Vivado Design Suite.

Required Constraints

The XDC constraints are delivered when the subsystem is generated.

Device, Package, and Speed Grade Selections

The maximum possible line rate per lane is dependent on device selected.

For details about family/device specific line rate support refer *UltraScale Architecture SelectIO Resources User Guide* (UG571) [Ref 15]. See the respective Xilinx 7 series FPGA family device data sheet for details on the upper line rate limits.

Clock Frequencies

See [Clocking](#).

Clock Management

The MIPI CSI-2 RX Subsystem generates the required clock constraints when generated using out-of-context mode with <component_name>_fixed_ooc.xdc. You can use these or update as required for other clock constraints.

Clock Placement

This section is not applicable for this subsystem.

Banking

The MIPI CSI-2 RX Subsystem MIPI D-PHY sub-core provides a Pin Assignment tab in the Vivado IDE to select the HP I/O bank. The clock lane and data lane(s) are implemented on the selected I/O bank BITSlice(s).

Note: This tab is not available for Xilinx 7 series FPGA device configurations.

Transceiver Placement

This section is not applicable for this subsystem.

I/O Standard and Placement

MIPI standard serial I/O ports should use MIPI_DPHY_DCI for the I/O standard in the XDC file for UltraScale+ family. The LOC and I/O standards must be specified in the XDC file for all input and output ports of the design. The MIPI CSI-2 RX Subsystem, MIPI D-PHY sub-core generates the I/O pin LOC for the pins that are selected during IP customization. No I/O pin LOC are provided for Xilinx 7 series FPGA designs.

You will have to manually select the clock capable I/O for Xilinx 7 series FPGA RX clock lane and restrict the I/O selection within the I/O bank.

It is recommended to select the IO bank with VPR pin connected for UltraScale+ MIPI CSI-2 RX Subsystem configurations. If VPR pin is present in other I/O bank in the same I/O column of the device the following DCI_CASCADE XDC constraint should be used. For example, I/O bank 65 has a VPR pin and the D-PHY TX IP is using the IO bank 66.

```
set_property DCI_CASCADE {66} [get_iobanks 65]
```

Simulation

Simulation supported example design is not available for MIPI CSI-2 RX Subsystem. However user can generate MIPI CSI-2 Tx Subsystem simulation example design to analyze the simulation behavior of MIPI CSI-2 Rx Subsystem. MIPI CSI-2 RX Subsystem provides an Application Example Design which can be implemented on the hardware. See [Chapter 5, Application Example Design](#) for details.

For comprehensive information about Vivado simulation components, as well as information about using supported third-party tools, see the *Vivado Design Suite User Guide: Logic Simulation* (UG900) [\[Ref 10\]](#).

Synthesis and Implementation

For details about synthesis and implementation, see the *Vivado Design Suite User Guide: Designing with IP* (UG896) [\[Ref 8\]](#).

Application Example Design

This chapter contains step-by-step instructions for generating an MIPI CSI-2 Rx Subsystem application example design from the MIPI CSI-2 Rx Subsystem by using the Vivado® flow.

Table 5-1: Hardware Details of the Application Example Design

Topology	Hardware	Processor	Lanes, Line-rate, and Data Type
MIPI Video Pipe Camera to Display	<ul style="list-style-type: none"> ZCU102 Rev 1.0 AUOS display panel (B101UAN01.7_H/W 1A) LI-IMX274MIPI-FMC camera sensor module HDMI monitor supporting 4K@30 fps with at least 12 bpc color depth 	Zynq® MPSoC	4 Lanes, 1440 Mb/s Lane, RAW10
MIPI Video Pipe Camera to Display	<ul style="list-style-type: none"> SP701 Rev 1.1 AUOS display panel(B10UAN01.7_H/W 1A)) PCAM-5C camera sensor module HDMI Monitor 	Microblaze	2 Lanes, 900 Mb/s Lane, RAW10

ZCU102 Application Example Design Overview

The Application Example Design demonstrates the usage of the MIPI CSI-2 RX Subsystem and MIPI DSI TX Subsystem on Zynq Ultra Scale+ ZCU102 board. On the capture path, the system receives images captured by IMX274 image sensor. Processed images are displayed on either the HDMI monitor or MIPI DSI Display.

A block diagram of the MIPI CSI-2 Rx Subsystem Application Example Design is shown in [Figure 5-1](#).

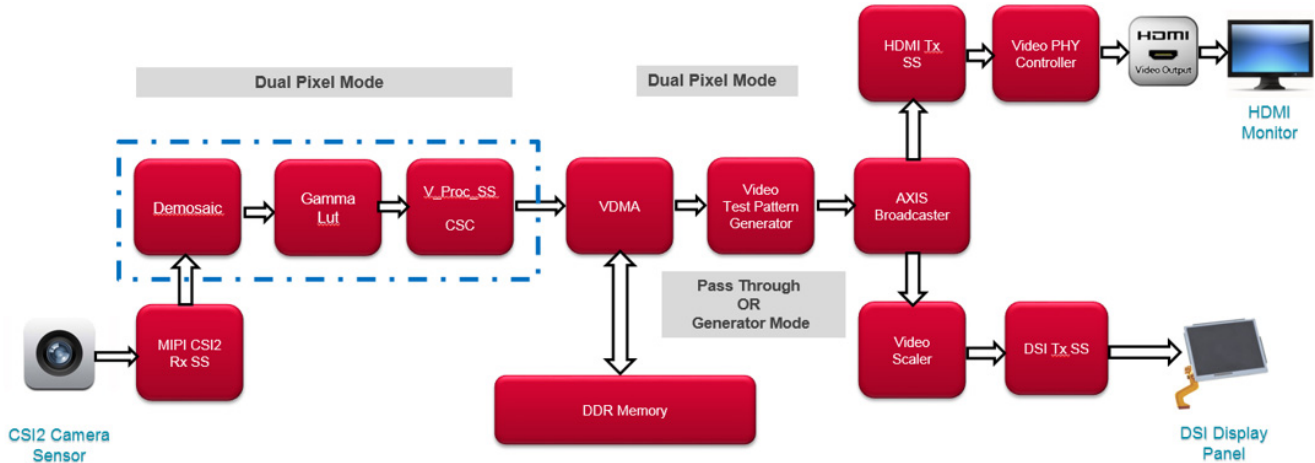

Figure 5-1: MIPI CSI-2 Rx Subsystem Application Example Design Block Diagram

The MIPI CSI-2 RX Subsystem decodes, processes video data and presents on AXI4-Stream data with two pixels data per clock. The RAW video data is then converted into RGB data using the Demosaic IP, V_Gamma_Lut, V_Proc_SS CSC IPs, two pixels at a time.

RGB data is then fed to the Video Test Pattern Generator IP (V-TPG). The TPG is available in the design to act as an alternate source of video in case no MIPI CSI-2 video source is present. The TPG (in pass-through mode) sends video packets across the AXI4-Stream data in dual pixel per beat mode to an AXI4-Stream broadcaster.

The broadcaster is used to broadcast the stream to the MIPI DSI TX Subsystem or HDMI TX Subsystem to be displayed. The HDMI TX Subsystem is available as an alternative if a MIPI DSI-compliant display panel is not available. Using the GPIO IP, one of the destination video paths is selected. The GPIO enables the TREADY signal in the selected path. If the MIPI DSI TX Subsystem path is chosen, the video is passed through a video processing subsystem configured as a Scaler. This is required as the MIPI DSI Panel works on a fixed resolution of 1920x1200. All videos must either be up scaled (480p, 720p, 1080p) or downscaled (4K) to 1920x1200 resolution for the MIPI DSI display panel.

The entire system runs at 150 MHz video clock frequency.

Note: You must have the hardware evaluation license for the following IPs to build the complete design:

- MIPI CSI-2 RX Subsystem
- MIPI DSI TX Subsystem
- HDMI TX Subsystem
- Test pattern generator

Setup Details

This section lists the prerequisites and setup required for ZCU102 based application example design.

Prerequisites

Prior to working on the rest of instructions in this section, ensure that you have the following hardware available with you.

- Zynq® UltraScale+™ ZCU102 Rev 1.0 board and power supply
- JTAG USB Platform cable or USB cable Type A to micro - B
- USB cable Type A to micro-B for USB-UART
- HDMI cable
- HDMI Monitor supporting 4K@30 fps with at least 12 bpc color depth
- AUOS DSI Display panel (B101UAN01.7_H/W 1A) with ribbon cable
- LI-IMX274MIPI-FMC Camera sensor module
- Host PC (to program and communicate with the program via UART)

Hardware Setup

1. Connect the ribbon cable to the AUO display panel.

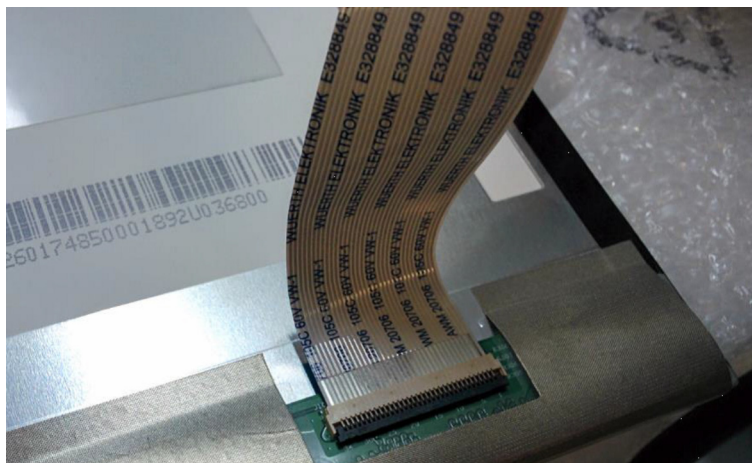

Figure 5-2: Connect Ribbon Cable to AUO Display Panel

2. Connect the other end of the ribbon cable to the LI-IMX274MIPI-FMC Camera sensor module.



Figure 5-3: LI-IMX274MIPI-FMC Camera Sensor Module

3. Setup the hardware connections:
 - a. Mount the LI-IMX274MIPI-FMC Camera sensor module on the ZCU102 board HPC0 FMC Slot.

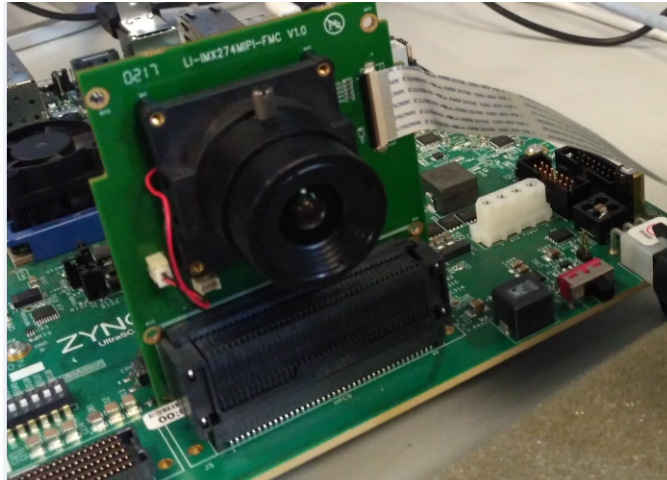

Figure 5-4: LI-IMX274MIPI-FMC Camera Sensor Module

- b. Connect the HDMI cable to the ZCU102 HDMI port (top port) (Figure 5-4).
- c. Connect the other end of the HDMI cable to the HDMI monitor.
- d. Switch on the HDMI monitor, and select HDMI as input source.
- e. Connect USB-UART type A to micro USB cable from the host PC to the UART micro USB port of board.
- f. Connect the USB-JTAG programming cable from host PC to JTAG micro USB port ofboard.
- g. Ensure the board switches and jumpers are in position as shown in Figure 5-5. Ensure that all SW6 switches are set to the ON position to allow programming from JTAG.
- h. Connect the USB UART and JTAG programming cables to the Windows host computer where xsdb and hw_server is running.

4. Connect the power supply cable and turn on the ZCU102 board.

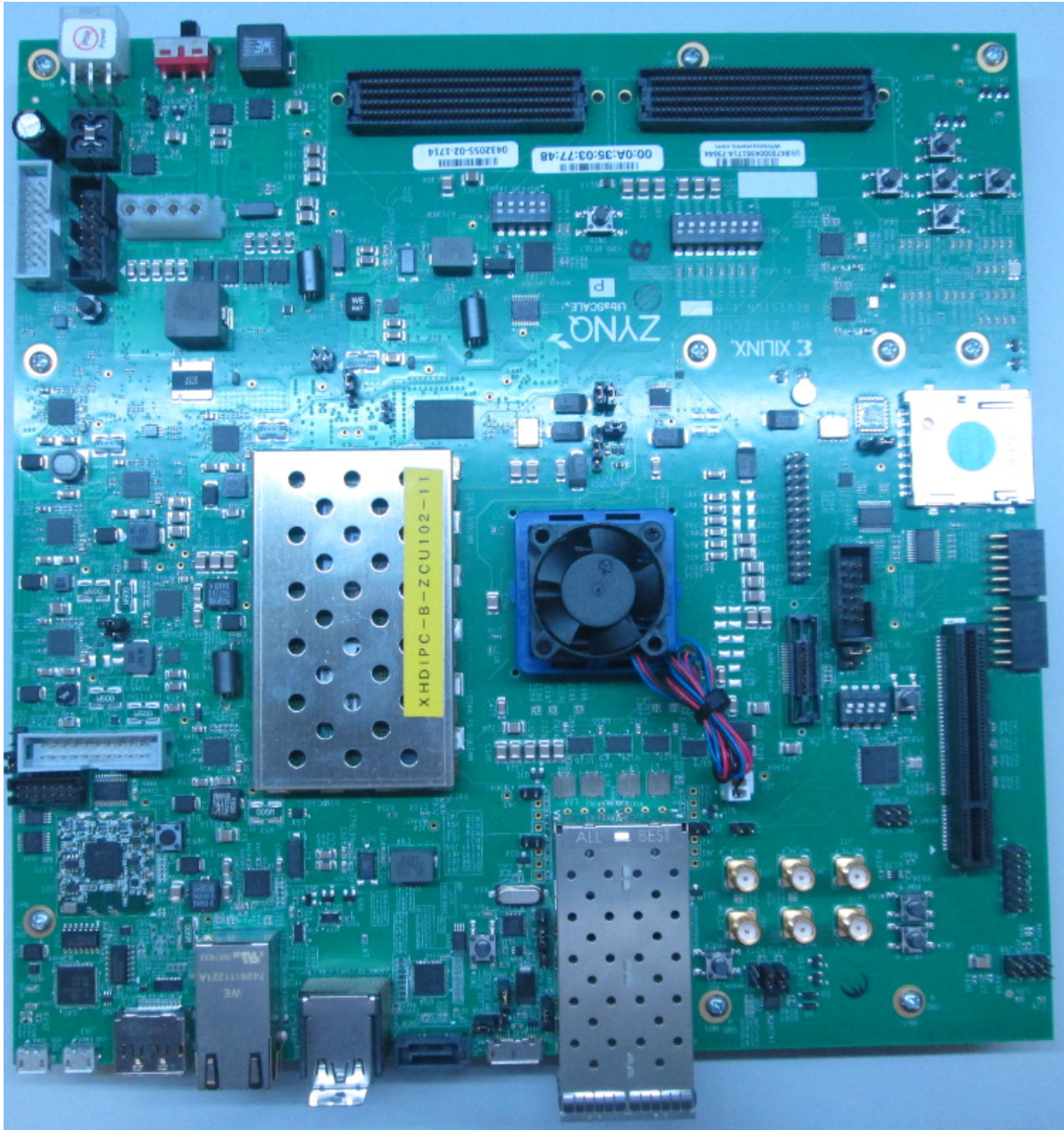

Figure 5-5: ZCU 102 Board

5. Start a Hyper Terminal program on the host PC with the following settings:
 - Baud rate: 115200
 - Data Bits: 8
 - Parity: None
 - Stop Bits: 1

- Flow Control: None

Note: Use the focus ring around the camera lens to adjust focus if the image is out of focus or blurred while running the application.

SP701 Application Example Design Overview:

The Application Example Design demonstrates the usage of the MIPI CSI-2 RX Subsystem and MIPI DSI TX Subsystem on Spartan -7 SP701 board. On the capture path, the system receives images captured by pcam-5c image sensor. Processed images are displayed on either the HDMI monitor or MIPI DSI Display.

The MIPI CSI-2 RX Subsystem decodes, processes video data and presents on AXI4-Stream data with two pixels data per clock. The RAW video data is then converted into RGB data using the Demosaic IP two pixels at a time. The AXI4-Stream data is sent to the AXI Switch that broadcast the stream to MIPI DSI TX Subsystem or the AXI4 Stream to Video Out Subsystem depending on the user selection.

The Video Test Pattern Generator IP (V-TPG) is available in the HDMI Path to act as an alternate source of video in case no MIPI CSI-2 video source is present. The TPG (in pass-through mode) sends video packets across to the AXI4 Stream to Video Out.

If the MIPI DSI TX Subsystem path is chosen, the video is passed through a video processing subsystem configured as a Scaler. This is required as the MIPI DSI Panel works on a fixed resolution of 1920x1200. The video must be up scaled (1080p) to 1920x1200 resolution for the MIPI DSI display panel.

Setup Details

This section lists the prerequisites and setup required for SP701 board based application example design.

Prerequisites

Prior to working on the rest of instructions in this section, ensure that you have the following hardware available with you.

- Spartan-7 SP701 board and power supply
- JTAG USB Platform cable or USB cable Type A to micro - B
- HDMI cable
- HDMI Monitor

- AUOS DSI Display panel (B101UAN01.7_H/W 1A) with ribbon cable
- Pcam-5C Camera sensor module
- Host PC (to program and communicate with the program via UART)

Hardware Setup

1. Connect the ribbon cable to the AUO display panel.

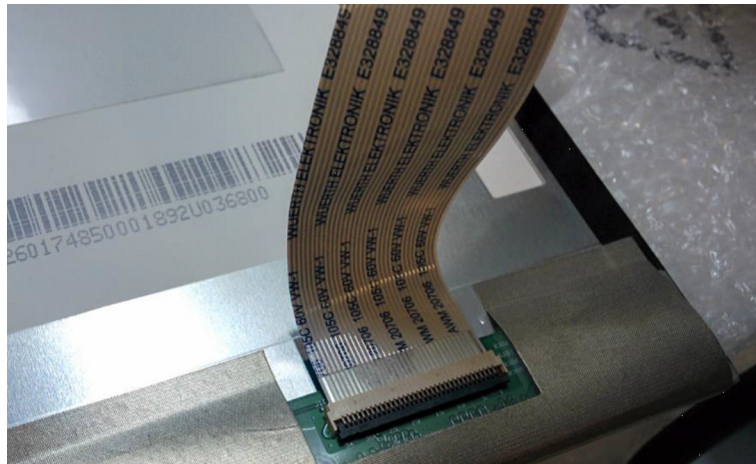

Figure 5-6: Connect Ribbon Cable to AUO Display Panel

2. Connect the other end of the ribbon cable to the Pcam-5C Camera sensor module.



Figure 5-7: PCAM5C Sensor Camera Module

3. Setup the hardware connections:

- a. Connect PCAM 5C Camera Sensor module to the SP701 board "" MIPI CSI slot.
- b. Connect the HDMI cable to the SP701 HDMI OUT port (Figure 5-8).
- c. Connect the other end of the HDMI cable to the HDMI monitor.
- d. Switch on the HDMI monitor, and select HDMI as input source.
- e. Connect the USB-JTAG programming cable from host PC to JTAG micro USB port of board .
- f. Ensure the board switches and jumpers are in position as shown in the following figure.

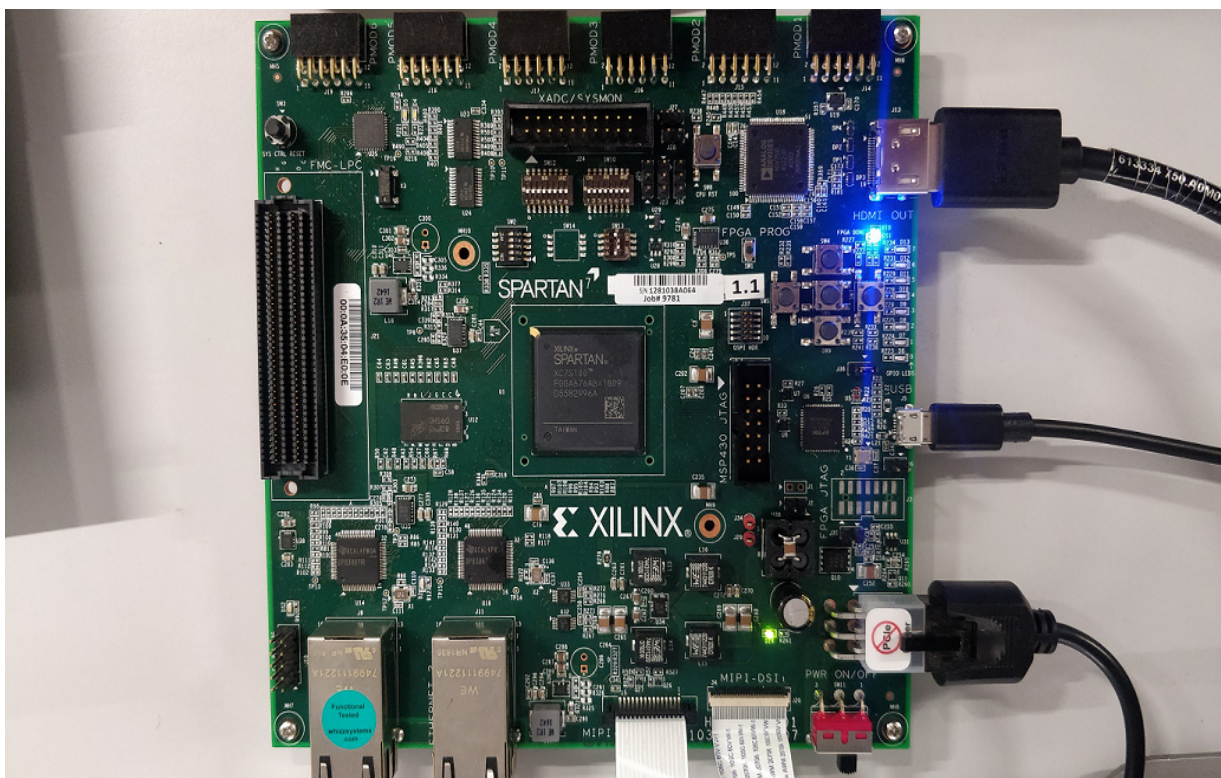

Figure 5-8: SP701 Board

- g. Ensure that all SW6 switches are set to the ON position to allow programming from JTAG.
 - h. Connect the USB UART and JTAG programming cables to the Windows host computer where xsdb and hw_server is running.
4. Connect the power supply cable and turn on the SP701 board.
 5. Start a Hyper Terminal program on the host PC with the following settings:
 - Baud rate: 9600
 - Data Bits: 8
 - Parity: None

- Stop Bits: 1
- Flow Control: None

Running the Design on the Hardware



IMPORTANT: Before running the design on the Hardware, you need to build the project and generate the required bit/elf files. See [Implementing the Example Design](#) for more details.

1. Connect the JTAG cable and USB-UART cable to the board.
2. Go to Imports directory under the Application Example Design project

Example:

```
E:/myip/myip_ex/imports:
```

3. Launch the Xilinx System Debugger by selecting **Start > All Programs > Xilinx DesignTools > Vivado 2019.2 > Vivado 2019.2 Tcl Shell**.
4. Invoke Xilinx System Debugger.

```
(xsdb)Vivado% xsdb
```

5. Run the following command in XSDB prompt to program FPGA and to execute the application.

```
xsdb% source xsdb.tcl
```

Note: For SP701 based example design, source `SP701_xsdb.tcl` in the XSDB prompt.

6. For ZCU102 board based example design, to observe the results, start a Hyper Terminal program on the host PC and configure its serial port (Interface 0) to 115200 baud rate with the default configuration. Ensure that the UART cable is connected to the board and the PC. The UART console displays a menu in the console. You are prompted for design related inputs.
 - a. Initially, the application asks you if the camera sensor and display panel are connected. Enter either **y** or **n**.

Note: If you answer **n**, it is assumed that the camera or the DSI panel or both are not available. The system displays the Camera sensor is set as Disconnected, and/or the DSI Display panel is set as Disconnected error message on the console.
 - b. Under the Main Menu, you are prompted for video source, display device and resolution details.
 - Press **s** to select the Sensor as video source and show live sensor data capture.
 - Press **t** to select the Video Test Pattern generator as the video source and will show rainbow pattern on screen.

- Press h to switch the display to HDMI monitor if not already displayed.
- Press d to switch the display to DSI panel.
- Press r to bring up the resolution menu.

Note: Selecting an invalid option prompts an Unknown option error message on the console. All resolutions support only four (4) lanes. The supported lane and other pipeline configurations are listed under the Current Pipe Configuration section displayed on the console.

7. For SP701 board based Example Design, to observe the results, start a Hyper Terminal program on the host PC and configure its serial port (Interface 0) to 9600 baud rate with the default configuration. Ensure that the UART cable is connected to the board and the PC. The UART console displays a menu in the console. Under the Main Menu, you are prompted to select the preferred output.
 - a. Press 1 to select the display to DSI Panel
 - b. Press 2 to switch the display to HDMI Monitor

Note: Selecting an invalid option prompts an Unknown option error message on the console. All resolutions support only four (4) lanes. The supported lane and other pipeline configurations are listed under the Current Pipe Configuration section displayed on the console.

Implementing the Example Design

1. Open the Vivado Design Suite.

The Vivado IDE Getting Started page contains links to open or create projects and to view documentation.

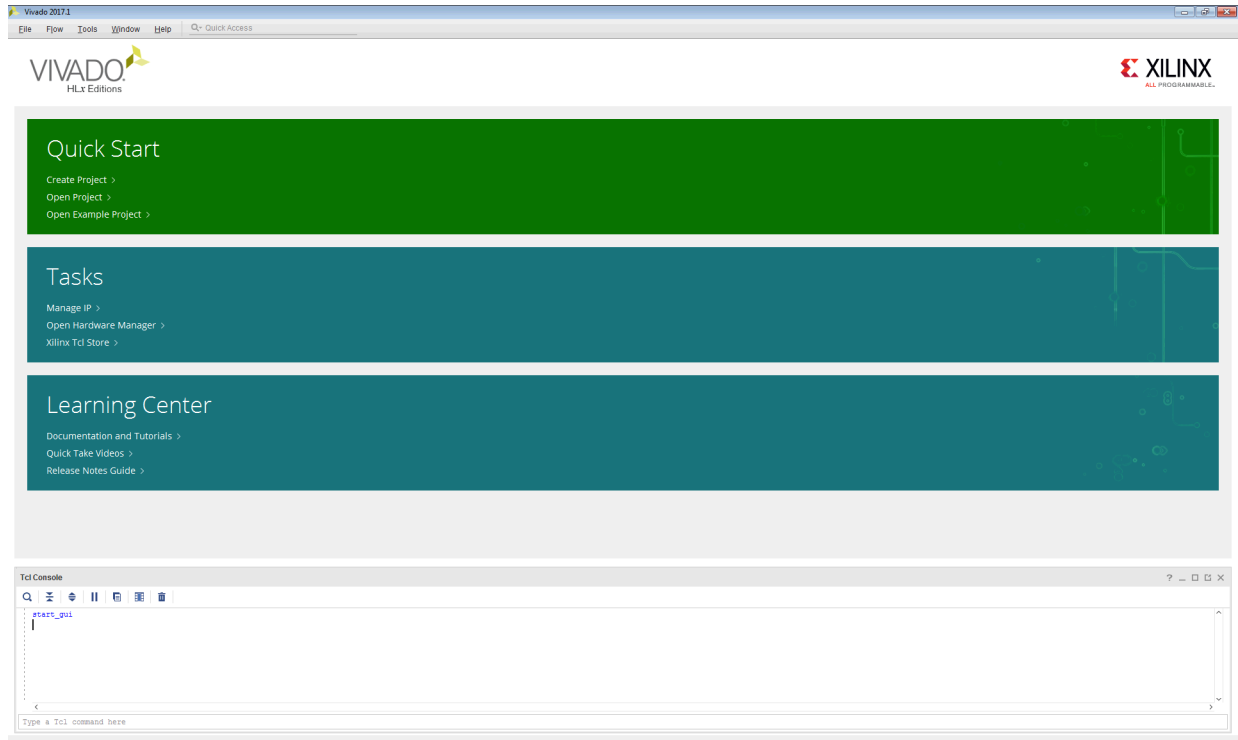

Figure 5-9: Vivado IDE - Getting Started

2. In the Getting Started page, click **Create Project** to start the New Project wizard.
3. In the Project Name page, name the new project and enter the project location. Make sure to check the **Create project subdirectory** option and click **Next**.
4. In the Project Type page, specify the type of project to create as RTL Project, make sure to uncheck the **Do not specify sources at this time** option, and click **Next**.
5. In the Add Sources page, click **Next**.
6. In the Add Existing IP (optional) dialog box, click **Next**.
7. In the Add Constraints (optional) dialog box, click **Next**.

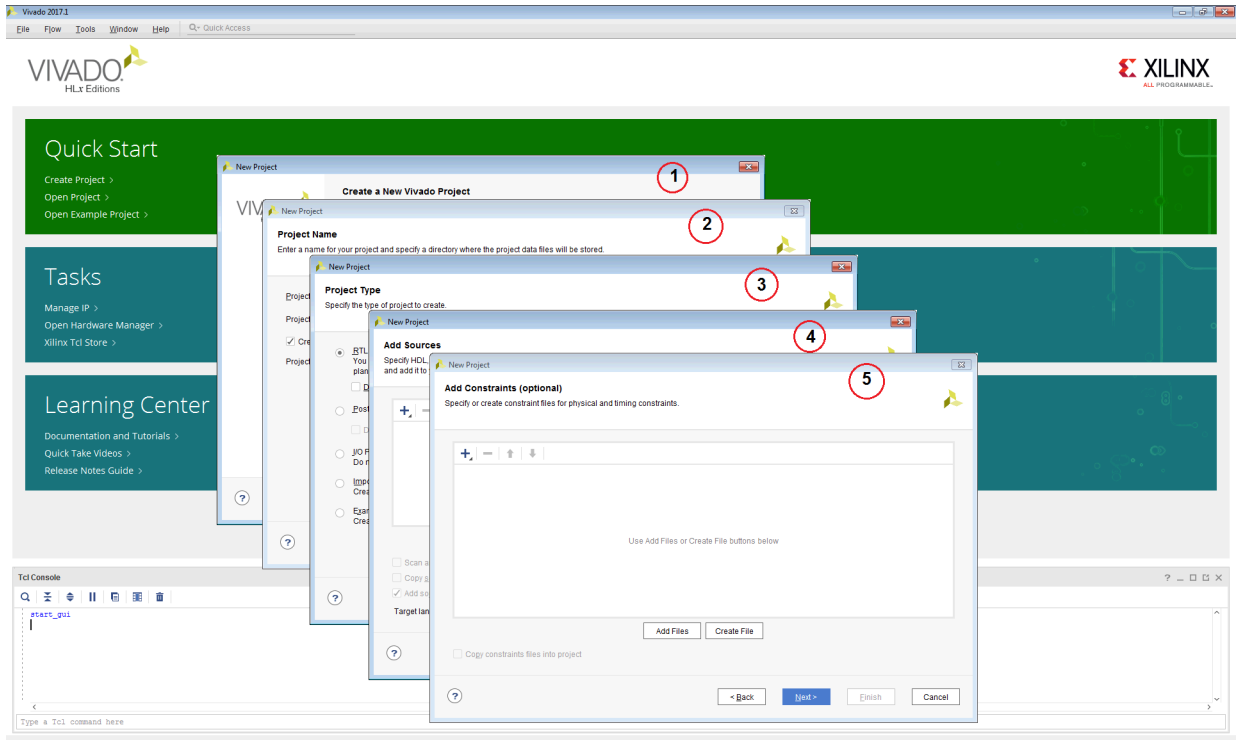

Figure 5-10: Vivado IDE - Create New Project

- In the Default Part dialog box, click **Boards** to specify the board for the target device (ZCU102 and SP701 supported). Then click **Next**.

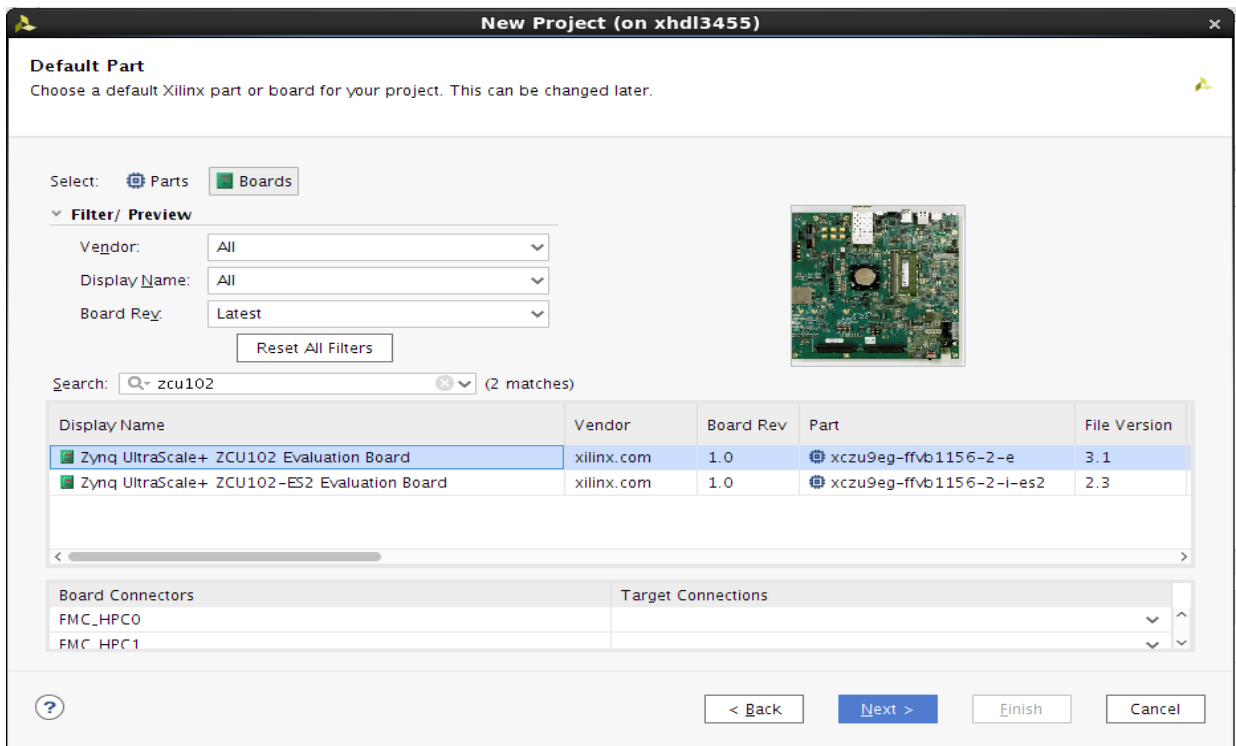

Figure 5-11: Vivado IDE - Default Part

- Review the New Project Summary page. Verify that the data appears as expected, per the steps above, and click **Finish**.

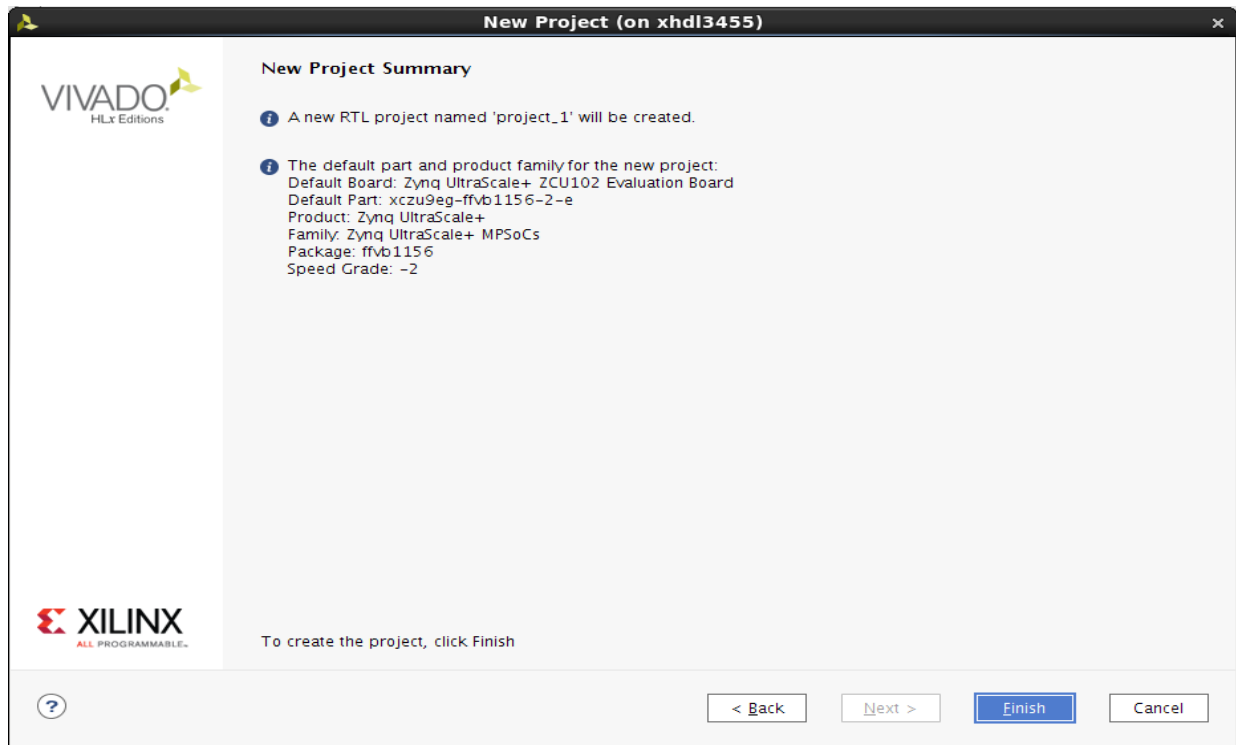

Figure 5-12: Vivado IDE - New Project Summary

- Click **IP Catalog** and select MIPI CSI-2 RX Subsystem under Video Connectivity, then double click on it.

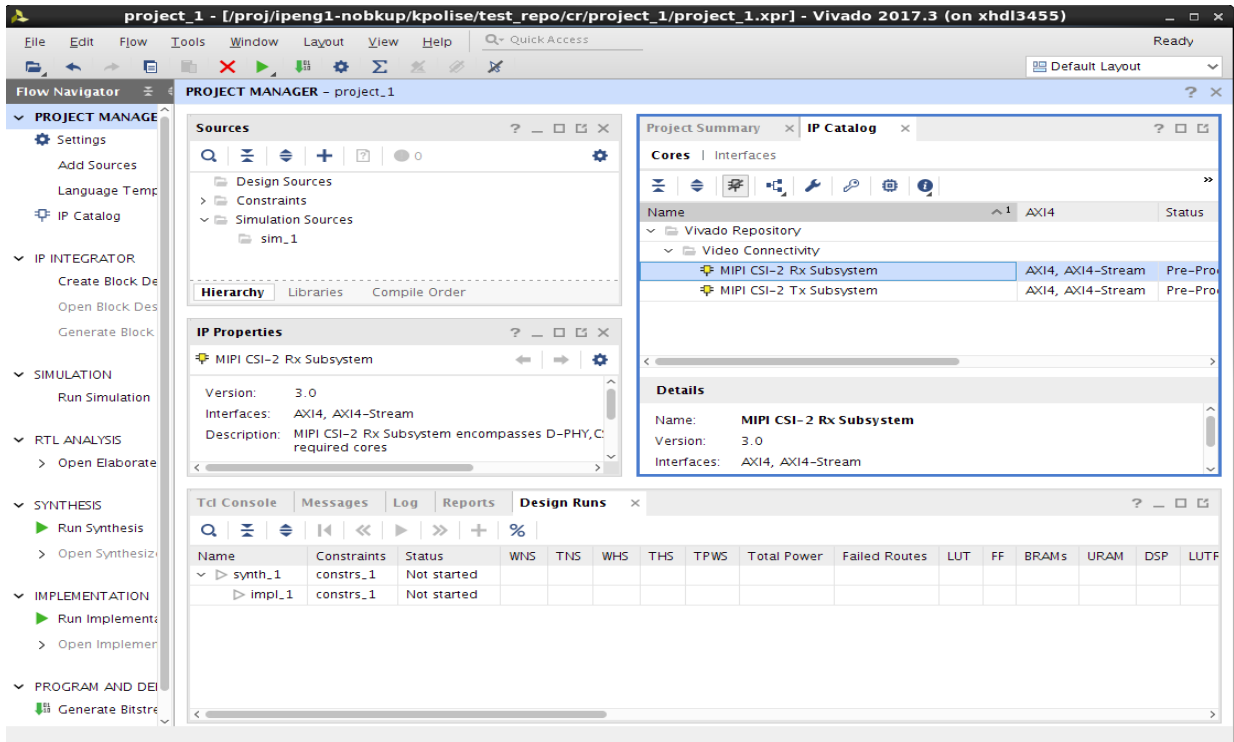

Figure 5-13: Vivado IDE - IP Catalog

- For the Application Example Design flow, IP configuration is based on options selected in 'Application Example Design' tab.
 - You can rename the IP component name.
11. Configure MIPI CSI-2 RX Subsystem 'Application Example Design' tab to select ZCU102 or SP701 based design, then click **OK**.

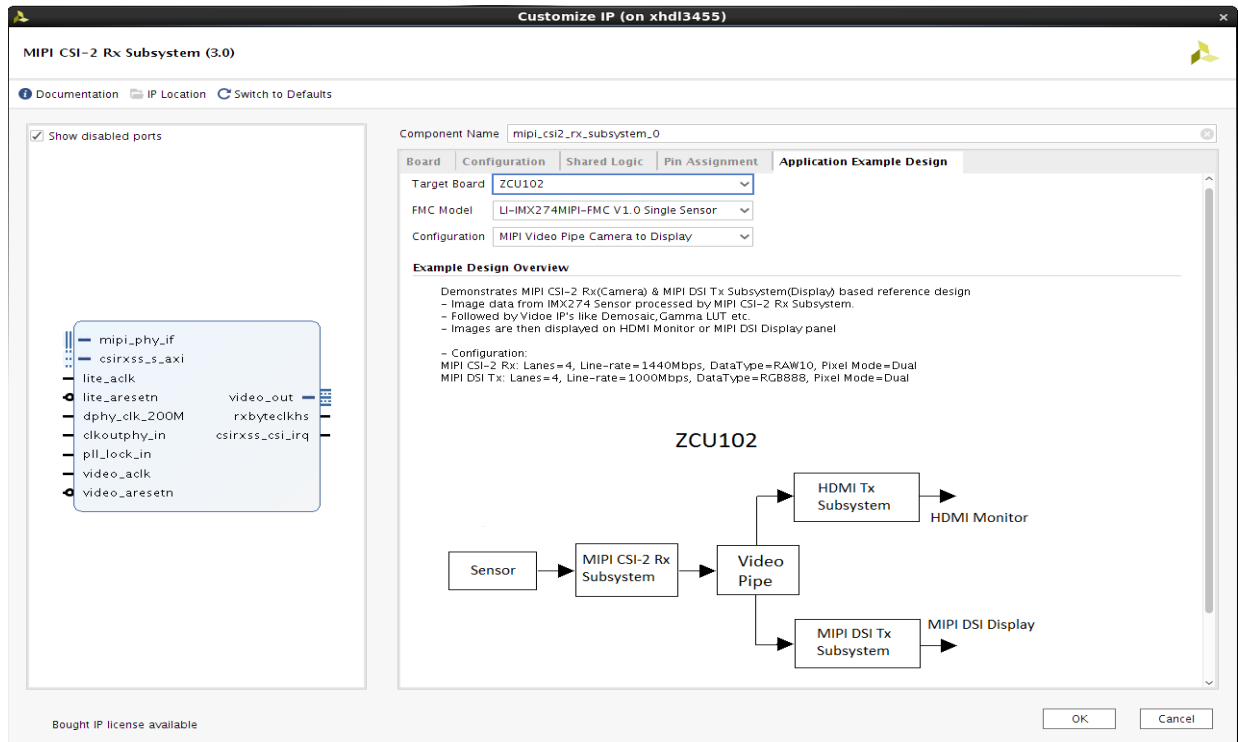

Figure 5-14: Vivado IDE - Customize IP

The **Generate Output Products** dialog box appears.

Click **Generate**. You may optionally click **Skip** if you want to skip generating the output products.

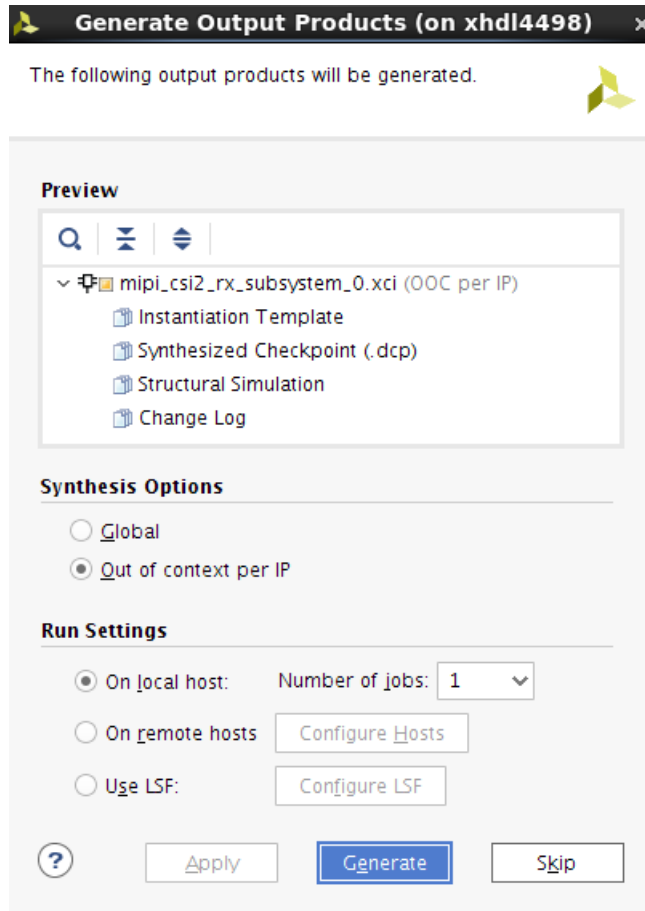

Figure 5-15: Vivado IDE - Generate Output Products

12. Right click on the MIPI CSI-2 Rx Subsystem component under Design source, and click **Open IP Example Design**.

Note: As this step involves the generation of complete system involving multiple subsystems, it would take some time to completely build the design.

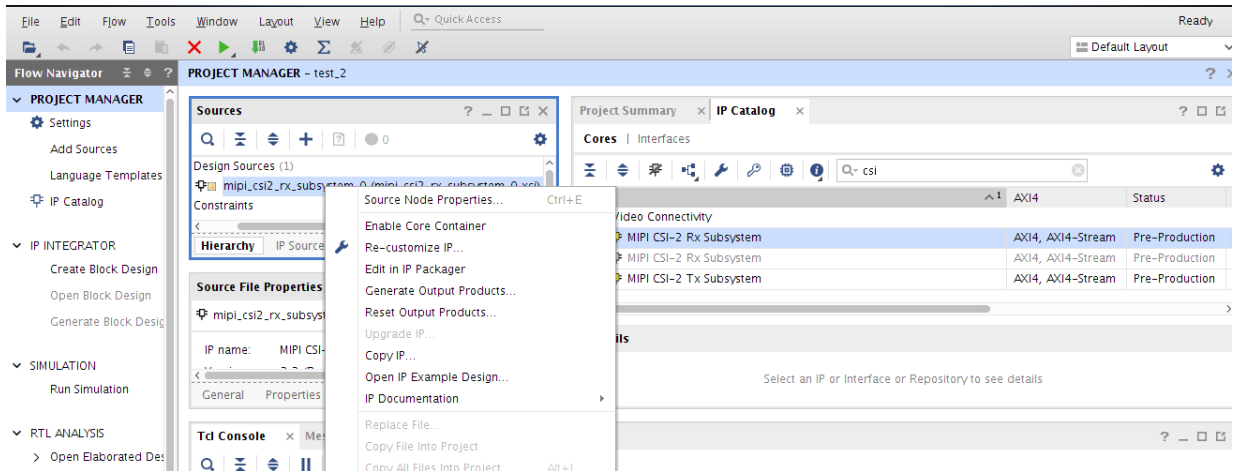

Figure 5-16: Vivado IDE - Open IP Example Design

13. Choose the target project location, then click **OK**.

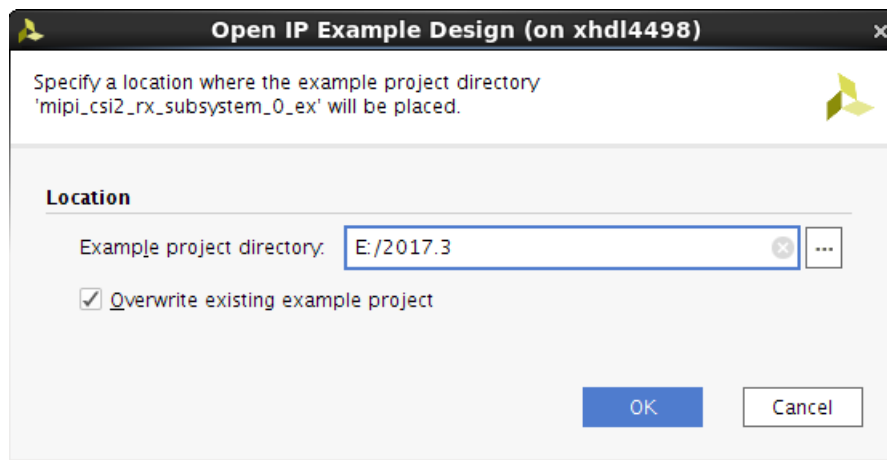

Figure 5-17: Open IP Example Design - Select Example Project Directory

- The overall system IPI block diagram of the ZCU102 or SP701 based application example design is generated depending on the GUI option selected. You may choose to Run Synthesis, Implementation, or Generate Bitstream.

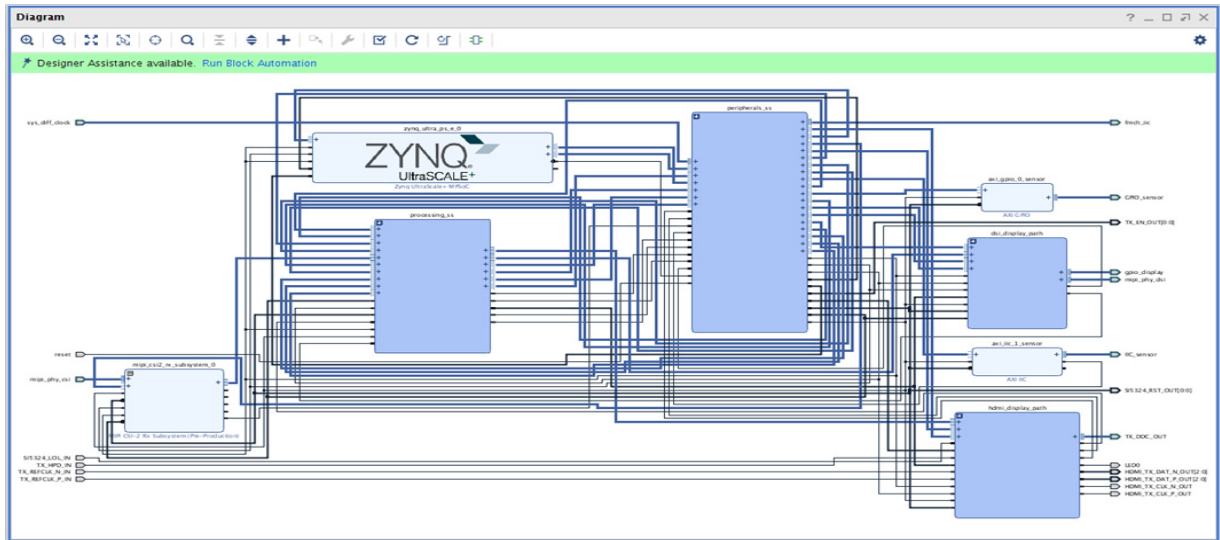

Figure 5-18: Overall System IPI Block Diagram for ZCU12-based Example Design

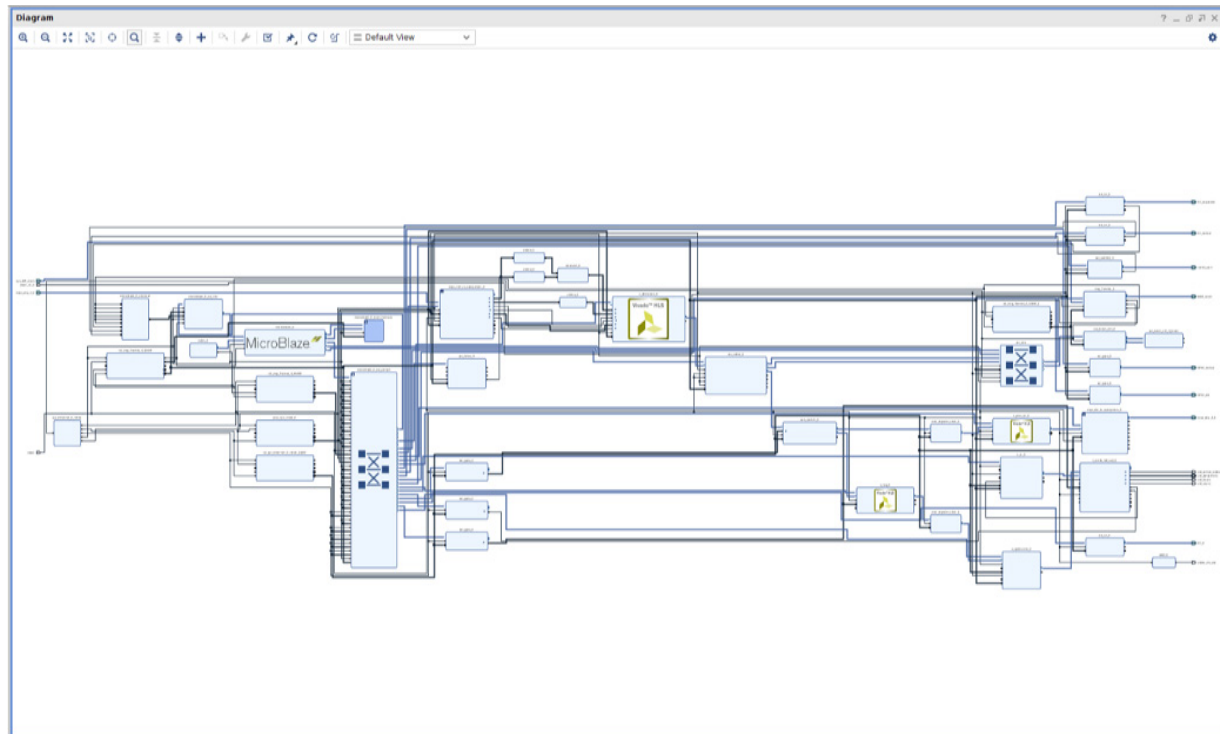

Figure 5-19: Overall System IPI Block Diagram for SP701-based Example Design

Vitis Software Platform flow

This section describes the steps to build the software application project using the Vitis software platform.

The C application files for the example design are available in the path / <example_design>/SW/xmipi_app/executable/src/ and the executable application is available under /<example_design>/SW/xmipi_app/executable/Debug/ in the example design folder.

Steps to build software application using the Vitis software platform:

1. Launch the Vitis software platform by using the command 'vitis'. A dialog box appears , enter the workspace path.

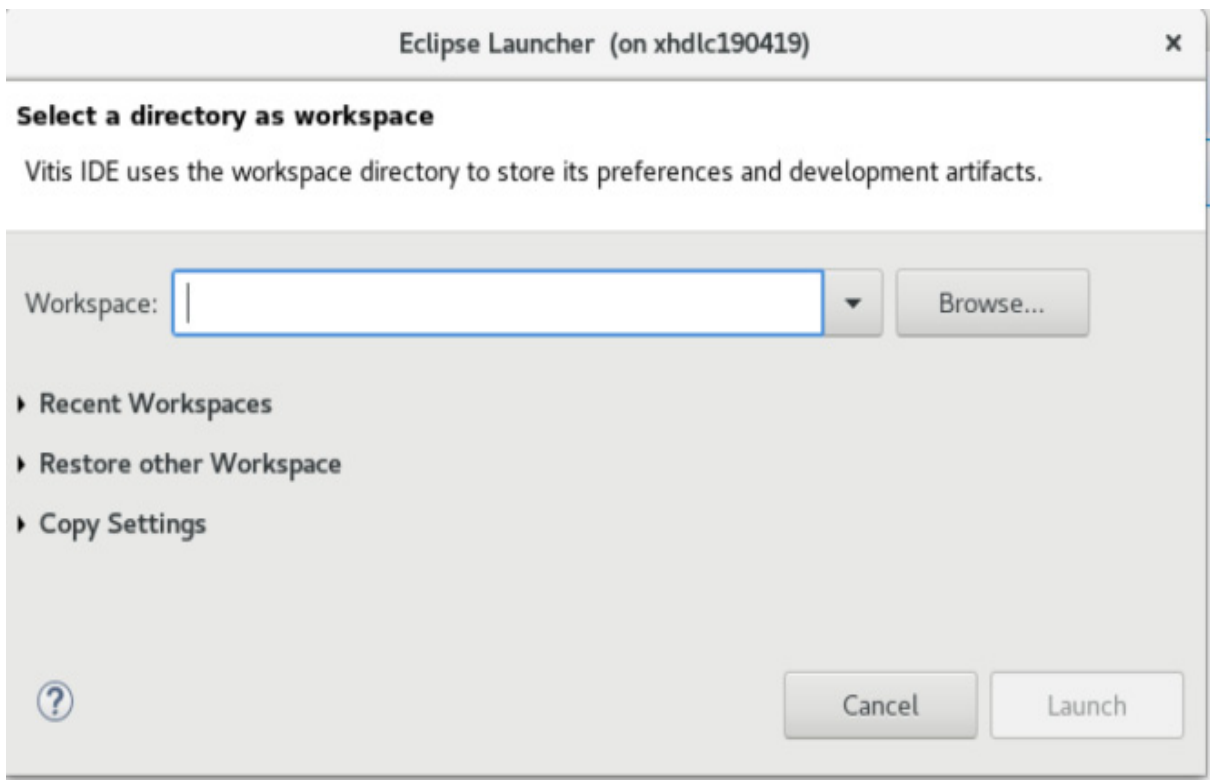

Figure 5-20: Launching the Vitis Software Platform

2. Browse to the current workspace. For the MIPI CSI2 RX example design, browse to / <example_design>/SW/xmipi_app path in the example design folder.

- The workspace opens with system project `executable_system` and application project (`executable`).

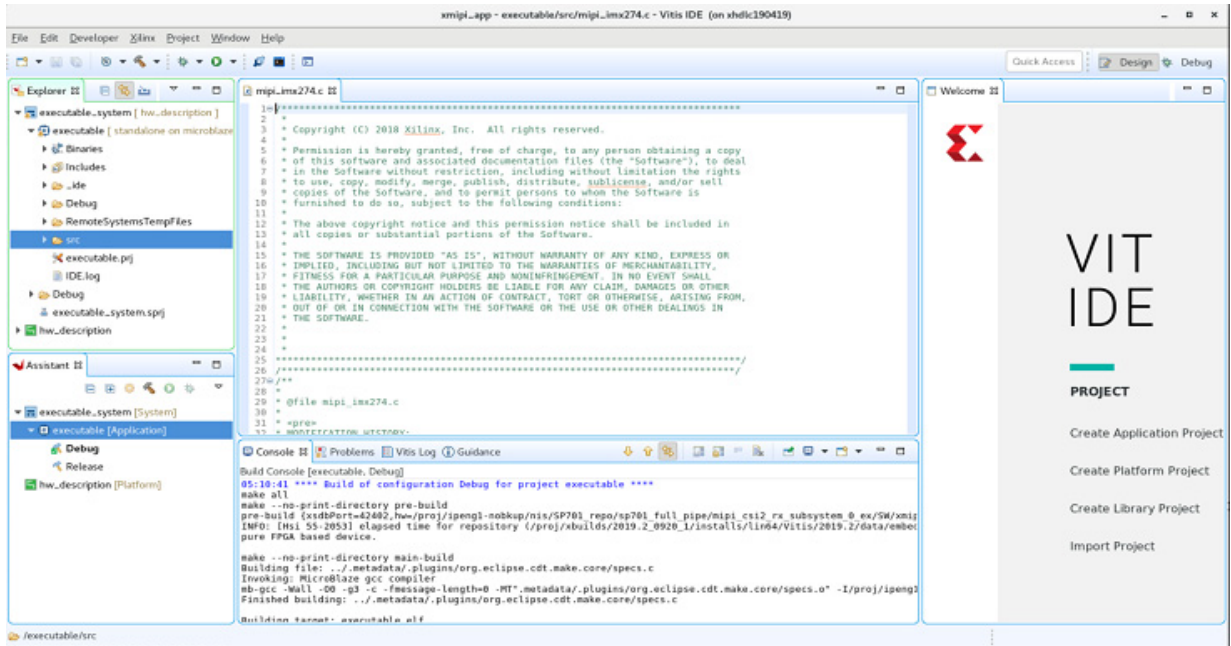

Figure 5-21: Vitis GUI

- The Application project has `src` and `Debug` folders containing the application C files and the executable application. The C files can be edited if required.
- To build the application, click **Project > Build project**.
- The new executable application is available in the `/<example_design>/SW/xmipi_app/executable/Debug/` folder.

Note: In case the application project GUI has not opened as shown in Figure 5-21. Click the **Restore** button on the top right corner of the Vitis software platform GUI.

Known Issues

- Short duration of flickering appears while changing available options such as resolution change from the Application Menu.
- Sometimes, the MIPI DSI Display goes blank when you switch from HDMI to DSI.

Verification, Compliance, and Interoperability

The MIPI CSI-2 RX Subsystem has been verified using both simulation and hardware testing. A highly parameterizable transaction-based simulation test suite has been used to verify the subsystem. The tests include:

- Different lane combinations and line rates
- High-Speed Data reception with short/long packets, different virtual channels and different data types.
- All possible interleaving cases (data type and virtual channel)
- All possible output pixel, data type combinations.
- Recovery from error conditions
- Register read and write access

Hardware Validation

The MIPI CSI-2 RX Subsystem is tested in hardware for functionality, performance, and reliability using Xilinx® evaluation platforms. The MIPI CSI-2 RX Subsystem verification test suites for all possible modules are continuously being updated to increase test coverage across the range of possible parameters for each individual module.

A series of MIPI CSI-2 RX Subsystem test scenarios are validated using the Xilinx development boards listed in [Table A-1](#). These boards permit the prototyping of system designs where the MIPI CSI-2 RX Subsystem processes different short/long packets received on serial lines.

Table A-1: Xilinx Development Board

Target Family	Evaluation Board	Characterization Board
Zynq® UltraScale+™ MPSoC	ZCU102	N/A
Zynq-7000 SoC	ZC702	N/A
Spartan-7 FPGA	SP701	N/A

Xilinx 7 series FPGA devices do not have a native MIPI IOB support. You will have to target either the HR bank I/O or the HP bank I/O for the MIPI IP implementation. For more information on MIPI IOB compliant solution and guidance, refer *D-PHY Solutions* (XAPP894) [Ref 14].

A series of interoperability test scenarios listed in [Table A-2](#) and [Table A-3](#) are validated using different core configurations and resolutions. All ZCU102 designs use the native MIPI IO available in the UltraScale+ FPGA.

Table A-2: Interoperability Testing UltraScale+ Device

Sensor	Board/Device	Tested Configuration	Resolution
Omnivision OV13850	ZCU102/ xczu9eg-ffvb1156-2-e	1200 Mb/s 1, 2, 4 Lanes RAW8, RAW10, RAW12	480p@60fps 720p@60fps 1080p@60fps 4k@30fps
Sony IMX274	ZCU102/ xczu9eg-ffvb1156-2-e	1440 Mb/s 4 Lanes RAW10, RAW12	All supported modes by sensor
Sony IMX224	ZCU102/ xczu9eg-ffvb1156-2-e	149 Mb/s, 594 Mb/s 1, 2, 4 Lanes RAW10, RAW12	All-pixel (QVGA) and Window cropping modes
ON Semi AR0330	ZCU102/ xczu9eg-ffvb1156-2-e	490 Mb/s 4 Lanes RAW10	480p@60fps 720p@60fps 1080p@60fps

All Xilinx 7 series FPGA interop designs use the external Meticom (MC20901) based solution which implements MIPI D-PHY IO.

Table A-3: Interoperability Testing with Xilinx 7 Series FPGA Devices

Sensor	Board/Device	Tested Configuration	Calibration Mode	Resolution
Sony IMX274	ZC702/ xc7z020clg484-1	576 Mb/s 4 Lanes RAW10	Auto Enable 300 MHz clock for IDELAYCTRL=false	1080p@60fps
Sony IMX274	ZC702/ xc7z020clg484-1	1152 Mb/s 2 Lanes RAW10	Auto Enable 300 MHz clock for IDELAYCTRL=true	1080p@60fps
ON Semi AR0330	KC705/ xc7k325tffg900-2	490 Mb/s 4 Lanes RAW10	None	480p@60fps 720p@60fps 1080p@60fps 2304x1296@60fps

Table A-3: Interoperability Testing with Xilinx 7 Series FPGA Devices

Sensor	Board/Device	Tested Configuration	Calibration Mode	Resolution
ON Semi AR0330	KC705/ xc7k325tffg900-2	588 Mb/s 4 Lanes RAW12	None	1080p@60fps 2304x1296@60fps
ON Semi AR0330	ZC702/ xc7z020clg484-1	490 Mb/s 4 Lanes RAW10	None	480p@60fps

All Xilinx 7 series FPGA loopback designs use the XM107 [Ref 18] loopback card.

Table A-4: Loopback Testing with Xilinx 7 Series FPGA Devices

Board/Device	Line Rate	Lanes	Calibration Mode	Clock Selection (C_EN_CLK300M)
AC701/ xc7a200tfbg676-2	1250	4	Auto	False
KC705/ xc7k325tffg900-2	1250	4	Auto	False
VC709/ xc7vx690tffg1761-2	1250	4	Auto	False
ZC702/ xc7z020clg484-1	928	4	Auto	True
ZC706/ xc7z045ffg900-2	1250	4	Auto	True

Following board guidelines such as equal trace lengths helps in achieving higher line rates. For PCB guidelines refer to *UltraScale Architecture PCB Design User Guide* (UG583) [Ref 16].

Debugging

This appendix includes details about resources available on the Xilinx Support website and debugging tools.

TIP: *If the IP generation halts with an error, there might be a license issue. See [License Checkers in Chapter 1](#) for more details.*

Finding Help on Xilinx.com

To help in the design and debug process when using the MIPI CSI-2 Receiver Subsystem, the [Xilinx Support web page](#) contains key resources such as product documentation, release notes, answer records, information about known issues, and links for obtaining further product support.

Documentation

This product guide is the main document associated with the MIPI CSI-2 Receiver Subsystem. This guide, along with documentation related to all products that aid in the design process, can be found on the [Xilinx Support web page](#) or by using the Xilinx Documentation Navigator.

Download the Xilinx Documentation Navigator from the [Downloads page](#). For more information about this tool and the features available, open the online help after installation.

Answer Records

Answer Records include information about commonly encountered problems, helpful information on how to resolve these problems, and any known issues with a Xilinx product. Answer Records are created and maintained daily ensuring that users have access to the most accurate information available.

Answer Records for this subsystem can be located by using the Search Support box on the main [Xilinx support web page](#). To maximize your search results, use proper keywords such as:

- Product name
- Tool message(s)
- Summary of the issue encountered

A filter search is available after results are returned to further target the results.

For the MIPI CSI-2 Receiver Subsystem Master Answer Record see Xilinx Answer [65242](#).

Technical Support

Xilinx provides technical support at the [Xilinx Support web page](#) for this IP product when used as described in the product documentation. Xilinx cannot guarantee timing, functionality, or support if you do any of the following:

- Implement the solution in devices that are not defined in the documentation.
- Customize the solution beyond that allowed in the product documentation.
- Change any section of the design labeled DO NOT MODIFY.

To contact Xilinx Technical Support, navigate to the [Xilinx Support web page](#).

Debug Tools

There are many tools available to address MIPI CSI-2 Receiver Subsystem design issues. It is important to know which tools are useful for debugging various situations.

Vivado Design Suite Debug Feature

The Vivado® Design Suite debug feature inserts logic analyzer and virtual I/O cores directly into your design. The debug feature also allows you to set trigger conditions to capture application and integrated block port signals in hardware. Captured signals can then be analyzed. This feature in the Vivado IDE is used for logic debugging and validation of a design running in Xilinx devices.

The Vivado logic analyzer is used with the logic debug IP cores, including:

- ILA 2.0 (and later versions)
- VIO 2.0 (and later versions)

See the *Vivado Design Suite User Guide: Programming and Debugging* (UG908) [\[Ref 12\]](#).

Hardware Debug

Hardware issues can range from link bring-up to problems seen after hours of testing. This section provides debug steps for common issues. The Vivado debug feature is a valuable resource to use in hardware debug. The signal names mentioned in the following individual sections can be probed using the debug feature for debugging the specific problems.

General Checks

- Ensure MIPI DPHY and MIPI CSI-2 RX Controller cores are in the enable state by reading the registers.
- Ensure Incorrect Lane Configuration is not set in the MIPI CSI-2 RX Controller Interrupt Status register.
- Ensure line buffer full condition is not set in the MIPI CSI-2 RX Controller Interrupt Status register. Core setting this bit implies that the input data rate is higher than the output data rate. Consider either decreasing input data rate (DPHY Line rate) or increase output data rate (Select appropriate output pixel per Clock: Single, Dual, Quad).
- Following MIPI CSI-2 RX Controller registers can be monitored to confirm reception of data packets
 - Packet count in Core Status register
 - Data type and Byte count in Image Information registers
 - Frame received bit in Interrupt Status register
- No packets received by MIPI CSI-2 Subsystem
 - Possible causes:
 - No packets received at MIPI DPHY level itself
 - Frame end packets not received or not passed the ECC checks at MIPI CSI-2 RX Subsystem level
 - Debug instructions:
 - Verify MIPI DPHY packet count registers. If the packet counts at MIPI DPHY level are not getting reported, debug connections/paths from source to MIPI DPHY Input
 - Verify MIPI CSI-2 RX Controller interrupt status register to see if any ECC errors getting reported. If there is frequent ECC 2-bit error getting reported means some of the packets are not getting processed by MIPI CSI-2 RX Controller.
- Packets received by MIPI CSI-2 Subsystem with PPI Level Errors (like SoT Error, SoT sync Error) and/or Controller level errors (like ECC 1-bit, ECC 2-bit, CRC).

- Possible causes:
 - Lane position mismatch between source (sensor) and MIPI CSI-2 RX Subsystem.
 - Noise detected by MIPI DPHY as a valid packet
- Debug instructions:
 - Verify Lane positions of source (sensor) and MIPI CSI-2 RX Subsystem are matching. Lane0 holds first byte of the packet, Lane1 holds the next byte and so on.
 - When HS_SETTLE parameter of MIPI DPHY is not sufficient enough during LP to HS transition, MIPI DPHY may detect noise as a valid packet and when subsequently processed by MIPI CSI-2 RX Controller reports these packets are erroneous packets. Increase HS_SETTLE value either through MIPI DPHY registers or through C_HS_SETTLE_NS parameter(hidden) available in MIPI CSI-2 RX Subsystem.

For more debug information on MIPI DPHY, refer the *MIPI D-PHY LogiCORE IP Product Guide* (PG202) [Ref 3]. To debug further, capture the PPI signals using the Vivado® Logic analyzer and confirm the bytes received through source (sensor) are as expected for short and long packets.

Interface Debug

AXI4-Lite Interfaces

Read from a register that does not have all 0s as a default to verify that the interface is functional. See [Figure B-1](#) for a read timing diagram. Output `s_axi_arready` asserts when the read address is valid, and output `s_axi_rvalid` asserts when the read data/response is valid. If the interface is unresponsive, ensure that the following conditions are met:

- The `lite_aclk` inputs are connected and toggling.
- The interface is not being held in reset, and `lite_aresetn` is an active-Low reset.
- The main subsystem clocks are toggling and that the enables are also asserted.
- If the simulation has been run, verify in simulation and/or a debug feature capture that the waveform is correct for accessing the AXI4-Lite interface.

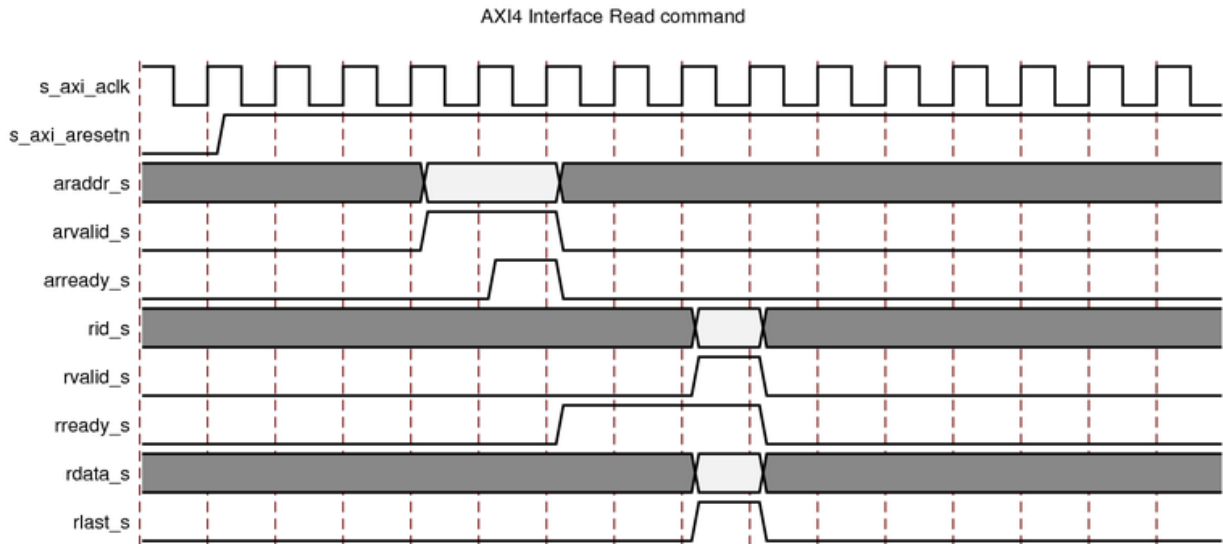

Figure B-1: AXI4-Lite Timing

AXI4-Stream Interfaces

If data is not being transmitted or received, check the following conditions:

- If transmit `<interface_name>_tready` is stuck Low following the `<interface_name>_tvalid` input being asserted, the subsystem cannot send data.
- If the receive `<interface_name>_tvalid` is stuck Low, the subsystem is not receiving data.
- Check that the `video_aclk` and `dphy_clk_200M` inputs are connected and toggling.
- Check subsystem configuration.
- Ensure "Stream line buffer full" condition not getting reported in subsystem Interrupt Status register.

Sideband Information on AXI4-Stream Interfaces

- Sideband information such as frame and line number appear on the TUSER signal of the AXI4-Stream interface.
- Start of fame, frame number, line number, word count, and data type need to be sampled by the user on the first beat of the transfer.

Note: Frame Number and Line number is an optional information set by the TX. According to the MIPI CSI-2 specification, TX can send a fixed "0" if these information is not used.
- Packet Error, ECC, and CRC need to be sampled by the user on the last beat of the transfer.

Note: The side band information are optionally sent by the sensor. Please refer to the Low Level Protocol section of MIPI CSI-2 standard v2.0 [Ref 1] for more details.

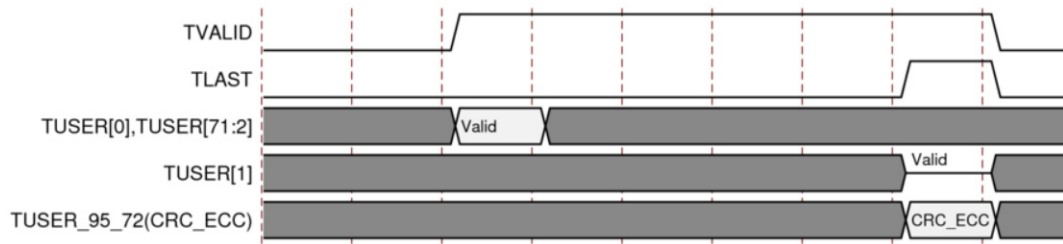

Figure B-1: Sideband Information (TUSER) Timing Diagram

Additional Resources and Legal Notices

Xilinx Resources

For support resources such as Answers, Documentation, Downloads, and Forums, see [Xilinx Support](#).

Documentation Navigator and Design Hubs

Xilinx® Documentation Navigator provides access to Xilinx documents, videos, and support resources, which you can filter and search to find information. To open the Xilinx Documentation Navigator (DocNav):

- From the Vivado® IDE, select **Help > Documentation and Tutorials**.
- On Windows, select **Start > All Programs > Xilinx Design Tools > DocNav**.
- At the Linux command prompt, enter `docnav`.

Xilinx Design Hubs provide links to documentation organized by design tasks and other topics, which you can use to learn key concepts and address frequently asked questions. To access the Design Hubs:

- In the Xilinx Documentation Navigator, click the **Design Hubs View** tab.
- On the Xilinx website, see the [Design Hubs](#) page.

Note: For more information on Documentation Navigator, see the [Documentation Navigator](#) page on the Xilinx website.

References

These documents provide supplemental material useful with this product guide:

1. MIPI Alliance Standard for Camera Serial Interface CSI-2: mipi.org/specifications/camera-interface#CSI2
2. *AXI4-Stream Video IP and System Design Guide* (UG934)
3. *MIPI D-PHY LogiCORE IP Product Guide* (PG202)
4. *AXI Interconnect LogiCORE IP Product Guide* (PG059)
5. MIPI Alliance Physical Layer Specifications, D-PHY Specification: <http://mipi.org/specifications/physical-layer#D-PHY Specification>
6. *Vivado Design Suite: AXI Reference Guide* (UG1037)
7. *Vivado Design Suite User Guide: Designing IP Subsystems using IP Integrator* (UG994)
8. *Vivado Design Suite User Guide: Designing with IP* (UG896)
9. *Vivado Design Suite User Guide: Getting Started* (UG910)
10. *Vivado Design Suite User Guide: Logic Simulation* (UG900)
11. *ISE to Vivado Design Suite Migration Guide* (UG911)
12. *Vivado Design Suite User Guide: Programming and Debugging* (UG908)
13. *Vivado Design Suite User Guide: Implementation* (UG904)
14. *D-PHY Solutions* (XAPP894)
15. *UltraScale Architecture SelectIO Resources User Guide* (UG571)
16. *UltraScale Architecture PCB Design User Guide* (UG583)
17. *LI-IMX274MIPI-FMC product page*: [LI-IMX274MIPI-FMC](#)
18. *FMC XM107 Loopback Card User Guide* (UG539)

Revision History

The following table shows the revision history for this document.

Date	Version	Revision
11/22/2019	4.1	<ul style="list-style-type: none"> Updated the register space information to include ISR and IER bits for skewcalhs. Added Application example design for SP701 board. Added CSI2 Controller Register Interface GUI option to aid resource optimization. Removed AXI IIC Option.
07/02/2019	4.0	<ul style="list-style-type: none"> Extended line rate support up to 2500 Mb/s. Added support for Deskew sequence detection at MIPI D-PHY for Ultrascale+ devices. Corrected the doc version.
05/22/2019	4.1	<ul style="list-style-type: none"> Updated the minimum video clock requirement in chapter 3. Added MIPI CSI2 RX Subsystem Latency Calculation. Corrected Data corruption for certain word counts during RAW20 data type reception.
12/05/2018	4.0	<ul style="list-style-type: none"> Updated video_out_tdest and emb_nonimg_tdest port size. Updated Table 2-5 to include VCX Frame Error register, Image Information 1, and Image Information 2 Registers for VC4 to VC15. Updated Table 1-1 to include RAW16, RAW20, and YUV 422 10 bit data types. Updated Table 4-1 User Parameters. Included new GUI options for MIPI CSI-2 Standard v2.0 compatibility in the Configuration Tab. Updated examples in the Pixel Packing for Multiple Data Types section to match the alignment described in AXI4-Stream Video IP and System Design Guide (UG934).
04/04/2018	3.0	<ul style="list-style-type: none"> ECC and CRC of long packets are made available on TUSER ports of output stream interfaces. Added support for additional 7 series devices. Added dynamic configuration capability for IDELAY Tap values in fixed calibration mode of 7 series.
10/04/2017	3.0	<ul style="list-style-type: none"> Added Application Example Design to demonstrate a full end-to-end system from capture to display on ZCU102 Added Board automation support for LI-IMX274MIPI-FMC V1.0 FMC model
04/05/2017	2.2	<ul style="list-style-type: none"> Word Count (WC) corruption limited to current packet. Additional bit in ISR added to report this conditions MIPI DPHY v3.1 changes integrated
11/30/2016	2.1	<ul style="list-style-type: none"> Added calibration mode parameters for FIXED and AUTO modes
10/05/2016	2.1	<ul style="list-style-type: none"> MIPI D-PHY 3.0 changes integrated Added 7 Series support

Date	Version	Revision
04/06/2016	2.0	<ul style="list-style-type: none">• MIPI D-PHY 2.0 changes integrated• Shared logic support• Video Format Bridge core changes to support RAW8 and User Defined Byte-based Data at all times along with the Vivado IDE selected data type.
11/18/2015	1.0	Initial Xilinx release.

Please Read: Important Legal Notices

The information disclosed to you hereunder (the "Materials") is provided solely for the selection and use of Xilinx products. To the maximum extent permitted by applicable law: (1) Materials are made available "AS IS" and with all faults, Xilinx hereby DISCLAIMS ALL WARRANTIES AND CONDITIONS, EXPRESS, IMPLIED, OR STATUTORY, INCLUDING BUT NOT LIMITED TO WARRANTIES OF MERCHANTABILITY, NON-INFRINGEMENT, OR FITNESS FOR ANY PARTICULAR PURPOSE; and (2) Xilinx shall not be liable (whether in contract or tort, including negligence, or under any other theory of liability) for any loss or damage of any kind or nature related to, arising under, or in connection with, the Materials (including your use of the Materials), including for any direct, indirect, special, incidental, or consequential loss or damage (including loss of data, profits, goodwill, or any type of loss or damage suffered as a result of any action brought by a third party) even if such damage or loss was reasonably foreseeable or Xilinx had been advised of the possibility of the same. Xilinx assumes no obligation to correct any errors contained in the Materials or to notify you of updates to the Materials or to product specifications. You may not reproduce, modify, distribute, or publicly display the Materials without prior written consent. Certain products are subject to the terms and conditions of Xilinx's limited warranty, please refer to Xilinx's Terms of Sale which can be viewed at <https://www.xilinx.com/legal.htm#tos>; IP cores may be subject to warranty and support terms contained in a license issued to you by Xilinx. Xilinx products are not designed or intended to be fail-safe or for use in any application requiring fail-safe performance; you assume sole risk and liability for use of Xilinx products in such critical applications, please refer to Xilinx's Terms of Sale which can be viewed at <https://www.xilinx.com/legal.htm#tos>.

AUTOMOTIVE APPLICATIONS DISCLAIMER

AUTOMOTIVE PRODUCTS (IDENTIFIED AS "XA" IN THE PART NUMBER) ARE NOT WARRANTED FOR USE IN THE DEPLOYMENT OF AIRBAGS OR FOR USE IN APPLICATIONS THAT AFFECT CONTROL OF A VEHICLE ("SAFETY APPLICATION") UNLESS THERE IS A SAFETY CONCEPT OR REDUNDANCY FEATURE CONSISTENT WITH THE ISO 26262 AUTOMOTIVE SAFETY STANDARD ("SAFETY DESIGN"). CUSTOMER SHALL, PRIOR TO USING OR DISTRIBUTING ANY SYSTEMS THAT INCORPORATE PRODUCTS, THOROUGHLY TEST SUCH SYSTEMS FOR SAFETY PURPOSES. USE OF PRODUCTS IN A SAFETY APPLICATION WITHOUT A SAFETY DESIGN IS FULLY AT THE RISK OF CUSTOMER, SUBJECT ONLY TO APPLICABLE LAWS AND REGULATIONS GOVERNING LIMITATIONS ON PRODUCT LIABILITY.

© Copyright 2015–2019 Xilinx, Inc. Xilinx, the Xilinx logo, Alveo, Artix, Kintex, Spartan, Versal, Virtex, Vivado, Zynq, and other designated brands included herein are trademarks of Xilinx in the United States and other countries. All other trademarks are the property of their respective owners.