

High Speed SelectIO Wizard v3.0

LogiCORE IP Product Guide

Vivado Design Suite

PG188 April 6, 2016

Table of Contents

IP Facts

Chapter 1: Overview

Feature Summary	5
Applications	6
Unsupported Features	6
Licensing and Ordering Information	6

Chapter 2: Product Specification

Performance	8
Resource Utilization	8
Port Descriptions	9

Chapter 3: Designing with the Core

General Design Guidelines	18
Clocking	18
Resets	24
Protocol Description	26

Chapter 4: Design Flow Steps

Customizing and Generating the Core	27
Output Generation	67
Constraining the Core	68
Simulation	69
Synthesis and Implementation	69

Chapter 5: Example Design

Chapter 6: Test Bench

Appendix A: Verification, Compliance, and Interoperability

Simulation	73
Hardware Testing	73

Appendix B: Migrating and Upgrading

Appendix C: Debugging

Finding Help on Xilinx.com	75
Vivado Design Suite Debug Feature	76
Hardware Debug	77

Appendix D: Additional Resources and Legal Notices

Xilinx Resources	78
References	78
Revision History	79
Please Read: Important Legal Notices	81

Introduction

The LogiCORE™ IP High Speed SelectIO™ Wizard simplifies the integration of SelectIO technology into high-speed system designs for UltraScale™ devices. This wizard creates a Verilog HDL file that instantiates and configures I/O and clocking logic such as RX_BITSLICE, TX_BITSLICE, RXTX_BITSLICE, BITSlice_CONTROL and PLL blocks present in the physical-side interface (PHY) architecture. Additionally, this core provides pin planning for the configured interface and updates the register transfer level (RTL) based on constraints.

Features

- User selectable interface type such as TX only, RX only and a mix of TX, RX and BiDir (Beta) bus directions
- For RX and BiDir (Beta) interfaces, the clock/strobe to data relationship is selectable according to the protocol setting.
- Supports serialization factor of 8 (Div4) and 4 (Div2)
- Phase-locked loop (PLL) clock source can be from either the global clock (GC) pin or from the interconnect driven through BUFG.
- Range of the user selectable PLL input clock frequencies for a given data speed
- Configurable I/O delays
- Optional register interface unit (RIU) interface and bitslip logic
- Bank selection and pin planning of all the available pins in the bank with design rule checks to meet SelectIO Logic requirement.

LogiCORE IP Facts Table	
Core Specifics	
Supported Device Family ⁽¹⁾	Virtex® UltraScale+™, Kintex® UltraScale+, Zynq® UltraScale+, Virtex UltraScale, Kintex UltraScale
Supported User Interfaces	RIU
Resources	Performance and Resource Utilization web page
Provided with Core	
Design Files	RTL
Example Design	Verilog
Test Bench	Verilog
Constraints File	Xilinx Design Constraints (XDC)
Simulation Model	Not Provided
Supported S/W Driver ⁽²⁾	N/A
Tested Design Flows⁽³⁾	
Design Entry	Vivado® Design Suite
Simulation	For supported simulators, see the Xilinx Design Tools: Release Notes Guide .
Synthesis	Vivado Synthesis
Support	
Provided by Xilinx at the Xilinx Support web page	

Notes:

1. For a complete list of supported devices, see the Vivado IP catalog.
2. Standalone driver details can be found in the software development kit (SDK) directory (<install_directory>/doc/usenglish/xilinx_drivers.htm). Linux OS and driver support information is available from the [Xilinx Wiki page](#).
3. For the supported versions of the tools, see the [Xilinx Design Tools: Release Notes Guide](#).

Overview

The High Speed SelectIO™ wizard provides the source HDL wrapper for TX, RX and RXTX bitslices in native mode. The wizard also generates LOC constraints for synthesis and implementation runs.

Feature Summary

Configuration

- Configures bus direction, RX External Clock and Data, Interface speed, PLL clock source, PLL input clock frequency, data width, bank, delay type/delay values on the TX/RX pins, data 3-state and strobe/clock 3-state
- Additionally RIU interface and Bitflip can be configured

Pin Selection

For each byte group, configures the pin selection, bus direction, signal type, data/strobe, and signal name. Allows you to choose the TX/RX/Bidir bus direction with the same configuration.

Each I/O bank contains 52 pins that can be configured as TX/RX/BIDIR. The wizard provides pin level configurability for the following;

- TX/RX/BIDIR
- Single ended/Differential
- Data/strobe/input clock/Clock forward
- Customizable signal name
- Power-on value of serial lines of TX/RXTX pins

Applications

This solution is useful for high-speed I/O interface requirements like ASIC emulation and chip-to-chip interaction and any serial protocols operating at line rates from 300 Mb/s to 1,600 Mb/s.

Unsupported Features

- Count mode (delay format)
 - Dynamic Phase Alignment (DPA) feature in the example design
 - Design Rule Check (DRC) free partner generation in the example design for a mix of bus directions in device under test (DUT).
-

Licensing and Ordering Information

This Xilinx LogiCORE™ IP module is provided at no additional cost with the Xilinx Vivado® Design Suite under the terms of the [Xilinx End User License](#). Information about this and other Xilinx LogiCORE IP modules is available at the [Xilinx Intellectual Property](#) page. For information about pricing and availability of other Xilinx LogiCORE IP modules and tools, contact your [local Xilinx sales representative](#).

Product Specification

Each I/O bank in UltraScale™ devices contains 52 pins that can be used for input, output, or bidirectional. The High Speed SelectIO™ Wizard provides various options to generate a wrapper using TX_BITSLICE, RX_BITSLICE, RXTX_BITSLICE, and BITSlice_CONTROL for the user selected configuration in native mode. This wizard also configures clocking circuitry using PLL. A representative design using TX_BITSLICE, RX_BITSLICE, RXTX_BITSLICE and BITSlice_CONTROL is shown in Figure 2-1.

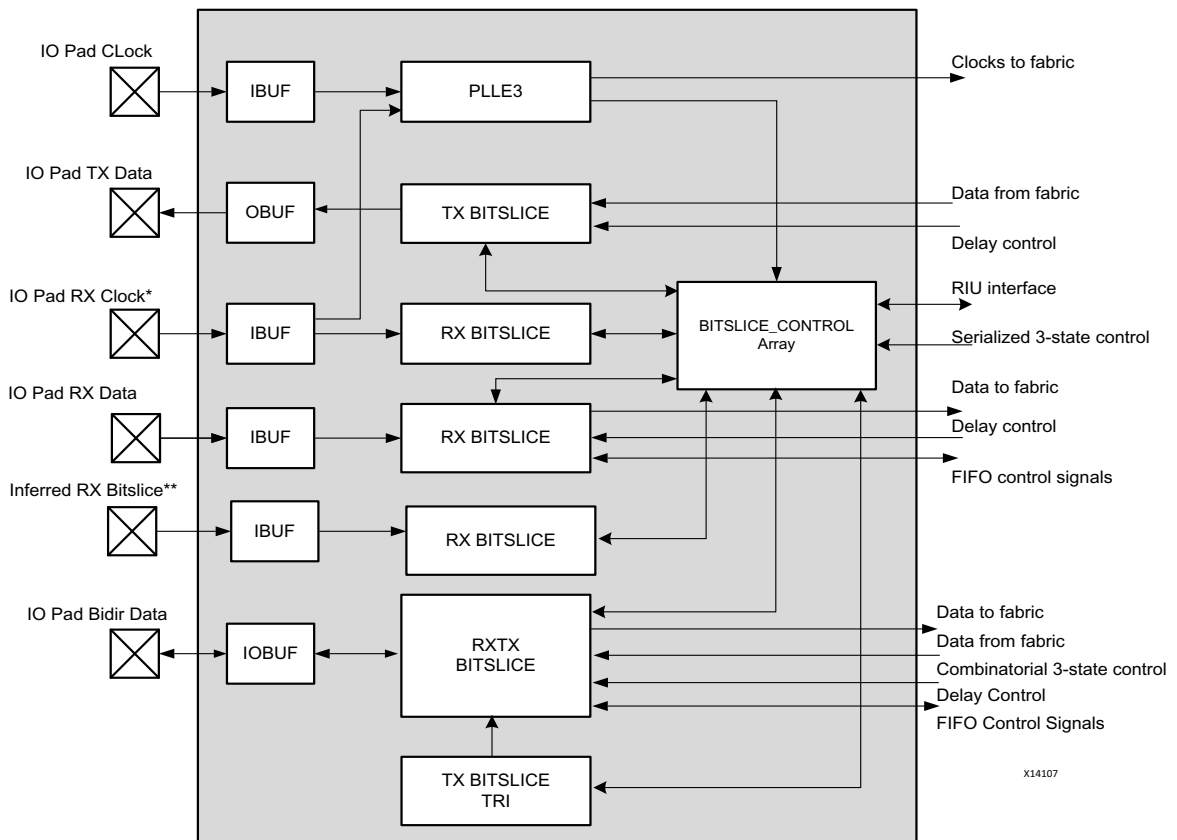

* IO RX Clock is valid only in Edge DDR/Center DDR and clock pin is on GC_QBC pin (Byte group2 pin0)
** No need to drive data on inferred RX bitslice. Wizard infers a bitslice for strobe propagation.

Figure 2-1: Representative Design

The HDL wrapper instantiates all the bitslices related to an I/O bank. Depending on the pin selected, corresponding bitslices are connected to the general interconnect and I/Os. The Wizard also provides LOC constraints to the top level ports.

Performance

The HSSIO Wizard performance is measured by the data speed that it can support, which in turn is the capability realized in the selected I/Os of the device. Refer to the *UltraScale Architecture SelectIO Resources: Advance Specification User Guide* (UG571) [Ref 1] for more details on the performance characteristics.

This core supports a maximum data speed of 1,600 Mb/s for serialization factor 8 and 1,600 Mb/s for serialization factor 4. The general interconnect logic works at 1/8 or 1/4 clock of the interface speed clock.

Resource Utilization

For full details about performance and resource utilization, visit the [Performance and Resource Utilization web page](#)

This core uses a flip-flop to generate `clkoutphyen` of the PLL for the circuit stabilization before the actual data is sent on the I/O. Other blocks used are FPGA hard blocks.

Port Descriptions

Table 2-1 and Table 2-2 describe the input and output ports of the High Speed SelectIO Wizard. Availability of ports is controlled by user selection.

Table 2-1 lists ports that are top-level ports connected to the FPGA I/O. The renaming feature is useful for multiple instances of the core in the design to avoid conflicting pin LOC constraints

Table 2-1: Ports Connected to FPGA I/O

Port	Direction	Clock Domain	Description
Global Ports			
clk_p	Input	NA	Differential clock input P connected to PLL. The port is available only when a PLL is instantiated in the core.
clk_n	Input	NA	Differential clock input N connected to PLL. The port is available only when a PLL is instantiated in the core.
clk	Input	NA	Single ended clock connected to PLL. The port is available only when a PLL is instantiated in the core.
rst	Input	riu_clk	Global reset pin. Assertion of the reset is asynchronous. Deassertion is synchronous with respect to the RIU clock when you provide a RIU clock as an input to the core. Minimum pulse width should be 5 ns. Refer to the PLL Switching Characteristics section in the <i>Kintex UltraScale Architecture Data Sheet (DS892)</i> [Ref 2].

Table 2-1: Ports Connected to FPGA I/O (Cont'd)

Port	Direction	Clock Domain	Description
bg<x>_pin<y>_<pin num>	Input/ Output/ Inout	NA	Data/Input Clock/Strobe/Clk forward ports connected to I/O pins. Port name of the wizard IP is user-specified through Vivado® Integrated Design Environment (IDE) appended with the pin number in the bank when Append Pin No. to IOs is selected. To elaborate, the wizard appends the pin_num (range from 0 - 51, number of pins in a full bank) to the port name during generation. The default port name is bg<x>_pin<y>_<pin num>. (You can overwrite the default port name from its default value.) In this naming convention, x indicates the byte group and its value ranges from 0 to 3 and y indicates the pin position within the bytegroup and its value ranges from 0-12. For example, if you select the 13th pin and the signal name is bg1_pin0, the actual port name is bg1_pin0_13 and the corresponding signal name to the interconnect end would be - data_from_fabric_bg1_pin10_13 or data_to_fabric_bg1_pin10_13 depending on the direction of the pin chosen.
bg<x>_pin<y>_nc	Input	NA	Inferred bitslice ports. The wizard infers bitslice0 of a nibble for strobe propagation within the bytegroup; <x> indicates bytegroup (0,1,2,3); <y> indicates bitslice0 position (0 in case of lower nibble, 6 in case of upper nibble.) There is no need to drive any data on these ports.

Table 2-2: Ports Connected to FPGA General Interconnect Logic

Port	Direction	Clock Domain	Description
Data Ports			
data_from_fabric_<sig_name>_<y> [sf -1:0]	Input	pll0_clkout0	Parallel data input from the interconnect logic to TX/Bidir TX bitslices. <sig_name> is the signal name configured for TX/Bidir bus direction during customization. <y> is the pin number (range from 0 -51) appended by the wizard when Append Pin No. to IOs is selected. sf is the serialization factor.
data_to_fabric_<sig_name>_<y> [sf-1:0]	Output	pll0_clkout0	Parallel data output to general interconnect logic from RX/Bidir RX bitslices. <sig_name> is the signal name configured for RX/Bidir bus direction during customization. <y> is the pin number (range from 0 to 51) appended by the wizard when Append Pin No. to IOs is selected. sf is the serialization factor. For differential RX pins, the parallel data corresponding to the N pin is also available.
Clock Ports			
pll0_clkout0	Output	NA	Divided version of clock from PLL CLKOUT0 for the general interconnect logic. The frequency of this is data speed divided by the serialization factor. This clock can be used as a clock for the general interconnect logic.
pll0_clkout1	Output	NA	Divided version of the clock from PLL CLKOUT1 for the general interconnect logic from PLL0. The frequency of this can be set in Vivado IDE from a list of supported frequencies for the data speed chosen.
pll1_clkout0	Output	NA	Divided version of the clock from PLL CLKOUT0 for the general interconnect logic from PLL1. The frequency of this can be set in Vivado IDE from a list of supported frequencies for the data speed chosen.

Table 2-2: Ports Connected to FPGA General Interconnect Logic (Cont'd)

Port	Direction	Clock Domain	Description
RX/Bidir RX Delay Control Ports			
rx_clk	Input	NA	DELAY clock used to sample LOAD, CE and INC for RX.
rx_cntvalue_in_<i> [8:0]	Input	rx_clk/bidir_rx_clk	Counter value from the FPGA logic for dynamically loadable tap value for RX. <i> is the corresponding pin number on which the RX/Bidir bus direction is selected.
rx_cntvalue_out_<i> [8:0]	Output	rx_clk/bidir_rx_clk	Counter value going to FPGA logic for monitoring the tap value for RX. <i> is the corresponding pin number on which the RX/Bidir bus direction is selected.
rx_ce_<i>	Input	rx_clk/bidir_rx_clk	Clock enable for the IDELAY register clock for RX. <i> is the corresponding pin number on which the RX/Bidir bus direction is selected.
rx_en_vtc<i>	Input	rx_clk/bidir_rx_clk	Active-High to enable DELAYCTRL to keep delay over voltage and temp to load new delay for RX Delay Control. <i> is the pin number on which the RX/Bidir bus direction is selected.
rx_inc<i>	Input	rx_clk/bidir_rx_clk	Increment the current delay tap setting for RX. <i> is the pin number on which the RX/Bidir bus direction is selected.
rx_load<i>	Input	rx_clk/bidir_rx_clk	Load the count value from CNTVALUEIN for RX. <i> is the pin number on which the RX/Bidir bus direction is selected.
RX Extended Delay Control Ports			
rx_cntvalue_in_ext_<i> [8:0]	Input	rx_clk	Extended counter value from the FPGA logic for dynamically loadable tap value for RX. <i> is the corresponding pin number on which the RX bus direction is selected.
rx_cntvalue_out_ext_<i> [8:0]	Output	rx_clk	Extended counter value going to the FPGA logic for monitoring the tap value for RX. <i> is the corresponding pin number on which the RX bus direction is selected.

Table 2-2: Ports Connected to FPGA General Interconnect Logic (Cont'd)

Port	Direction	Clock Domain	Description
rx_ce_ext_<i>	Input	rx_clk	Extended clock enable for the IDELAY register clock for RX. <i> is the corresponding pin number on which the RX bus direction is selected.
rx_en_vtc_ext_<i>	Input	rx_clk	Extended active-High to enable DELAYCTRL to keep delay over voltage and temp to load new delay for RX Delay Control. <i> is the pin number on which the RX bus direction is selected.
rx_inc_ext_<i>	Input	rx_clk	Extended increment the current delay tap setting for RX. <i> is the pin number on which the RX bus direction is selected.
rx_load_ext_<i>	Input	rx_clk	Extended load count value from CNTVALUEIN for RX. <i> is the pin number on which the RX bus direction is selected.
TX/Bidir TX Delay Control Ports			
tx_clk	Input	NA	DELAY clock used to sample LOAD, CE INC for TX.
tx_cntvalue_in_<i>[8:0]	Input	tx_clk/bidir_tx_clk	Counter value from the FPGA logic for dynamically loadable tap value for TX. <i> is the corresponding pin number on which the TX/Bidir bus direction is selected.
tx_cntvalue_out_<i>[8:0]	Output	tx_clk/bidir_tx_clk	Counter value going to the FPGA logic for monitoring the tap value for TX. <i> is the corresponding pin number on which the TX/Bidir bus direction is selected.
tx_ce_<i>	Input	tx_clk/bidir_tx_clk	Clock enable for the ODELAY register clock for TX. <i> is the corresponding pin number on which the TX/Bidir bus direction is selected.
tx_en_vtc_<i>	Input	tx_clk/bidir_tx_clk	Active-High to enable DELAYCTRL to keep delay over voltage and temp to load new delay for TX Delay Control. <i> is the pin number on which the TX/Bidir bus direction is selected.
tx_inc_<i>	Input	tx_clk/bidir_tx_clk	Increment the current delay tap setting for TX. <i> is the pin number on which the TX/Bidir bus direction is selected.

Table 2-2: Ports Connected to FPGA General Interconnect Logic (Cont'd)

Port	Direction	Clock Domain	Description
tx_load<i>	Input	tx_clk/bidir_tx_clk	Load the count value from CNTVALUEIN for TX. <i> is the pin number on which the TX/Bidir bus direction is selected.
Bidir Delay Clock Ports			
bidir_tx_clk	Input	NA	DELAY clock used to sample LOAD, CE, INC for TX
bidir_rx_clk	Input	NA	DELAY clock used to sample LOAD, CE, INC for RX
TXBITSlice_TRI Delay Control Ports			
bidir_tx_bs_tri_clk	Input	bidir_tx_clk	Delay Clock used to sample LOAD, CE, INC
bidir_tx_bs_tri_cntvaluein<n>[8:0]	Input	bidir_tx_clk	Counter value from the FPGA logic for dynamically loadable tap value, 1 per nibble, <n> indicates the nibble number that varies from 0 to 7.
bidir_tx_bs_tri_cntvalueout<n>[8:0]	Output	bidir_tx_clk	Counter value to the FPGA logic for monitoring the tap value of the delay control, 1 per nibble, <n> indicates the nibble number that varies from 0 to 7.
bidir_tx_bs_tri_ce<n>	Input	bidir_tx_clk	Clock Enable for the ODELAY register clock, 1 per nibble, <n> indicates the nibble number that varies from 0 to 7.
bidir_tx_bs_tri_en_vtc<n>	Input	bidir_tx_clk	Active-High to enable DELAYCTRL to keep delay over voltage and temp to load a new delay for TXBITSlice TRI Delay Control. <n> indicates the nibble number that varies from 0 to 7.
bidir_tx_bs_tri_inc<n>	Input	bidir_tx_clk	Increment the current delay tap setting, 1 per nibble. <n> indicates the nibble number that varies from 0 to 7.
bidir_tx_bs_tri_load<n>	Input	bidir_tx_clk	Load the count value from CNTVALUEIN, 1 per nibble. <n> indicates the nibble number that varies from 0 to 7.

Table 2-2: Ports Connected to FPGA General Interconnect Logic (Cont'd)

Port	Direction	Clock Domain	Description
3-State Ports			
tri_tbyte<n>[3:0]	Input	pll0_clkout0	Serialized 3-state input, 1 per nibble, <n> indicates the nibble number that varies from 0 to 7.
tri_t<i>	Input	pll0_clkout0	Combinatorial Data 3-State input, 1 per bitslice. <i> is the pin number on which the bidir bus is selected.
RIU Ports			
riu_addr_bg<m>[5:0]	Input	riu_clk	Address of the RIU register. <m> indicates bytegroup. Varies from 0 to 3.
riu_clk	Input	NA	System clock from the general interconnect. <m> indicates bytegroup. Varies from 0 to 3. You can choose to generate the riu_clk from the PLL through a Vivado IDE selection. PLL_CLKOUT1 is used as the source for riu_clk. The presence of riu_clk is mandatory for the design.
riu_nibble_sel_bg<m>[1:0]	Input	riu_clk	Nibble select to enable RIU read/write for upper (Logic 1 or lower nibble 0). <m> indicates bytegroup. Varies from 0 to 3.
riu_wr_data_bg<m>[15:0]	Input	riu_clk	Input write data to the register. <m> indicates bytegroup. Varies from 0 to 3.
riu_wr_en_bg<m>	Input	riu_clk	Register write enable active-High. <m> indicates bytegroup. Varies from 0 to 3.
riu_rd_data_bg<m>[15:0]	Output	riu_clk	Output read data to the controller. <m> indicates bytegroup. Varies from 0 to 3.
riu_valid_bg<m>	Output	riu_clk	Output read valid to the controller. <m> indicates bytegroup. Varies from 0 to 3.
Status/Control			
pll0_locked	Output	NA	Logic High indicates PLL is locked to the desired clock frequency.
dly_rdy_bsc<n>	Output	riu_clk	Indicates fixed delay calibration completion.
vtc_rdy_bsc<n>	Output	riu_clk	PHY calibration is complete (VTC is ready – after EN_VTC is enabled). Note: VTC is Voltage and Temperature Control.

Table 2-2: Ports Connected to FPGA General Interconnect Logic (Cont'd)

Port	Direction	Clock Domain	Description
en_vtc_bsc<n>	Input	riu_clk	Active-High to enable DELAYCTRL to keep delay over voltage and temp low to load new delay.
fifo_empty_<i>	Output	pll0_clkout0	FIFO empty flag from each bitslice. <i> is the pin number on which the RX/Bidir RX is selected.
fifo_rd_en_<i>	Input	pll0_clkout0	FIFO read enable for each bit slice. <i> is the pin number on which the RX/Bidir RX is selected. This port is available only when the FIFO RD EN user control option is enabled in Vivado IDE.
fifo_rd_clk_<i>	Input	pll0_clkout0	FIFO read clock for each bitslice. <i> is the pin number on which the RX/Bidir RX is selected.
fifo_rd_data_valid	Output	fifo_rd_clk	Validated the data_to_fabric bus. This port is available only when FIFO Read Enable user control is disabled in Vivado IDE.
start_bitslip	Input	Not applicable	Reset for the bitslip logic. Active-Low. When the top level rst pin is asserted, start_bitslip should be driven Low. The start_bitslip port should be deasserted only when the Transmit partner of the serial line is transmitting the bitslip training pattern.
bitslip_error_<i>	Output	fifo_rd_clk_<i>	Error output for bitslip, When eight bitslips are performed for 8-bit serialization or four bitslips are performed for 4-bit serialization, this output is pulsed High.
rxtx_bitslip_sync_done	Output	fifo_rd_clk	Indicates that the bitslip training pattern is received at all bidirectional pins in the design.
rx_bitslip_sync_done	Output	fifo_rd_clk	Indicates that the bitslip training pattern is received at all RX pins in the design.
fifo_wr_clk_<n>	Output	NA	FIFO write clock from the bitslice0 of each nibble on which the strobe is available. This pin is available only if PLLO_FIFO_WRITE_CLK_OUT is chosen in Vivado IDE.

Table 2-2: Ports Connected to FPGA General Interconnect Logic (Cont'd)

Port	Direction	Clock Domain	Description
rst_seq_done	Output	riu_clk	Indicates that the reset sequence is completed and the wizard is ready. When this signal is asserted High, transactions can be initiated from the general interconnect logic.
shared_pll0_clkout0_in	Input	Not applicable	This port is available when you choose to instantiate the PLL in the example design. The pll0_clkout0 signal from the master core is given as an input to slave core.
shared_pll1_clkout0_in	Input	Not applicable	This port is available when you choose to instantiate the PLL in the example design. The pll1_clkout0 signal from the master core is given as an input to the slave core.
shared_pll0_clkoutphy_in	Input	Not applicable	This port is available when you choose to instantiate the PLL in the example design. The pll0_clkoutphy signal from the master core is given as an input to the slave core.
shared_pll1_clkoutphy_in	Input	Not applicable	This port is available when you choose to instantiate the PLL in the example design. The pll1_clkoutphy signal from the master core is given as an input to the slave core.
shared_pll0_locked_in	Input	Not applicable	This port is available when you choose to instantiate the PLL in the example design. The pll0_locked signal from the master core is given as an input to the slave core.
shared_pll1_locked_in	Input	Not applicable	This port is available when you choose to instantiate the PLL in the example design. The pll1_locked signal from the master core is given as an input to the slave core.
shared_pll0_clkoutphy_out	Output	Not applicable	This port is available when you choose to instantiate the PLL in the core. The pll0_clkoutphy signal from the master core is given as an output to the slave core.
shared_pll1_clkoutphy_out	Output	Not applicable	This port is available when you choose to instantiate the PLL in the core. The pll1_clkoutphy signal from the master core is given as an output to the slave core.

Designing with the Core

This chapter includes guidelines and additional information to facilitate designing with the core.

General Design Guidelines

This core is for high-speed UltraScale™ architecture designs and can be configured for a data speed range of 300-1,600 Mb/s. The following steps are recommended for all designs using the High Speed SelectIO™ Wizard.

You are expected to have the interface requirements of your application prior to generating the High Speed SelectIO (HSSIO) wizard specific to your designs — details such as interface speed, clock to data relationship, and system clocking structure. For example, what should be the source of the PLL input clock; board pin layout constraints are expected to be specified while generating with the wizard.

There can be two approaches that you can follow when it comes to pin planning. If there are no board layout restrictions, you can do the pin planning through the wizard, generate the wizard, and make sure the Vivado® design tools perform synthesis and implementation without any DRCs. You can also try to retrofit the board pin layout into the wizard pin planning. It is important to make sure the Vivado design tools complete the synthesis and implementation without any design rule checks (DRCs). In either approach, you must ensure that Vivado synthesis and implementation goes through without DRCs to avoid issues at the later stage of board design.

Clocking

The PLLs associated with each bank are the primary source for clocking the SelectIO resources in the bank. You can select the source of the input reference clock to PLL. The source can be a clock from the global clock pin (GC) or from the general interconnect through BUFG. You can also select the input clock frequency from Vivado IDE, which lists all the supported clocks for a given device.

PLL Instantiation

You are given the option in Vivado IDE to instantiate the PLL in the core or the example design. This provides ease of use to share the PLL across multiple designs in a single bank. The core that has the PLL instantiated inside it is called the *master*. Other instances of the Wizard that do not have the PLL instance inside the core are called *slaves*. The interface between the master and slave cores is shown in Figure 3-1. Note that when generating the master and slave cores, the interface speed and other PLL parameters should remain the same.

Both, PLL0 and PLL1 are instantiated in the `clk_scheme.v` module. Based on the selection, `clk_scheme.v` is instantiated in the core or example design.

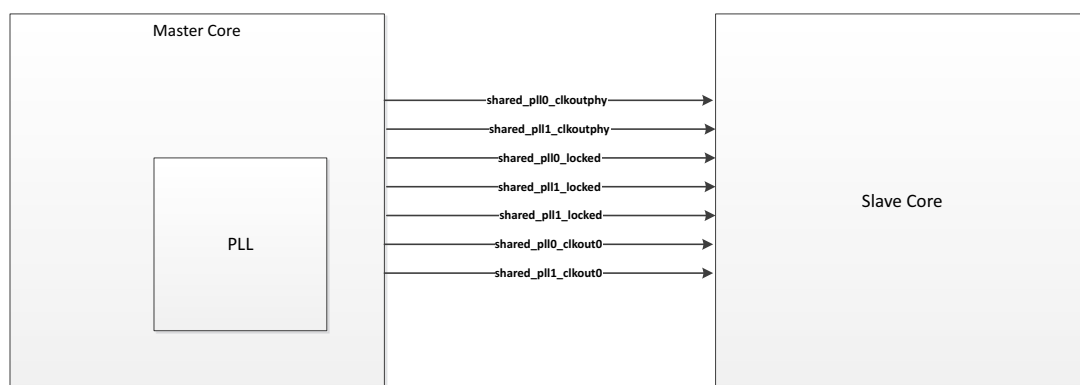

Figure 3-1: PLL Sharing

Note: For RX only designs, the option to instantiate the PLL in the example design is available only for the Edge double data rate (DDR) Strobe and Center DDR Strobe modes.

RIU Clock

An RIU Clock is mandatory for a design. The reset state machine and Bitslice control modules operate on the RIU clock. It can be provided through the `riu_clk` input port or generated internally from PLL0. You can choose the **Generate RIU clock from PLL** option in the Vivado IDE. Selecting this, enables the `PLL_CLKOUT1` signal to be used as the RIU clock internally.

Clocking of TX_BITSLICE

When transmitting data, the master input clock to the `BITSLICE_CONTROL` is used. The frequency of this clock determines the serial bit rate of data. Data is transmitted on the serial lines along with the associated clock or strobe. TX uses PLL0 by default unless RX operates in Serial Mode, when TX uses PLL1.

The clock forwarding option in the Wizard can be enabled on any pin in a given bank. The Wizard supports any number of pins as Clock Forward pins. It is mandatory that the number of clock forward pins are less than or equal to the number of Tx pins in the design. The phase of the forwarded clock with respect to the data can be set in Vivado IDE.

The Clock Forward pin acts as a Strobe/Clock for RX. The clock/strobe can be edge-aligned or center-aligned with the data. Clock/Strobe is generated similar to the data by applying a 01010101 pattern at the D[7:0] input of TX_BITSLICE / RXTX_BITSLICE. The alignment of the strobe to the data is achieved by setting the TX_OUTPUT_PHASE_90 attribute of the TX_BITSLICE/RXTX_BITSLICE.

Clocking of RX_BITSLICE

PLL0 is the primary clock source for RX. There are two modes used to capture data in the RX_BITSLICES initiated by an attribute of the BITSLICE_CONTROL component (SERIAL_MODE = TRUE/FALSE).

- When the attribute SERIAL_MODE is set to TRUE, the received data is captured using CLKOUTPHY from PLL0. This corresponds to the **ASYNC/NONE/FRACTIONAL (Beta)** option shown in Vivado IDE for the RX External Clock to Data Alignment. The receive data capture clock and receive data are either asynchronous, synchronous phase unknown, or non single data rate (SDR) or double data rate (DDR) forwarded clock associated with data. These types of applications require specialized extra logic designs to handle data recovery. For more information see [AR 64216](#). The frequency of CLKOUTPHY is half of the interface speed. In accordance with the clocking rules given in the *UltraScale Architecture SelectIO Resources: Advance Specification User Guide* (UG571) [Ref 1], the Wizard infers a RX_BITSLICE in the 0th position of a nibble related to the Rx data pin.

Note: If the input clock source to PLL is from a GC pin, then the PLL sharing option is disabled. Because the "master" core will have the PLL driven by GC. Choose the input clock source as **BUFG to PLL** for the "slave" core. When RX operates in Serial Mode, the TX and RX bitslices cannot be combined in the same nibble.

- When the attribute SERIAL_MODE is set to FALSE, the received data is captured using a clock or strobe that is forwarded with the data. This corresponds to the Edge DDR/ Center DDR/Edge DDR Strobe/ Center DDR Strobe options shown in Vivado IDE for the RX External Clock to Data Alignment.

Edge DDR

In this mode, the clock and strobe are the same. This means you have a DDR clock in the system, which can be used for data capture. The clock should be given as an input only on the GC/QBC pin (Bytegroup2 pin0). In Edge DDR and Center DDR modes, the clock acts as a Strobe, which means it should be able to propagate to all bitslices; hence it has to be present on the GC+QBC pin which is Pin 26. It is also the input reference clock to PLL; hence it is mandatory for the clock to be free-running and continuous. This clock is forwarded to all the RX data pins using the Inter Byte and Inter Nibble clocking rules as mentioned in the *UltraScale Architecture SelectIO Resources: Advance Specification User Guide* (UG571) [Ref 1]. In accordance with the rules, the Wizard infers a RX_BITSLICE in the GC/QBC pin location (Bytegroup2 pin0). The input clock is connected to the input of RX_BITSLICE. The following figure shows the alignment of clock to data.

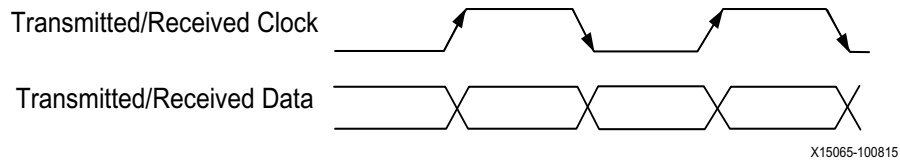

Figure 3-2: EDGE DDR

Center DDR

This is the same as in Figure 3-2 except the alignment of Clock to Data is shifted by 90 degrees. The following figure shows the alignment of clock to data.

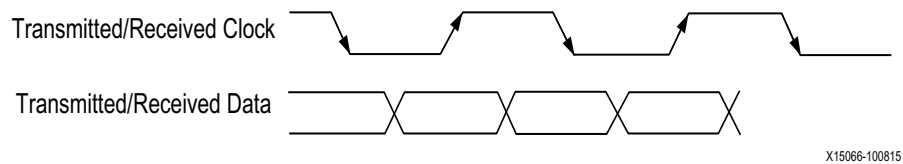

Figure 3-3: Center DDR

Edge DDR Strobe

In this mode, the RX data is captured using the incoming strobe. The strobe input can be present on any of the QBC pins present in a bank. The Wizard supports up to 8 strobes in a given bank. The propagation of strobes to RX data pins follows the Inter byte and Inter nibble clocking rules given in the *UltraScale Architecture SelectIO Resources: Advance Specification User Guide* (UG571) [Ref 1]. In accordance with the rules, the Wizard infers a RX_BITSLICE in the 0th position of every nibble where the strobe is to be propagated. The I/Os associated with the inferred bitslices are brought to the top-level wrapper with the "_nc" suffix. It is mandatory to constrain these I/Os in the XDC file for correct functioning of the design.

The strobe pin nearest to an RX data pin is chosen as the associated strobe for the data pin. Special care needs to be taken while pin planning to ensure that the appropriate strobe and data pin positions are chosen.

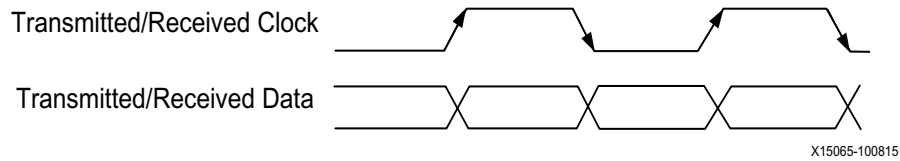

Figure 3-4: Edge DDR Strobe

Center DDR Strobe

This is the same as in [Edge DDR Strobe](#) except that the strobe to data alignment is shown in [Figure 3-5](#).

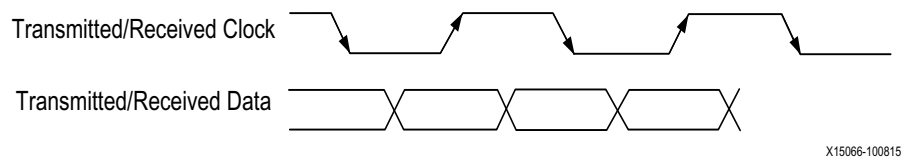

Figure 3-5: Center DDR Strobe

Advanced Strobe/Clock Mode

Advanced Strobe/Clock Mode is used to sample a single data line using two independent strobes. This option is available only in Edge DDR Strobe/Clock and Center DDR Strobe/Clock mode. The timing relation between the data and the strobe is shown below.

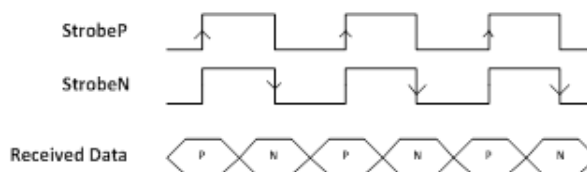

Figure 3-6: Advanced Strobe

- The P data is sampled on the rising edge of StrobeP.
- The N data is sampled on the falling edge of StrobeN.
- StrobeP and StrobeN are given to individual nibbles in the same bytegroup.
- Attribute EN_OTHER_PCLK is set for the nibble that has StrobeN/InvStrobeN as input.
- Attribute EN_OTHER_NCLK is set for the nibble that has StrobeP/InvStrobeP as input.

If a nibble has StrobeP as input, possible strobe/clock selection of the other nibble are: StrobeN or InvStrobeN (invert of StrobeN)

If a nibble has StrobeN as input, possible strobe/clock selection of the other nibble are: StrobeP or InvStrobeP (invert of StrobeP).

Clocking of RXTX_BITSLICE

The TX part of RXTX_BITSLICE follows the same clocking as given in [Clocking of TX_BITSLICE](#).

The RX part of RXTX_BITSLICE supports only EDGE DDR Strobe or Center DDR Strobe mode. This means that the presence of a strobe is mandatory for data capture in RXTX_BITSLICE.

Usage of PLLs

If the design contains a mix of TX, RX and RX_TX bitslices, the usage of PLLs is shown in [Table 3-1](#). When RX operates in Serial Mode, TX and RX bitslices cannot be combined in the same nibble. When RX operates in Serial Mode, Bidirectional (RXTX) operation is not supported.

Table 3-1: Usage of PLLs

Design Configuration	External Clock to Data Alignment	PLL Usage	Description
TX + RX	Edge DDR, Center DDR, Edge DDR Strobe, Center DDR Strobe	TX uses PLL0	The master input clock to all BITSlice_CONTROL modules is from PLL0.
		RX uses PLL0	
TX + RX	ASYNC/NONE/FRACTIONAL (Beta)	TX uses PLL1	The master input clock to BITSlice_CONTROL associated with TX is from PLL1.
		RX uses PLL0	The master input clock to BITSlice_CONTROL associated with RX is from PLL0.
TX + RX + RXTX	Edge DDR Strobe, Center DDR Strobe	TX uses PLL0	The master input clock to all BITSlice_CONTROL modules is from PLL0.
		RX uses PLL0	
		RXTX uses PLL0	

Resets

The Wizard generates a reset module that is built in the wrapper. This module runs on the RIU clock. The input is an asynchronous reset that triggers resets to all Bitslice and Bitslice Control modules in the design. The following diagram gives the details of the reset state machine with an external RIU clock input.

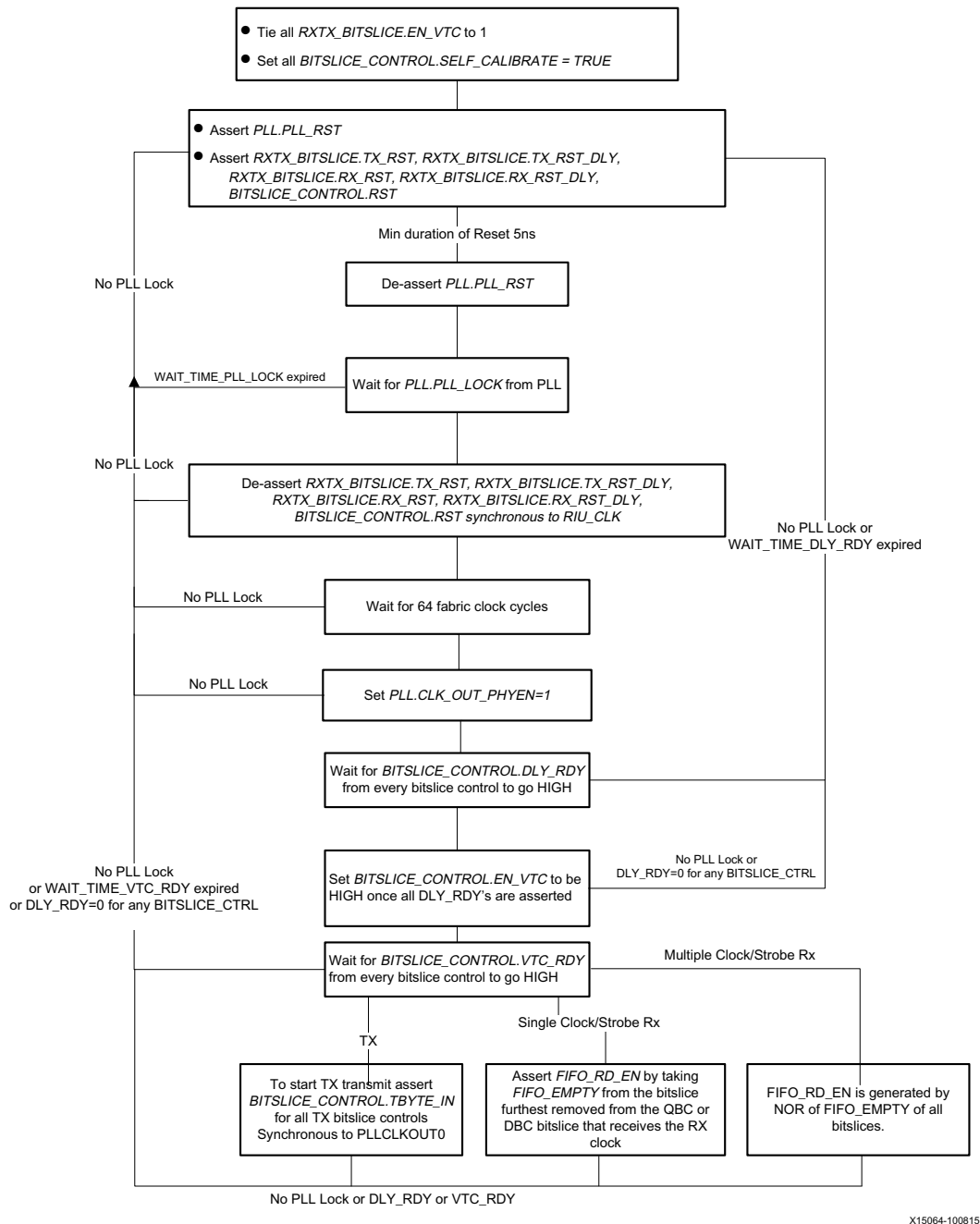

Figure 3-7: HSSIO Reset Sequence

The reset logic when RIU clock is generated from PLL is given below.

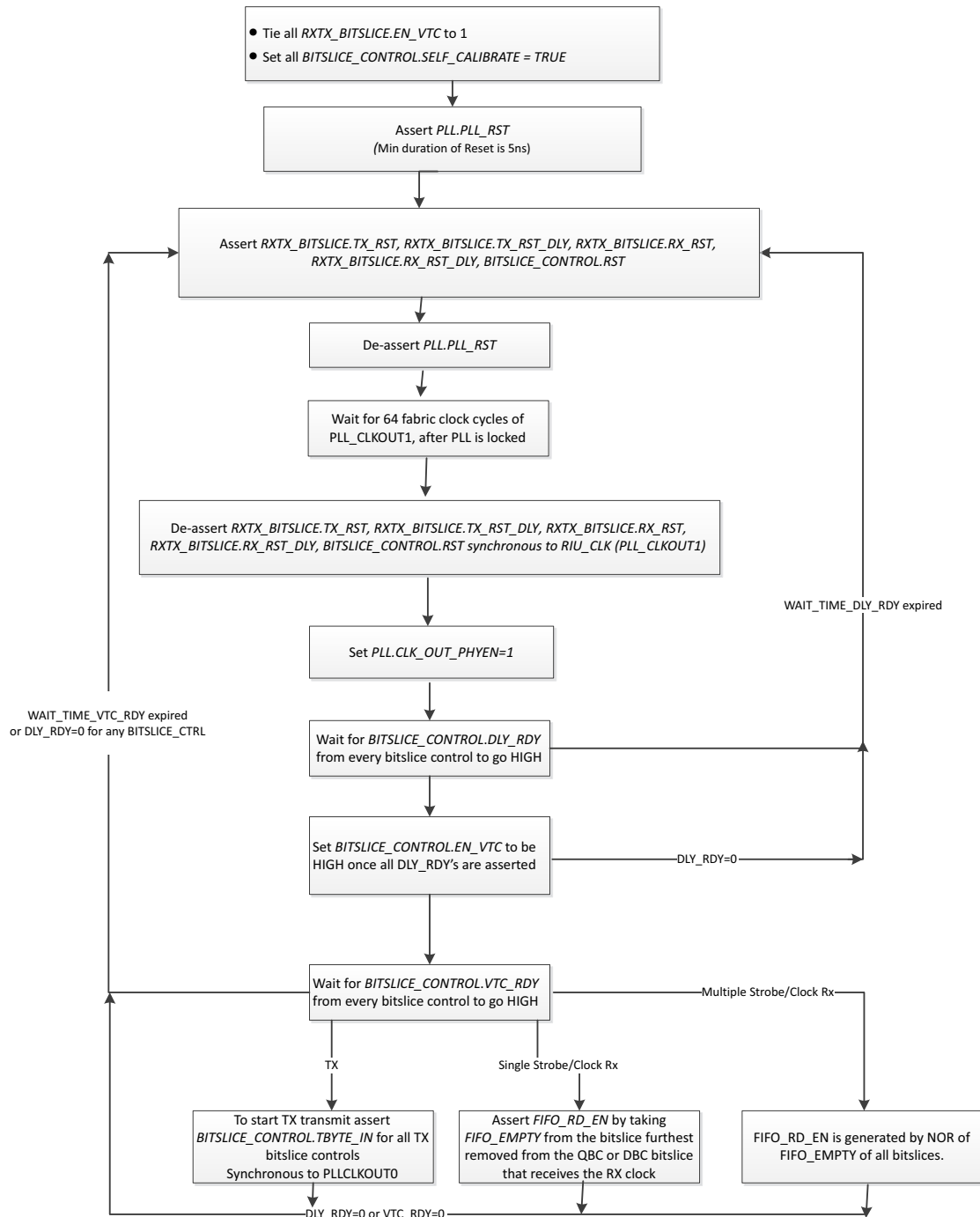

Figure 3-8: RIU From PLL

When any pin is enabled as Clock Forward, it is mandatory to hold the counterpart design (RX) in reset until the TX is out of reset and `rst_seq_done` of TX is asserted. This will ensure a reliable clock to the RX.

Note: All wait times shown in [Figure 3-7](#) are hard coded to 1 million RIU clock cycles.

Protocol Description

The SelectIO resources can be used to interface many different serial protocols operating in the 300 Mb/s to 1,600 Mb/s range based on the device and speed grade selected. For more details, refer to the following documents.

- *UltraScale Architecture SelectIO Resources: Advance Specification User Guide* (UG571) [\[Ref 1\]](#)
- *Kintex UltraScale Architecture Data Sheet* (DS892) [\[Ref 2\]](#)
- *Virtex UltraScale FPGAs Data Sheet* (DS893) [\[Ref 3\]](#)
- *Kintex UltraScale+ FPGAs Data Sheet* (DS922) [\[Ref 4\]](#)

Design Flow Steps

This chapter describes customizing and generating the core, constraining the core, and the simulation, synthesis and implementation steps that are specific to this IP core. More detailed information about the standard Vivado® design flows and the IP integrator can be found in the following Vivado Design Suite user guides:

- *Vivado Design Suite User Guide: Designing IP Subsystems using IP Integrator* (UG994) [Ref 5]
- *Vivado Design Suite User Guide: Designing with IP* (UG896) [Ref 6]
- *Vivado Design Suite User Guide: Getting Started* (UG910) [Ref 7]
- *Vivado Design Suite User Guide: Logic Simulation* (UG900) [Ref 8]

Customizing and Generating the Core

This section includes information about using Xilinx tools to customize and generate the core in the Vivado Design Suite. You can customize the IP for use in your design by specifying values for the various parameters associated with the IP core using the following steps:

1. Select the IP from the IP catalog.
2. Double-click the selected IP or select the Customize IP command from the toolbar or right-click menu.

For details about starting a Vivado project, see the *Vivado Design Suite User Guide: Designing with IP* (UG896) [Ref 6] and the *Vivado Design Suite User Guide: Getting Started* (UG910) [Ref 7].

For details about output generation, see the *Vivado Design Suite User Guide: Designing with IP* (UG896) [Ref 6].

Note: Figures in this chapter are illustrations of the Vivado IDE. The layout depicted here might vary from the current version.

General Vivado IDE Settings

Component Name: Component name is user defined. Component names must not contain any reserved words in Verilog.

Configuration Settings

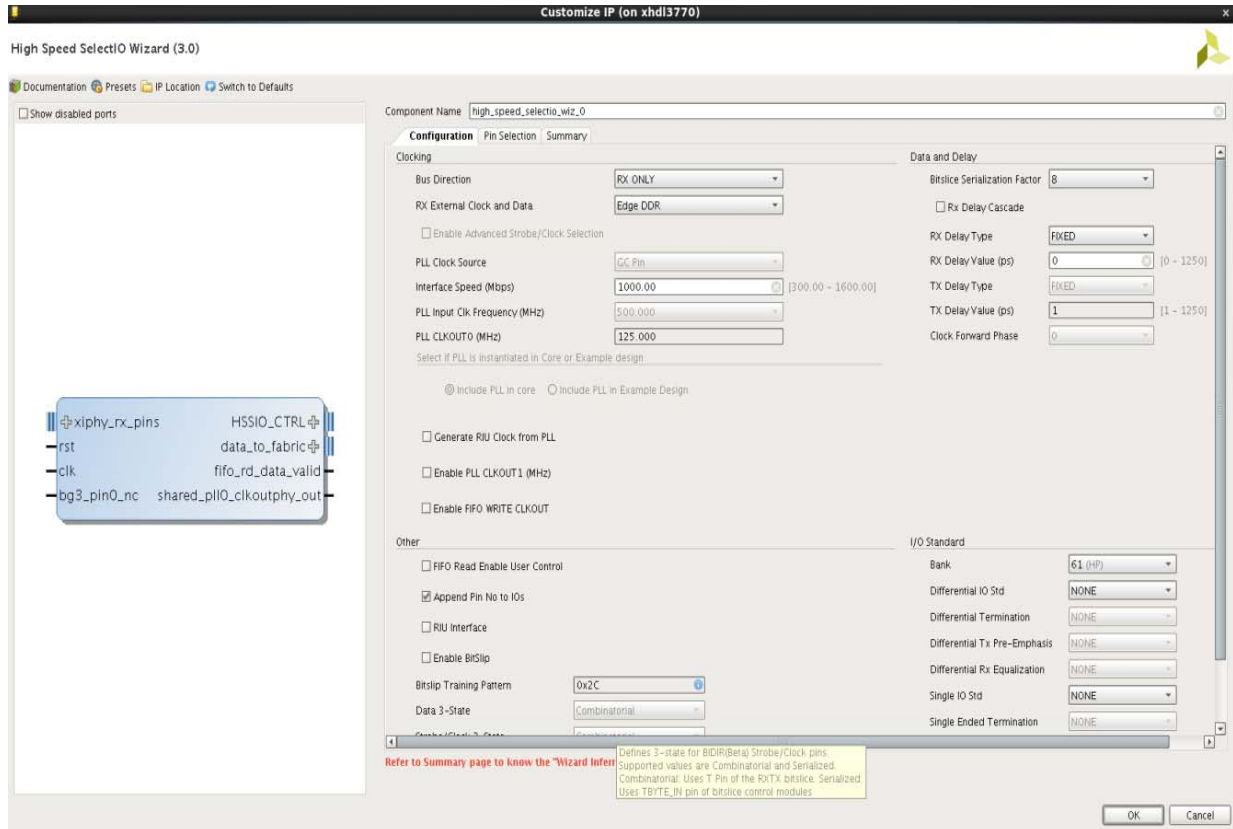

Figure 4-1: Configuration Settings for the Interface

Clocking

Bus Direction

Indicates the direction of the pins in the user design.

- **TX ONLY:** Indicates that the user design contains only TX pins.
- **RX ONLY:** Indicates that the user design contains only RX pins.
- **BIDIR or TX+RX or TX+RX+BIDIR:** Indicates that the user design contains a mix of TX, RX and BiDir (Beta) pins.

Note: The Bidirectional signaling feature is available; however, there may be a modification noted depending on the application. See [AR 64216](#) for additional details

RX External Clock and Data Alignment

Indicates the alignment of external clock to data. This is applicable for RX and BiDir (Beta) pins.

- **Edge DDR:** Applicable only when Bus Direction is set to RX Only. Refer to [Clocking in Chapter 3](#) for detailed information.
- **Center DDR:** Applicable only when Bus Direction is set to RX Only. Refer to [Clocking in Chapter 3](#) for detailed information.
- **ASYNC/NONE/FRACTIONAL (Beta):** Refer to [Clocking in Chapter 3](#) for detailed information.
- **Edge DDR Strobe/Clock:** Applicable to RX and BiDir (Beta) pins. Refer to [Clocking in Chapter 3](#) for detailed information.
- **Center DDR Strobe/Clock:** Applicable to RX and BiDir (Beta) pins. Refer to [Clocking in Chapter 3](#) for detailed information.
- **Enable Advanced Strobe Selection:** See [Clocking in Chapter 3](#) for detailed information.

PLL Clock Source

The clock is sent to the PLL through the buffer set in this option.

- **GC Pin:** Choose this option if the input clock is available on the GC pin. In this case the input clock goes to PLL via IBUF (for single-ended clock) or IBUFDS (for differential clock) instantiated by the wizard.
- **Fabric (Driven by BUFG):** Choose this option if the clock is sent from the general interconnect. The Wizard connects the input clock port (clk) directly to the PLL. You need to ensure that a BUFG is instantiated in the interconnect.

Interface Speed (Mbps)

Sets the interface speed for the configuration. The interface speed is defined by the device and speed grade selected. Refer to the Ultrascale™ and Ultrascale+ data sheets for more info.

PLL Input Clk Frequency (MHz)

Sets the input clock frequency for the PLL. Depending on the data speed selected, a range of supported input clock frequencies are listed. For EDGE DDR/CENTER DDR, the input clock frequency is set to half of the data speed.

PLL CLKOUT0 (MHz)

Displays the frequency of the CLKOUT0 of PLL0 (Divided clock from PLL0). The frequency of this clock is Data speed/Serialization factor.

Select if PLL is included in Core or Example design

See [Clocking in Chapter 3](#) for detailed information.

Generate RIU Clock from PLL

See [Clocking in Chapter 3](#) for detailed information.

ENABLE PLL CLKOUT1 MHz

Setting this enables the CLKOUT1 port of PLL0 to be brought as the output port of the wrapper.

Note: If two PLLs are being used by the design, CLKOUT1 of PLL1 is not available as an output port. Only CLKOUT1 of PLL0 is available if Enable PLL CLKOUT1 is enabled.

Enable FIFO WRITE CLKOUT

Enables the internal FIFO divided write clock output to the interconnect logic. This clock is from bitslice 0 of each nibble on which the Strobe/Clock is available. Refer to the *UltraScale Architecture SelectIO Resources: Advance Specification User Guide* (UG571) [\[Ref 1\]](#) for more information.

Data and Delay Settings**BITSLICE Serialization Factor**

Defines the serialization factor for parallel data input/output width from/to the general interconnect. Legal values are 4 and 8. The serialization factor is set to 8 by default.

RX Delay Cascade

Enables cascading of IDELAY and extended delay lines to get a total of 2.5 ns delay on the RX datapath. RX delay cascade is not supported for BiDir (Beta) pins.

RX Delay Type

- **FIXED:** Fixed delay value set through **RX Delay Value** is applied on RX data.
- **VARIABLE:** Delay on RX data can be incremented or decremented from the default value using delay control inputs CE, CLK, and INC.
- **VAR_LOAD:** Delay on RX data can be incremented or decremented from the default set value or loaded with a new value on CNTVALUEIN using delay control inputs CE, CLK, and INC.

RX Delay Value (ps)

Value of the desired RX delay in picoseconds. Maximum value is 1,250 ps when RX Delay Cascade is FALSE. If RX Delay Cascade is enabled, this delay can be configured to 1,250 or 2,500 ps.

Note: For bidirectional PINS RX and TX delay types should be the same. For bidirectional pins, the Wizard sets the Rx Delay Value to 0

TX Delay Type

- **FIXED:** Fixed delay value set through **TX Delay Value** is applied on TX data.
- **VARIABLE:** Delay on TX data can be incremented or decremented from the default value using delay control inputs CE, CLK, and INC.
- **VAR_LOAD:** Delay on TX Data can be incremented or decremented from the default set value or loaded with a new value on CNTVALUEIN using delay control inputs CE, CLK, and INC.

TX Delay Value (ps)

Value of desired TX delay in picoseconds. The logic to allow conversion of the delay value (in ps) to a certain number of taps is built into the I/O control logic. This logic requires a reference clock. No tap dependent jitter is added by the delay line.

Note: For bidirectional buses, RX/TX delay type should be the same. For bidirectional pins, the Wizard sets the Tx Delay Value to 0.

Clock Forward Phase

Available only for the TX pins. Sets the phase between clock forward and TX data. Supported values are 0 and 90.

Other Settings

FIFO Read Enable User Control

FIFOs in RX/RXTX Bitslices allow transferring data from the source synchronous interface clock domain to the fabric clock domain. For single clock source synchronous interfaces, the fabric side drives FIFO_RD_EN by taking FIFO_EMPTY from the bitslice farthest from the Quad Byte Clock (QBC) or Dedicated Byte Clock (DBC) bitslice that receives the Strobe/Clock.

For multi-clock source synchronous interfaces, the FIFO_RD_EN is connected to the NOR of FIFO_EMPTY of all bitslices in the interface.

When you enable this check box, the FIFO_RD_EN ports are brought to the top-level wrapper and you are expected to drive the port as per the scenarios mentioned above.

By default, the Wizard drives the FIFO_RD_EN ports internally. The output port `fifo_rd_data_valid` can be used to determine the presence of valid data on the `data_to_fabric` bus.

Refer to the following timing diagrams. When Bitslip is enabled, the latency through the bitslip logic is four FIFO_RD_CLK cycles.

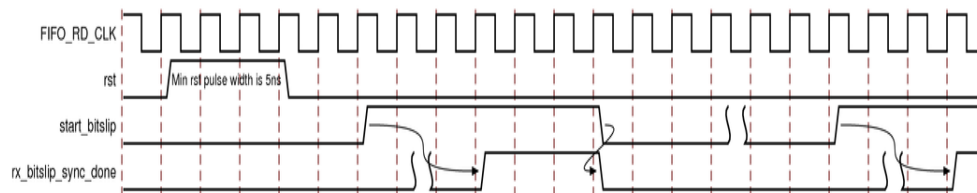

Figure 4-2: Bitslip Disabled and FIFO Read Enable User Controlled

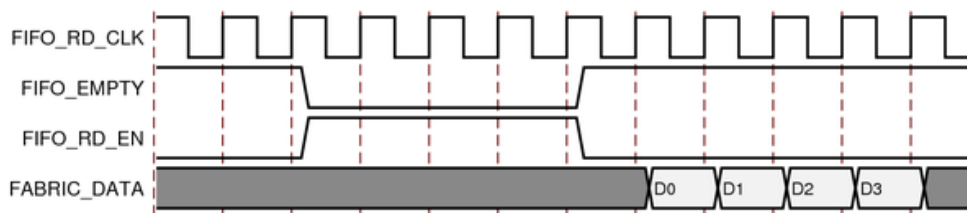

Figure 4-3: Bitslip Enabled and FIFO Read Enable User Controlled

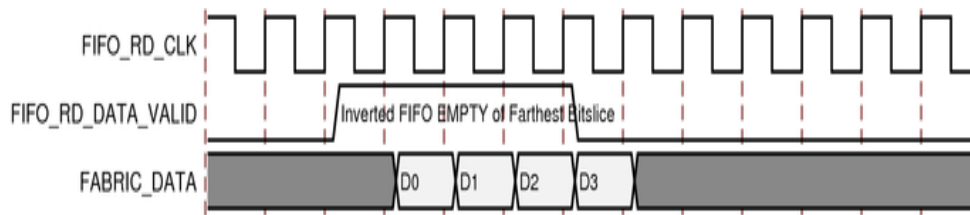

Figure 4-4: Bitslip Disabled and FIFO Read Enable Controlled by Wizard

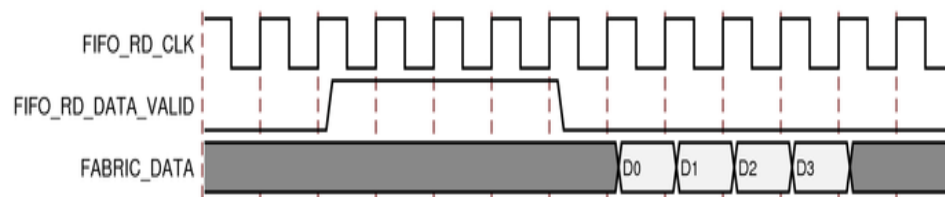

Figure 4-5: Bitslip Enabled and FIFO Read Enable Controlled by Wizard

Append Pin No. to IOs

When selected, the user-defined signal names are suffixed with the corresponding pin number in the bank.

RIU Interface

Enables Register Interface Unit (RIU) for each bytgroup to access internal registers. Every delay element tap setting can be read with the RIU. Various features, such as clock gating and Voltage Temperature (VT) tracking, can be disabled. With this option, you can dynamically change the FIFO usage (for example, from synchronous to asynchronous to full bypass). It enables the Register Interface Unit (RIU) access, but does not add additional logic for RIU access.

Enable Bitslip

For bus direction RX, BiDir (Beta) RX, bitslip logic can be enabled to align the RX data with the expected pattern.

Bitslip Training Pattern

For Bitslip logic to achieve sync, a pre-defined training pattern (in HEX format) should be received. The training pattern should be unique and defined by the higher level protocol. The `start_bitslip` port (active-Low) holds the bitslip logic in reset. The `start_bitslip` port should be driven High only when the transmitter has started driving the valid bitslip training pattern. The transmitter is expected to send the training pattern continuously until the `rx_bitslip_sync_done` (for Rx Interfaces) or `rxtx_bitslip_sync_done` (for BiDir (Beta) interfaces) signals are asserted.

Refer to the following timing diagram for more details.

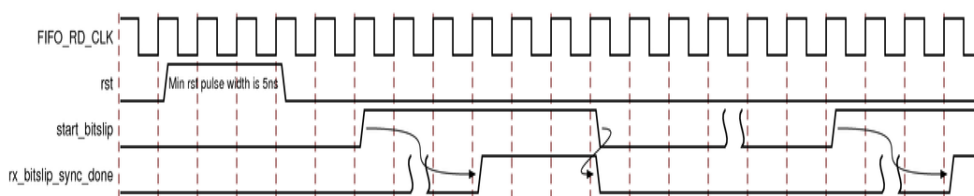

Figure 4-6: Bitslip Training Pattern Diagram

Data 3-State

Sets the 3-state control for the bidirectional Data pins. Strobes/Clocks are valid only in receive mode.

- **Combinatorial:** Uses the T pin of the RXTX_BITSLICE. The T input from the general interconnect logic directly goes to RXTX_BITSLICE.
- **Serialized:** The TBYTE_IN input coming from general interconnect logic goes to the BITSLICE_CONTROL and controls the TBYTE_IN of RXTX_BITSLICE through TX_BITSLICE_TRI. Refer to the *UltraScale Architecture SelectIO Resources: Advance Specification User Guide* (UG571) [Ref 1] on how to use TBYTE_IN.

Strobe/Clock

Sets the 3-state control for the Strobe/Clock pins. The DBC/QBC pins can be set as Strobe/Clock pins and are valid only for receive mode. Refer to the *UltraScale Architecture SelectIO Resources: Advance Specification User Guide* (UG571) [Ref 1] for information on strobes.

- **Combinatorial:** Uses the T pin of the RXTX_BITSLICE. The T input from the general interconnect logic directly goes to RXTX_BITSLICE. Each data bitslice has one strobe pin. When Strobe/Clock is available, RX data is captured with respect to the strobe.
- **Serialized:** The TBYTE_IN input coming from general interconnect logic goes to the BITSLICE_CONTROL and controls the TBYTE_IN of RXTX_BITSLICE through TX_BITSLICE_TRI. Refer to the *UltraScale Architecture SelectIO Resources: Advance Specification User Guide* (UG571) [Ref 1] for information on TBYTE_IN.

I/O Standard Settings

Bank

Lists all available High Performance (HP) and High Range (HR) banks for the selected device.

Differential IO Standard

Differential IO standards supported by the selected Bank are shown here. If the your design contains Differential Pins, it is mandatory to set the Differential IO standard.

Differential Termination

Selection of the ODT (On Die Termination) value for the Differential I/O Standard. The user selected value is set in the XDC constraints file. Refer to the *UltraScale Architecture SelectIO Resources: Advance Specification User Guide* (UG571) [\[Ref 1\]](#) for more details.

Differential Tx Pre-Emphasis

Selection of the Transmitter Pre-Emphasis setting for Differential I/O Standard. The Pre-Emphasis value is set in the XDC constraints file. Refer to the *UltraScale Architecture SelectIO Resources: Advance Specification User Guide* (UG571) [\[Ref 1\]](#) for more details.

Differential Rx Equalization

Selection of the Rx equalization setting for Differential IO Standard. The Equalization value is set in the XDC constraints file. Refer to the *UltraScale Architecture SelectIO Resources: Advance Specification User Guide* (UG571) [\[Ref 1\]](#) for more details.

Single IO Standard

Single Ended IO standards supported by the selected Bank and compatible with the Differential IO standard are shown here. If your design contains Single Ended Pins, it is mandatory to set the Single Ended IO standard. For RX only designs, you might not see the complete list of Single Ended IO standards compatible with the selected Differential IO Standard.

Single Ended Termination

Selection of the ODT (On Die Termination) value for the Single Ended IO Standard. The user selected value is set in the XDC constraints file. Refer to the *UltraScale Architecture SelectIO Resources: Advance Specification User Guide* (UG571) [\[Ref 1\]](#) for more details.

Single Ended Tx Pre-Emphasis

Selection of the Transmitter Pre-Emphasis setting for Single Ended IO Standard. The Pre-Emphasis value is set in the XDC constraints file. Refer to the *UltraScale Architecture SelectIO Resources: Advance Specification User Guide* (UG571) [\[Ref 1\]](#) for more details.

Single Ended Rx Equalization

Selection of Rx equalization setting for Single Ended IO Standard. The Equalization value is set in the XDC constraints file. Refer to the *UltraScale Architecture SelectIO Resources: Advance Specification User Guide (UG571)* [Ref 1] for more details.

Pin Selection Tab

This tab provides the option to select the pins and for each selected pin allows you to set the pin direction [TX, RX, BiDir (Beta)], signal type (Differential/Single ended), signal name, and also select a pin as Data, Strobe/Clock, Input Clock or Clock Forward.

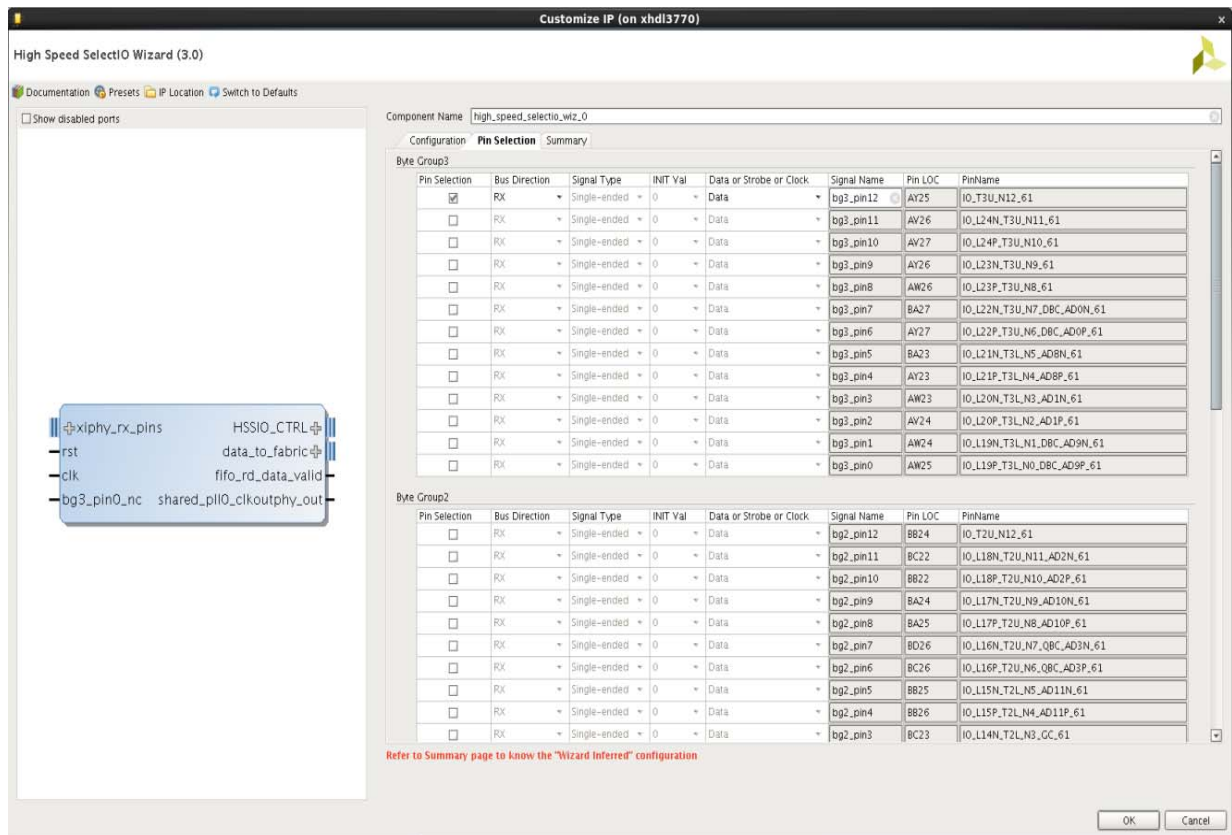

Figure 4-7: Pin Selection Tab (Only Byte group0 and Byte group1 (partially) are shown)

Byte Groupx (x is from 0 to 3). Byte group ordering is from Pin 0 to Pin 12 starting from Pin 0. The following description is applicable for all the byte groups unless specified.

Pin Selection

Enables the pin for selection. If P pin is differential, the N pin selection gets grayed out (Pin Name indicates whether pin is P or N, IO_L1P_T0L_). For example, Pin 0 is differential, Pin 1 selection gets grayed out. Pin 12 is always a single-ended pin.

Bus Direction

Sets the bus direction on the selected pin. Available options are:

- TX: Pin direction is set to TX; option is not available when **RX only** option is selected for **Bus Direction** under the Configuration tab.
- RX: Pin direction is set to RX; option is not available when **TX only** option is selected for **Bus Direction** under the Configuration tab.
- BIDIR (Beta): Pin direction is set to Bidirectional; option is not available in the following cases.
 - **TX only** or **RX only** is selected for **Bus Direction** under the Configuration tab.
 - **ASYNC/NONE/FRACTIONAL (Beta)** is selected for **RX External Clock and Data** under the Configuration tab.

Note: In case of differential pins,

- For the RX bus direction, both the P and N interface ports are available at the general interconnect and I/O interface.
- For the BiDir (Beta) and TX bus directions, both the P and N interface ports are available at the I/O interface and only P ports are available at the general interconnect interface.

Signal Type

Sets the signal type to differential or single ended, If the P pin is differential. the N pin is grayed out and is set to differential (Pin Name indicates whether pin is P or N, IO_L1P_T0L_).

Data/Strobe/Clock

Allows the pin to be selected as data/strobe/clock/input clock/Clk Fwd, If the P pin is differential the N pin gets grayed out and is set to the same value as the P pin.

- Data: Sets the pin as a data pin.
- Strobe/Clock: Sets the pin as a strobe pin, Only DBC/QBC/GC_QBC pins can be selected as a strobe. Pin Name indicates whether the pin is DBC/QBC/GC_QBC compatible. For example, IO_L1P_T0L_N0_DBC_44 indicates a DBC compatible pin. Only P pins can be set as a strobe.
- Clk Fwd: Valid only for the TX bus direction.
- Input Clock: Sets the pin as a clock pin. The input clock should be on this pin. Only GC/GC_QBC pins can be set as input clock pins. This option is available if **GC** is selected for **PLL Clock Source** under the Configuration tab.

StrobeP, StrobeN, InvStrobeP, InvStrobeN

When **Advanced Strobe/Clock Selection** is enabled, these options are available. Refer to [Clocking in Chapter 3](#) for more details.

Signal Name

Allows you to set the signal name. The signal name is appended with the corresponding pin position of the selected pin in the bank. I/O ports appear with this name and for the general interconnect it is appended to the data ports.

If **Append Pin No to signal names** is enabled, for example, if the signal name is `bg1_pin0`, the I/O port appears as `bg1_pin0_13`; 13 is the pin position (starting from 0 from byte group0). For the TX general interconnect interface the data port is `data_from_fabric_bg1_pin0_13`. For RX, the interface data port is `data_to_fabric_bg1_pin0_13`.

Init Val

Defines the initial value of the serialized data output of the TX_BITSLICE/RXTX_BITSLICE.

Pin LOC

LOC constraint for the pin used for setting the constraints in the XDC. This is grayed out.

Pin Name

Indicates the pin name in the bank, this is grayed out. Provides information about the pin. For example,

- P or N pin
- DBC/QBC/GC_QBC/GC pin
- Pin position in the byte group
- Pin is in Upper/Lower nibble in the byte group

Summary Tab

This tab display the overall summary of the configuration.

- Number of TX/RX/RXTX pins
- General interconnect clock frequency
- ClockOut Phy Frequency from PLL
- Inferred bitslices

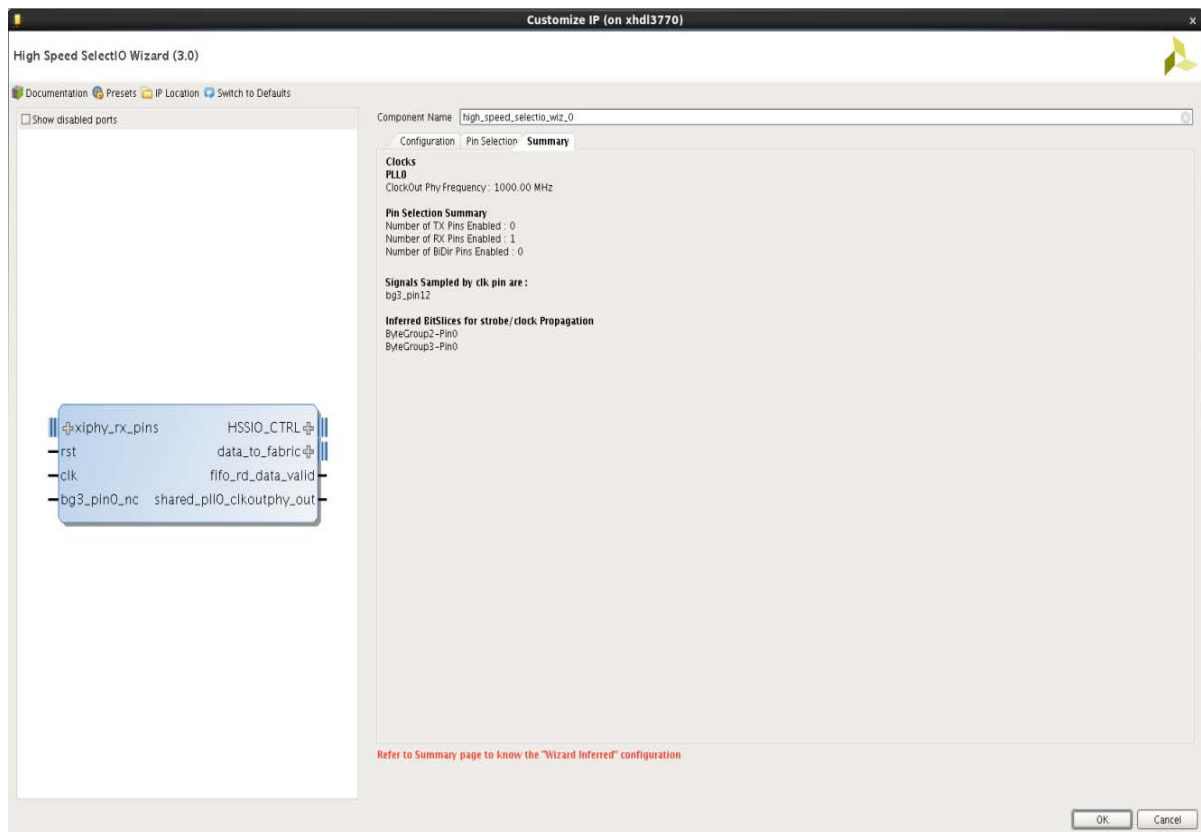

Figure 4-8: Summary Tab

User Parameters

Table 4-1 shows the relationship between the fields in the Vivado IDE and the User Parameters (which can be viewed in the Tcl Console).

Table 4-1: Vivado IDE Parameter to User Parameter Relationship

Vivado IDE Parameter/Value(1)	User Parameter/Value(1)	Default Value
Bus Direction Range: <ul style="list-style-type: none"> ◦ TX_ONLY: 0 ◦ RX_ONLY: 1 ◦ BiDir (Beta) or TX+RX or TX+RX+BiDir (Beta): 2 	BUS_DIR	0
Interface Speed (Mb/s) Range: 300-1,600 Mb/s	PLL0_DATA_SPEED	1,000
PLL Clk Input Frequency (MHz) Range: 70-1,099 MHz	PLL0_INPUT_CLK_FREQ	500.00
RX External Clock and Data Range: <ul style="list-style-type: none"> ◦ Edge DDR: 0 ◦ Center DDR: 1 ◦ ASYNC/NONE/FRACTIONAL (Beta): 2 ◦ Center DDR Strobe/Clock: 3 ◦ Edge DDR Strobe/Clock: 4 	PLL0_RX_EXTERNAL_CLK_TO_DATA	0
Enable Advanced Strobe/clock Selection Range <ul style="list-style-type: none"> ◦ FALSE: 0 ◦ TRUE: 1 	EN_ADV_STRB_SEL	0
ENABLE FIFO WRITE CLKOUT Range: <ul style="list-style-type: none"> ◦ FALSE: 0 ◦ TRUE: 1 	PLL0_FIFO_WRITE_CLK_OUT	0
PLL Clock Source Range: <ul style="list-style-type: none"> ◦ GC_Pin: IBUF_TO_PLL ◦ Fabric (Driven by BUFG): BUFG_TO_PLL 	PLL0_CLK_SOURCE	GC_Pin
BITSlice Serialization Factor Range: 4,8	SERIALIZATION_FACTOR	8
Select if PLL is included in core or Example Design Range: <ul style="list-style-type: none"> ◦ Include PLL in Core: 0 ◦ Include PLL in Example Design: 1 	PLL_SHARING	0

Table 4-1: Vivado IDE Parameter to User Parameter Relationship (Cont'd)

Vivado IDE Parameter/Value(1)	User Parameter/Value(1)	Default Value
Generate RIU Clock from PLL Range: <ul style="list-style-type: none"> ◦ FALSE: 0 ◦ TRUE: 1 	RIU_FROM_PLL	0
RX Delay Cascade Range: <ul style="list-style-type: none"> ◦ FALSE: 0 ◦ TRUE: 1 	RX_DELAY_CASCADE	0
RX Delay Type Range: <ul style="list-style-type: none"> ◦ FIXED: 0 ◦ VARIABLE: 1 ◦ VAR_LOAD: 2 	RX_DELAY_TYPE	0
RX Delay Value Range: 0 to 1,250	RX_DELAY_VALUE	0
TX Delay Type Range: <ul style="list-style-type: none"> ◦ FIXED: 0 ◦ VARIABLE: 1 ◦ VAR_LOAD: 2 	TX_DELAY_TYPE	1
TX Delay Value Range: 0 to 1.250	TX_DELAY_VALUE	0
Clock Forward Phase Range: <ul style="list-style-type: none"> ◦ FALSE: 0 ◦ TRUE: 1 	CLK_FWD_PHASE	0
Bank Range: Varies with device	BANK	45
Single Ended IO Standard Range: Varies with Differential IO Standard selected	SINGLE_IO_STD	NONE
Differential IO Standard Range: Varies with bank selection	DIFFERENTIAL_IO_STD	NONE
Single Ended Termination Range: Varies with Single Ended IO Standard	SINGLE_IO_TERMINATION	NONE
Differential Termination Range: Varies with Differential IO Standard	DIFFERENTIAL_IO_TERMINATION	NONE

Table 4-1: Vivado IDE Parameter to User Parameter Relationship (Cont'd)

Vivado IDE Parameter/Value(1)	User Parameter/Value(1)	Default Value
Single Ended Tx Pre-emphasis Range: Varies with Single Ended IO Standard	TX_PRE_EMPHASIS_S	NONE
Differential Tx Pre-emphasis Range: Varies with Differential IO Standard	TX_PRE_EMPHASIS_D	NONE
Append Pin No to IOs Range: <ul style="list-style-type: none"> ◦ False: 0 ◦ True: 1 	APPEND_PIN_NO	1
Single Ended Rx Equalization Range: Varies with Single Ended IO Standard	RX_EQUALIZATION_S	NONE
FIFO Read Enable User Control Range: <ul style="list-style-type: none"> ◦ False: 0 ◦ True: 1 	FIFO_RD_EN_CONTROL	0
Differential Rx Equalization Range: Varies with Differential IO Standard	RX_EQUALIZATION_D	NONE
RIU Interface Range: <ul style="list-style-type: none"> ◦ FALSE: 0 ◦ TRUE: 1 	ENABLE_RIU_INTERFACE	0
Enable BitSlip Range: <ul style="list-style-type: none"> ◦ FALSE: 0 ◦ TRUE: 1 	ENABLE_BITSLIP	0
Data 3-state <ul style="list-style-type: none"> ◦ Serialized: 0 ◦ Combinatorial: 1 	DATA_TRISTATE	1
Strobe/Clock 3-state <ul style="list-style-type: none"> ◦ Serialized: 0 ◦ Combinatorial: 1 	CLOCK_TRISTATE	1
bus dir1 Range: <ul style="list-style-type: none"> ◦ TX ◦ RX ◦ BiDir (Beta) 	BYTE0_PIN0_BUS_DIR	RX

Table 4-1: Vivado IDE Parameter to User Parameter Relationship (Cont'd)

Vivado IDE Parameter/Value(1)	User Parameter/Value(1)	Default Value
bus dir2 Range: <ul style="list-style-type: none"> ◦ TX ◦ RX ◦ BiDir (Beta) 	BYTE0_PIN1_BUS_DIR	RX
bus dir3 Range: <ul style="list-style-type: none"> ◦ TX ◦ RX ◦ BiDir (Beta) 	BYTE0_PIN2_BUS_DIR	RX
bus dir4 Range: <ul style="list-style-type: none"> ◦ TX ◦ RX ◦ BiDir (Beta) 	BYTE0_PIN3_BUS_DIR	RX
bus dir5 Range: <ul style="list-style-type: none"> ◦ TX ◦ RX ◦ BiDir (Beta) 	BYTE0_PIN4_BUS_DIR	RX
bus dir6 Range: <ul style="list-style-type: none"> ◦ TX ◦ RX ◦ BiDir (Beta) 	BYTE0_PIN5_BUS_DIR	RX
bus dir7 Range: <ul style="list-style-type: none"> ◦ TX ◦ RX ◦ BiDir (Beta) 	BYTE0_PIN6_BUS_DIR	RX
bus dir8 Range: <ul style="list-style-type: none"> ◦ TX ◦ RX ◦ BiDir (Beta) 	BYTE0_PIN7_BUS_DIR	RX
bus dir9 Range: <ul style="list-style-type: none"> ◦ TX ◦ RX ◦ BiDir (Beta) 	BYTE0_PIN8_BUS_DIR	RX

Table 4-1: Vivado IDE Parameter to User Parameter Relationship (Cont'd)

Vivado IDE Parameter/Value(1)	User Parameter/Value(1)	Default Value
bus dir10 Range: <ul style="list-style-type: none"> ◦ TX ◦ RX ◦ BiDir (Beta) 	BYTE0_PIN9_BUS_DIR	RX
bus dir11 Range: <ul style="list-style-type: none"> ◦ TX ◦ RX ◦ BiDir (Beta) 	BYTE0_PIN10_BUS_DIR	RX
bus dir12 Range: <ul style="list-style-type: none"> ◦ TX ◦ RX ◦ BiDir (Beta) 	BYTE0_PIN11_BUS_DIR	RX
bus dir13 Range: <ul style="list-style-type: none"> ◦ TX ◦ RX ◦ BiDir (Beta) 	BYTE0_PIN12_BUS_DIR	RX
Data Strobe/Clock1 Range: <ul style="list-style-type: none"> ◦ Data ◦ Strobe/Clock ◦ Clk Fwd: Clk Fwd 	BYTE0_PIN0_DATA_STROBE	Data
Data Strobe/Clock2 Range: <ul style="list-style-type: none"> ◦ Data ◦ Strobe/Clock ◦ Clk Fwd: Clk Fwd 	BYTE0_PIN1_DATA_STROBE	Data
Data Strobe/Clock3 Range: <ul style="list-style-type: none"> ◦ Data ◦ Clk Fwd: Clk Fwd 	BYTE0_PIN2_DATA_STROBE	Data
Data Strobe/Clock4 Range: <ul style="list-style-type: none"> ◦ Data ◦ Clk Fwd: Clk Fwd 	BYTE0_PIN3_DATA_STROBE	Data
Data Strobe/Clock5 Range: <ul style="list-style-type: none"> ◦ Data ◦ Clk Fwd: Clk Fwd 	BYTE0_PIN4_DATA_STROBE	Data

Table 4-1: Vivado IDE Parameter to User Parameter Relationship (Cont'd)

Vivado IDE Parameter/Value(1)	User Parameter/Value(1)	Default Value
Data Strobe/Clock6 Range: <ul style="list-style-type: none"> ◦ Data ◦ Clk Fwd: Clk Fwd 	BYTE0_PIN5_DATA_STROBE	Data
Data Strobe/Clock7 Range: <ul style="list-style-type: none"> ◦ Data ◦ Strobe/Clock ◦ Clk Fwd: Clk Fwd 	BYTE0_PIN6_DATA_STROBE	Data
Data Strobe/Clock8 Range: <ul style="list-style-type: none"> ◦ Data ◦ Strobe/Clock ◦ Clk Fwd: Clk Fwd 	BYTE0_PIN7_DATA_STROBE	Data
Data Strobe/Clock9 Range: <ul style="list-style-type: none"> ◦ Data ◦ Clk Fwd: Clk Fwd 	BYTE0_PIN8_DATA_STROBE	Data
Data Strobe/Clock10 Range: <ul style="list-style-type: none"> ◦ Data ◦ Clk Fwd: Clk Fwd 	BYTE0_PIN9_DATA_STROBE	Data
Data Strobe/Clock11 Range: <ul style="list-style-type: none"> ◦ Data ◦ Clk Fwd: Clk Fwd 	BYTE0_PIN10_DATA_STROBE	Data
Data Strobe/Clock12 Range: <ul style="list-style-type: none"> ◦ Data ◦ Clk Fwd: Clk Fwd 	BYTE0_PIN11_DATA_STROBE	Data
Data Strobe/Clock13 Range: <ul style="list-style-type: none"> ◦ Data ◦ Clk Fwd: Clk Fwd 	BYTE0_PIN12_DATA_STROBE	Data
Bus Sig Type1 Range: <ul style="list-style-type: none"> ◦ Differential: DIFF ◦ Single-ended: SINGLE 	BYTE0_PIN0_SIG_TYPE	Single-ended
Bus Sig Type2 Range: <ul style="list-style-type: none"> ◦ Differential: DIFF ◦ Single-ended: SINGLE 	BYTE0_PIN1_SIG_TYPE	Single-ended

Table 4-1: Vivado IDE Parameter to User Parameter Relationship (Cont'd)

Vivado IDE Parameter/Value(1)	User Parameter/Value(1)	Default Value
Bus Sig Type3 Range: <ul style="list-style-type: none"> ◦ Differential: DIFF ◦ Single-ended: SINGLE 	BYTE0_PIN2_SIG_TYPE	Single-ended
Bus Sig Type4 Range: <ul style="list-style-type: none"> ◦ Differential: DIFF ◦ Single-ended: SINGLE 	BYTE0_PIN3_SIG_TYPE	Single-ended
Bus Sig Type5 Range: <ul style="list-style-type: none"> ◦ Differential: DIFF ◦ Single-ended: SINGLE 	BYTE0_PIN4_SIG_TYPE	Single-ended
Bus Sig Type6 Range: <ul style="list-style-type: none"> ◦ Differential: DIFF ◦ Single-ended: SINGLE 	BYTE0_PIN5_SIG_TYPE	Single-ended
Bus Sig Type7 Range: <ul style="list-style-type: none"> ◦ Differential: DIFF ◦ Single-ended: SINGLE 	BYTE0_PIN6_SIG_TYPE	Single-ended
Bus Sig Type8 Range: <ul style="list-style-type: none"> ◦ Differential: DIFF ◦ Single-ended: SINGLE 	BYTE0_PIN7_SIG_TYPE	Single-ended
Bus Sig Type9 Range: <ul style="list-style-type: none"> ◦ Differential: DIFF ◦ Single-ended: SINGLE 	BYTE0_PIN8_SIG_TYPE	Single-ended
Bus Sig Type10 Range: <ul style="list-style-type: none"> ◦ Differential: DIFF ◦ Single-ended: SINGLE 	BYTE0_PIN9_SIG_TYPE	Single-ended
Bus Sig Type11 Range: <ul style="list-style-type: none"> ◦ Differential: DIFF ◦ Single-ended: SINGLE 	BYTE0_PIN10_SIG_TYPE	Single-ended
Bus Sig Type12 Range: <ul style="list-style-type: none"> ◦ Differential: DIFF ◦ Single-ended: SINGLE 	BYTE0_PIN11_SIG_TYPE	Single-ended

Table 4-1: Vivado IDE Parameter to User Parameter Relationship (Cont'd)

Vivado IDE Parameter/Value(1)	User Parameter/Value(1)	Default Value
Bus Sig Type13 Range: Single-ended: SINGLE	BYTE0_PIN12_SIG_TYPE	Single-ended
Byte Group0 Pin Selection1 Range: <ul style="list-style-type: none"> ◦ TRUE ◦ FALSE 	ENABLE_BYTE0_PIN0	FALSE
Byte Group0 Pin Selection2 Range: <ul style="list-style-type: none"> ◦ TRUE ◦ FALSE 	ENABLE_BYTE0_PIN1	FALSE
Byte Group0 Pin Selection3 Range: <ul style="list-style-type: none"> ◦ TRUE ◦ FALSE 	ENABLE_BYTE0_PIN2	FALSE
Byte Group0 Pin Selection4 Range: <ul style="list-style-type: none"> ◦ TRUE ◦ FALSE 	ENABLE_BYTE0_PIN3	FALSE
Byte Group0 Pin Selection5 Range: <ul style="list-style-type: none"> ◦ TRUE ◦ FALSE 	ENABLE_BYTE0_PIN4	FALSE
Byte Group0 Pin Selection6 Range: <ul style="list-style-type: none"> ◦ TRUE ◦ FALSE 	ENABLE_BYTE0_PIN5	FALSE
Byte Group0 Pin Selection7 Range: <ul style="list-style-type: none"> ◦ TRUE ◦ FALSE 	ENABLE_BYTE0_PIN6	FALSE
Byte Group0 Pin Selection8 Range: <ul style="list-style-type: none"> ◦ TRUE ◦ FALSE 	ENABLE_BYTE0_PIN7	FALSE
Byte Group0 Pin Selection9 Range: <ul style="list-style-type: none"> ◦ TRUE ◦ FALSE 	ENABLE_BYTE0_PIN8	FALSE

Table 4-1: Vivado IDE Parameter to User Parameter Relationship (Cont'd)

Vivado IDE Parameter/Value(1)	User Parameter/Value(1)	Default Value
Byte Group0 Pin Selection10 Range: <ul style="list-style-type: none"> ◦ TRUE ◦ FALSE 	ENABLE_BYTE0_PIN9	FALSE
Byte Group0 Pin Selection11 Range: <ul style="list-style-type: none"> ◦ TRUE ◦ FALSE 	ENABLE_BYTE0_PIN10	FALSE
Byte Group0 Pin Selection12 Range: <ul style="list-style-type: none"> ◦ TRUE ◦ FALSE 	ENABLE_BYTE0_PIN11	FALSE
Byte Group0 Pin Selection13 Range: <ul style="list-style-type: none"> ◦ TRUE ◦ FALSE 	ENABLE_BYTE0_PIN12	FALSE
Byte Group0 Signal Name1	BYTE0_PIN0_SIGNAL_NAME	bg0_pin0
Byte Group0 Signal Name2	BYTE0_PIN1_SIGNAL_NAME	bg0_pin1
Byte Group0 Signal Name3	BYTE0_PIN2_SIGNAL_NAME	bg0_pin2
Byte Group0 Signal Name4	BYTE0_PIN3_SIGNAL_NAME	bg0_pin3
Byte Group0 Signal Name5	BYTE0_PIN4_SIGNAL_NAME	bg0_pin4
Byte Group0 Signal Name6	BYTE0_PIN5_SIGNAL_NAME	bg0_pin5
Byte Group0 Signal Name7	BYTE0_PIN6_SIGNAL_NAME	bg0_pin6
Byte Group0 Signal Name8	BYTE0_PIN7_SIGNAL_NAME	bg0_pin7
Byte Group0 Signal Name9	BYTE0_PIN8_SIGNAL_NAME	bg0_pin8
Byte Group0 Signal Name10	BYTE0_PIN9_SIGNAL_NAME	bg0_pin9
Byte Group0 Signal Name11	BYTE0_PIN10_SIGNAL_NAME	bg0_pin10
Byte Group0 Signal Name12	BYTE0_PIN11_SIGNAL_NAME	bg0_pin11
Byte Group0 Signal Name13	BYTE0_PIN12_SIGNAL_NAME	bg0_pin12
bus dir1 Range: <ul style="list-style-type: none"> ◦ TX ◦ RX ◦ BiDir (Beta) 	BYTE1_PIN0_BUS_DIR	RX
bus dir2 Range: <ul style="list-style-type: none"> ◦ TX ◦ RX ◦ BiDir (Beta) 	BYTE1_PIN1_BUS_DIR	RX

Table 4-1: Vivado IDE Parameter to User Parameter Relationship (Cont'd)

Vivado IDE Parameter/Value(1)	User Parameter/Value(1)	Default Value
bus dir3 Range: <ul style="list-style-type: none"> ◦ TX ◦ RX ◦ BiDir (Beta) 	BYTE1_PIN2_BUS_DIR	RX
bus dir4 Range: <ul style="list-style-type: none"> ◦ TX ◦ RX ◦ BiDir (Beta) 	BYTE1_PIN3_BUS_DIR	RX
bus dir5 Range: <ul style="list-style-type: none"> ◦ TX ◦ RX ◦ BiDir (Beta) 	BYTE1_PIN4_BUS_DIR	RX
bus dir6 Range: <ul style="list-style-type: none"> ◦ TX ◦ RX ◦ BiDir (Beta) 	BYTE1_PIN5_BUS_DIR	RX
bus dir7 Range: <ul style="list-style-type: none"> ◦ TX ◦ RX ◦ BiDir (Beta) 	BYTE1_PIN6_BUS_DIR	RX
bus dir8 Range: <ul style="list-style-type: none"> ◦ TX ◦ RX ◦ BiDir (Beta) 	BYTE1_PIN7_BUS_DIR	RX
bus dir9 Range: <ul style="list-style-type: none"> ◦ TX ◦ RX ◦ BiDir (Beta) 	BYTE1_PIN8_BUS_DIR	RX
bus dir10 Range: <ul style="list-style-type: none"> ◦ TX ◦ RX ◦ BiDir (Beta) 	BYTE1_PIN9_BUS_DIR	RX

Table 4-1: Vivado IDE Parameter to User Parameter Relationship (Cont'd)

Vivado IDE Parameter/Value(1)	User Parameter/Value(1)	Default Value
bus dir11 Range: <ul style="list-style-type: none"> ◦ TX ◦ RX ◦ BiDir (Beta) 	BYTE1_PIN10_BUS_DIR	RX
bus dir12 Range: <ul style="list-style-type: none"> ◦ TX ◦ RX ◦ BiDir (Beta) 	BYTE1_PIN11_BUS_DIR	RX
bus dir13 Range: <ul style="list-style-type: none"> ◦ TX ◦ RX ◦ BiDir (Beta) 	BYTE1_PIN12_BUS_DIR	RX
Data Strobe/Clock1 Range: <ul style="list-style-type: none"> ◦ Data ◦ Strobe/Clock ◦ Clk Fwd: Clk Fwd 	BYTE1_PIN0_DATA_STROBE	Data
Data Strobe/Clock2 Range: <ul style="list-style-type: none"> ◦ Data ◦ Strobe/Clock ◦ Clk Fwd: Clk Fwd 	BYTE1_PIN1_DATA_STROBE	Data
Data Strobe/Clock3 Range: <ul style="list-style-type: none"> ◦ Data ◦ Clk Fwd: Clk Fwd 	BYTE1_PIN2_DATA_STROBE	Data
Data Strobe/Clock4 Range: <ul style="list-style-type: none"> ◦ Data ◦ Clk Fwd: Clk Fwd 	BYTE1_PIN3_DATA_STROBE	Data
Data Strobe/Clock5 Range: <ul style="list-style-type: none"> ◦ Data ◦ Clk Fwd: Clk Fwd 	BYTE1_PIN4_DATA_STROBE	Data
Data Strobe/Clock6 Range: <ul style="list-style-type: none"> ◦ Data ◦ Clk Fwd: Clk Fwd 	BYTE1_PIN5_DATA_STROBE	Data

Table 4-1: Vivado IDE Parameter to User Parameter Relationship (Cont'd)

Vivado IDE Parameter/Value(1)	User Parameter/Value(1)	Default Value
Data Strobe/Clock7 Range: <ul style="list-style-type: none"> ◦ Data ◦ Strobe/Clock ◦ Clk Fwd: Clk Fwd 	BYTE1_PIN6_DATA_STROBE	Data
Data Strobe/Clock8 Range: <ul style="list-style-type: none"> ◦ Data ◦ Strobe/Clock ◦ Clk Fwd: Clk Fwd ◦ Input Clock: Input Clock 	BYTE1_PIN7_DATA_STROBE	Data
Data Strobe/Clock9 Range: <ul style="list-style-type: none"> ◦ Data ◦ Clk Fwd: Clk Fwd 	BYTE1_PIN8_DATA_STROBE	Data
Data Strobe/Clock10 Range: <ul style="list-style-type: none"> ◦ Data ◦ Clk Fwd: Clk Fwd 	BYTE1_PIN9_DATA_STROBE	Data
Data Strobe/Clock11 Range: <ul style="list-style-type: none"> ◦ Data ◦ Clk Fwd: Clk Fwd ◦ Input Clock: Input Clock 	BYTE1_PIN10_DATA_STROBE	Data
Data Strobe/Clock12 Range: <ul style="list-style-type: none"> ◦ Data ◦ Clk Fwd: Clk Fwd 	BYTE1_PIN11_DATA_STROBE	Data
Data Strobe/Clock13 Range: <ul style="list-style-type: none"> ◦ Data ◦ Clk Fwd: Clk Fwd 	BYTE1_PIN12_DATA_STROBE	Data
Bus Sig Type1 Range: <ul style="list-style-type: none"> ◦ Differential: DIFF ◦ Single-ended: SINGLE 	BYTE1_PIN0_SIG_TYPE	Single-ended
Bus Sig Type2 Range: <ul style="list-style-type: none"> ◦ Differential: DIFF ◦ Single-ended: SINGLE 	BYTE1_PIN1_SIG_TYPE	Single-ended

Table 4-1: Vivado IDE Parameter to User Parameter Relationship (Cont'd)

Vivado IDE Parameter/Value(1)	User Parameter/Value(1)	Default Value
Bus Sig Type3 Range: <ul style="list-style-type: none"> ◦ Differential: DIFF ◦ Single-ended: SINGLE 	BYTE1_PIN2_SIG_TYPE	Single-ended
Bus Sig Type4 Range: <ul style="list-style-type: none"> ◦ Differential: DIFF ◦ Single-ended: SINGLE 	BYTE1_PIN3_SIG_TYPE	Single-ended
Bus Sig Type5 Range: <ul style="list-style-type: none"> ◦ Differential: DIFF ◦ Single-ended: SINGLE 	BYTE1_PIN4_SIG_TYPE	Single-ended
Bus Sig Type6 Range: <ul style="list-style-type: none"> ◦ Differential: DIFF ◦ Single-ended: SINGLE 	BYTE1_PIN5_SIG_TYPE	Single-ended
Bus Sig Type7 Range: <ul style="list-style-type: none"> ◦ Differential: DIFF ◦ Single-ended: SINGLE 	BYTE1_PIN6_SIG_TYPE	Single-ended
Bus Sig Type8 Range: <ul style="list-style-type: none"> ◦ Differential: DIFF ◦ Single-ended: SINGLE 	BYTE1_PIN7_SIG_TYPE	Single-ended
Bus Sig Type9 Range: <ul style="list-style-type: none"> ◦ Differential: DIFF ◦ Single-ended: SINGLE 	BYTE1_PIN8_SIG_TYPE	Single-ended
Bus Sig Type10 Range: <ul style="list-style-type: none"> ◦ Differential: DIFF ◦ Single-ended: SINGLE 	BYTE1_PIN9_SIG_TYPE	Single-ended
Bus Sig Type11 Range: <ul style="list-style-type: none"> ◦ Differential: DIFF ◦ Single-ended: SINGLE 	BYTE1_PIN10_SIG_TYPE	Single-ended
Bus Sig Type12 Range: <ul style="list-style-type: none"> ◦ Differential: DIFF ◦ Single-ended: SINGLE 	BYTE1_PIN11_SIG_TYPE	Single-ended

Table 4-1: Vivado IDE Parameter to User Parameter Relationship (Cont'd)

Vivado IDE Parameter/Value(1)	User Parameter/Value(1)	Default Value
Bus Sig Type13 Range: Single-ended: SINGLE	BYTE1_PIN12_SIG_TYPE	Single-ended
Byte group1 Pin Selection1 Range: <ul style="list-style-type: none"> ◦ TRUE ◦ FALSE 	ENABLE_BYTE1_PIN0	FALSE
Byte group1 Pin Selection2 Range: <ul style="list-style-type: none"> ◦ TRUE ◦ FALSE 	ENABLE_BYTE1_PIN1	FALSE
Byte group1 Pin Selection3 Range: <ul style="list-style-type: none"> ◦ TRUE ◦ FALSE 	ENABLE_BYTE1_PIN2	FALSE
Byte group1 Pin Selection4 Range: <ul style="list-style-type: none"> ◦ TRUE ◦ FALSE 	ENABLE_BYTE1_PIN3	FALSE
Byte group1 Pin Selection5 Range: <ul style="list-style-type: none"> ◦ TRUE ◦ FALSE 	ENABLE_BYTE1_PIN4	FALSE
Byte group1 Pin Selection6 Range: <ul style="list-style-type: none"> ◦ TRUE ◦ FALSE 	ENABLE_BYTE1_PIN5	FALSE
Byte group1 Pin Selection7 Range: <ul style="list-style-type: none"> ◦ TRUE ◦ FALSE 	ENABLE_BYTE1_PIN6	FALSE
Byte group1 Pin Selection8 Range: <ul style="list-style-type: none"> ◦ TRUE ◦ FALSE 	ENABLE_BYTE1_PIN7	FALSE
Byte group1 Pin Selection9 Range: <ul style="list-style-type: none"> ◦ TRUE ◦ FALSE 	ENABLE_BYTE1_PIN8	FALSE

Table 4-1: Vivado IDE Parameter to User Parameter Relationship (Cont'd)

Vivado IDE Parameter/Value(1)	User Parameter/Value(1)	Default Value
Byte group1 Pin Selection10 Range: <ul style="list-style-type: none"> ◦ TRUE ◦ FALSE 	ENABLE_BYTE1_PIN9	FALSE
Byte group1 Pin Selection11 Range: <ul style="list-style-type: none"> ◦ TRUE ◦ FALSE 	ENABLE_BYTE1_PIN10	FALSE
Byte group1 Pin Selection12 Range: <ul style="list-style-type: none"> ◦ TRUE ◦ FALSE 	ENABLE_BYTE1_PIN11	FALSE
Byte group1 Pin Selection13 Range: <ul style="list-style-type: none"> ◦ TRUE ◦ FALSE 	ENABLE_BYTE1_PIN12	FALSE
Byte Group1 Signal Name1	BYTE1_PIN0_SIGNAL_NAME	bg1_pin0
Byte Group1 Signal Name2	BYTE1_PIN1_SIGNAL_NAME	bg1_pin1
Byte Group1 Signal Name3	BYTE1_PIN2_SIGNAL_NAME	bg1_pin2
Byte Group1 Signal Name4	BYTE1_PIN3_SIGNAL_NAME	bg1_pin3
Byte Group1 Signal Name5	BYTE1_PIN4_SIGNAL_NAME	bg1_pin4
Byte Group1 Signal Name6	BYTE1_PIN5_SIGNAL_NAME	bg1_pin5
Byte Group1 Signal Name7	BYTE1_PIN6_SIGNAL_NAME	bg1_pin6
Byte Group1 Signal Name8	BYTE1_PIN7_SIGNAL_NAME	bg1_pin7
Byte Group1 Signal Name9	BYTE1_PIN8_SIGNAL_NAME	bg1_pin8
Byte Group1 Signal Name10	BYTE1_PIN9_SIGNAL_NAME	bg1_pin9
Byte Group1 Signal Name11	BYTE1_PIN10_SIGNAL_NAME	bg1_pin10
Byte Group1 Signal Name12	BYTE1_PIN11_SIGNAL_NAME	bg1_pin11
Byte Group1 Signal Name13	BYTE1_PIN12_SIGNAL_NAME	bg1_pin12
bus dir1 Range: <ul style="list-style-type: none"> ◦ TX ◦ RX ◦ BiDir (Beta) 	BYTE2_PIN0_BUS_DIR	RX
bus dir2 Range: <ul style="list-style-type: none"> ◦ TX ◦ RX ◦ BiDir (Beta) 	BYTE2_PIN1_BUS_DIR	RX

Table 4-1: Vivado IDE Parameter to User Parameter Relationship (Cont'd)

Vivado IDE Parameter/Value(1)	User Parameter/Value(1)	Default Value
bus dir3 Range: <ul style="list-style-type: none"> ◦ TX ◦ RX ◦ BiDir (Beta) 	BYTE2_PIN2_BUS_DIR	RX
bus dir4 Range: <ul style="list-style-type: none"> ◦ TX ◦ RX ◦ BiDir (Beta) 	BYTE2_PIN3_BUS_DIR	RX
bus dir5 Range: <ul style="list-style-type: none"> ◦ TX ◦ RX ◦ BiDir (Beta) 	BYTE2_PIN4_BUS_DIR	RX
bus dir6 Range: <ul style="list-style-type: none"> ◦ TX ◦ RX ◦ BiDir (Beta) 	BYTE2_PIN5_BUS_DIR	RX
bus dir7 Range: <ul style="list-style-type: none"> ◦ TX ◦ RX ◦ BiDir (Beta) 	BYTE2_PIN6_BUS_DIR	RX
bus dir8 Range: <ul style="list-style-type: none"> ◦ TX ◦ RX ◦ BiDir (Beta) 	BYTE2_PIN7_BUS_DIR	RX
bus dir9 Range: <ul style="list-style-type: none"> ◦ TX ◦ RX ◦ BiDir (Beta) 	BYTE2_PIN8_BUS_DIR	RX
bus dir10 Range: <ul style="list-style-type: none"> ◦ TX ◦ RX ◦ BiDir (Beta) 	BYTE2_PIN9_BUS_DIR	RX

Table 4-1: Vivado IDE Parameter to User Parameter Relationship (Cont'd)

Vivado IDE Parameter/Value(1)	User Parameter/Value(1)	Default Value
bus dir11 Range: <ul style="list-style-type: none"> ◦ TX ◦ RX ◦ BiDir (Beta) 	BYTE2_PIN10_BUS_DIR	RX
bus dir12 Range: <ul style="list-style-type: none"> ◦ TX ◦ RX ◦ BiDir (Beta) 	BYTE2_PIN11_BUS_DIR	RX
bus dir13 Range: <ul style="list-style-type: none"> ◦ TX ◦ RX ◦ BiDir (Beta) 	BYTE2_PIN12_BUS_DIR	RX
Data Strobe/Clock1 Range: <ul style="list-style-type: none"> ◦ Data ◦ Strobe/Clock ◦ Clk Fwd: Clk Fwd ◦ Input Clock: Input Clock 	BYTE2_PIN0_DATA_STROBE	Data
Data Strobe/Clock2 Range: <ul style="list-style-type: none"> ◦ Data ◦ Strobe/Clock ◦ Clk Fwd: Clk Fwd 	BYTE2_PIN1_DATA_STROBE	Data
Data Strobe/Clock3 Range: <ul style="list-style-type: none"> ◦ Data ◦ Clk Fwd: Clk Fwd ◦ Input Clock: Input Clock 	BYTE2_PIN2_DATA_STROBE	Data
Data Strobe/Clock4 Range: <ul style="list-style-type: none"> ◦ Data ◦ Clk Fwd: Clk Fwd 	BYTE2_PIN3_DATA_STROBE	Data
Data Strobe/Clock5 Range: <ul style="list-style-type: none"> ◦ Data ◦ Clk Fwd: Clk Fwd 	BYTE2_PIN4_DATA_STROBE	Data

Table 4-1: Vivado IDE Parameter to User Parameter Relationship (Cont'd)

Vivado IDE Parameter/Value(1)	User Parameter/Value(1)	Default Value
Data Strobe/Clock6 Range: <ul style="list-style-type: none"> ◦ Data ◦ Clk Fwd: Clk Fwd 	BYTE2_PIN5_DATA_STROBE	Data
Data Strobe/Clock7 Range: <ul style="list-style-type: none"> ◦ Data ◦ Strobe/Clock ◦ Clk Fwd: Clk Fwd 	BYTE2_PIN6_DATA_STROBE	Data
Data Strobe/Clock8 Range: <ul style="list-style-type: none"> ◦ Data ◦ Strobe/Clock ◦ Clk Fwd: Clk Fwd 	BYTE2_PIN7_DATA_STROBE	Data
Data Strobe/Clock9 Range: <ul style="list-style-type: none"> ◦ Data ◦ Clk Fwd: Clk Fwd 	BYTE2_PIN8_DATA_STROBE	Data
Data Strobe/Clock10 Range: <ul style="list-style-type: none"> ◦ Data ◦ Clk Fwd: Clk Fwd 	BYTE2_PIN9_DATA_STROBE	Data
Data Strobe/Clock11 Range: <ul style="list-style-type: none"> ◦ Data ◦ Clk Fwd: Clk Fwd 	BYTE2_PIN10_DATA_STROBE	Data
Data Strobe/Clock12 Range: <ul style="list-style-type: none"> ◦ Data ◦ Clk Fwd: Clk Fwd 	BYTE2_PIN11_DATA_STROBE	Data
Data Strobe/Clock13 Range: <ul style="list-style-type: none"> ◦ Data ◦ Clk Fwd: Clk Fwd 	BYTE2_PIN12_DATA_STROBE	Data
Bus Sig Type1 Range: <ul style="list-style-type: none"> ◦ Differential: DIFF ◦ Single-ended: SINGLE 	BYTE2_PIN0_SIG_TYPE	Single-ended
Bus Sig Type2 Range: <ul style="list-style-type: none"> ◦ Differential: DIFF ◦ Single-ended: SINGLE 	BYTE2_PIN1_SIG_TYPE	Single-ended

Table 4-1: Vivado IDE Parameter to User Parameter Relationship (Cont'd)

Vivado IDE Parameter/Value(1)	User Parameter/Value(1)	Default Value
Bus Sig Type3 Range: <ul style="list-style-type: none"> ◦ Differential: DIFF ◦ Single-ended: SINGLE 	BYTE2_PIN2_SIG_TYPE	Single-ended
Bus Sig Type4 Range: <ul style="list-style-type: none"> ◦ Differential: DIFF ◦ Single-ended: SINGLE 	BYTE2_PIN3_SIG_TYPE	Single-ended
Bus Sig Type5 Range: <ul style="list-style-type: none"> ◦ Differential: DIFF ◦ Single-ended: SINGLE 	BYTE2_PIN4_SIG_TYPE	Single-ended
Bus Sig Type6 Range: <ul style="list-style-type: none"> ◦ Differential: DIFF ◦ Single-ended: SINGLE 	BYTE2_PIN5_SIG_TYPE	Single-ended
Bus Sig Type7 Range: <ul style="list-style-type: none"> ◦ Differential: DIFF ◦ Single-ended: SINGLE 	BYTE2_PIN6_SIG_TYPE	Single-ended
Bus Sig Type8 Range: <ul style="list-style-type: none"> ◦ Differential: DIFF ◦ Single-ended: SINGLE 	BYTE2_PIN7_SIG_TYPE	Single-ended
Bus Sig Type9 Range: <ul style="list-style-type: none"> ◦ Differential: DIFF ◦ Single-ended: SINGLE 	BYTE2_PIN8_SIG_TYPE	Single-ended
Bus Sig Type10 Range: <ul style="list-style-type: none"> ◦ Differential: DIFF ◦ Single-ended: SINGLE 	BYTE2_PIN9_SIG_TYPE	Single-ended
Bus Sig Type11 Range: <ul style="list-style-type: none"> ◦ Differential: DIFF ◦ Single-ended: SINGLE 	BYTE2_PIN10_SIG_TYPE	Single-ended
Bus Sig Type12 Range: <ul style="list-style-type: none"> ◦ Differential: DIFF ◦ Single-ended: SINGLE 	BYTE2_PIN11_SIG_TYPE	Single-ended

Table 4-1: Vivado IDE Parameter to User Parameter Relationship (Cont'd)

Vivado IDE Parameter/Value(1)	User Parameter/Value(1)	Default Value
Bus Sig Type13 Range: Single-ended: SINGLE	BYTE2_PIN12_SIG_TYPE	Single-ended
Byte group2 Pin Selection1 Range: <ul style="list-style-type: none"> ◦ TRUE ◦ FALSE 	ENABLE_BYTE2_PIN0	FALSE
Byte group2 Pin Selection2 Range: <ul style="list-style-type: none"> ◦ TRUE ◦ FALSE 	ENABLE_BYTE2_PIN1	FALSE
Byte group2 Pin Selection3 Range: <ul style="list-style-type: none"> ◦ TRUE ◦ FALSE 	ENABLE_BYTE2_PIN2	FALSE
Byte group2 Pin Selection4 Range: <ul style="list-style-type: none"> ◦ TRUE ◦ FALSE 	ENABLE_BYTE2_PIN3	FALSE
Byte group2 Pin Selection5 Range: <ul style="list-style-type: none"> ◦ TRUE ◦ FALSE 	ENABLE_BYTE2_PIN4	FALSE
Byte group2 Pin Selection6 Range: <ul style="list-style-type: none"> ◦ TRUE ◦ FALSE 	ENABLE_BYTE2_PIN5	FALSE
Byte group2 Pin Selection7 Range: <ul style="list-style-type: none"> ◦ TRUE ◦ FALSE 	ENABLE_BYTE2_PIN6	FALSE
Byte group2 Pin Selection8 Range: <ul style="list-style-type: none"> ◦ TRUE ◦ FALSE 	ENABLE_BYTE2_PIN7	FALSE
Byte group2 Pin Selection9 Range: <ul style="list-style-type: none"> ◦ TRUE ◦ FALSE 	ENABLE_BYTE2_PIN8	FALSE

Table 4-1: Vivado IDE Parameter to User Parameter Relationship (Cont'd)

Vivado IDE Parameter/Value(1)	User Parameter/Value(1)	Default Value
Byte group2 Pin Selection10 Range: <ul style="list-style-type: none"> ◦ TRUE ◦ FALSE 	ENABLE_BYTE2_PIN9	FALSE
Byte group2 Pin Selection11 Range: <ul style="list-style-type: none"> ◦ TRUE ◦ FALSE 	ENABLE_BYTE2_PIN10	FALSE
Byte group2 Pin Selection12 Range: <ul style="list-style-type: none"> ◦ TRUE ◦ FALSE 	ENABLE_BYTE2_PIN11	FALSE
Byte group2 Pin Selection13 Range: <ul style="list-style-type: none"> ◦ TRUE ◦ FALSE 	ENABLE_BYTE2_PIN12	FALSE
Byte Group2 Signal Name1	BYTE2_PIN0_SIGNAL_NAME	bg2_pin0
Byte Group2 Signal Name2	BYTE2_PIN1_SIGNAL_NAME	bg2_pin1
Byte Group2 Signal Name3	BYTE2_PIN2_SIGNAL_NAME	bg2_pin2
Byte Group2 Signal Name4	BYTE2_PIN3_SIGNAL_NAME	bg2_pin3
Byte Group2 Signal Name5	BYTE2_PIN4_SIGNAL_NAME	bg2_pin4
Byte Group2 Signal Name6	BYTE2_PIN5_SIGNAL_NAME	bg2_pin5
Byte Group2 Signal Name7	BYTE2_PIN6_SIGNAL_NAME	bg2_pin6
Byte Group2 Signal Name8	BYTE2_PIN7_SIGNAL_NAME	bg2_pin7
Byte Group2 Signal Name9	BYTE2_PIN8_SIGNAL_NAME	bg2_pin8
Byte Group2 Signal Name10	BYTE2_PIN9_SIGNAL_NAME	bg2_pin9
Byte Group2 Signal Name11	BYTE2_PIN10_SIGNAL_NAME	bg2_pin10
Byte Group2 Signal Name12	BYTE2_PIN11_SIGNAL_NAME	bg2_pin11
Byte Group2 Signal Name13	BYTE2_PIN12_SIGNAL_NAME	bg2_pin12
bus dir1 Range: <ul style="list-style-type: none"> ◦ TX ◦ RX ◦ BiDir (Beta) 	BYTE3_PIN0_BUS_DIR	RX
bus dir2 Range: <ul style="list-style-type: none"> ◦ TX ◦ RX ◦ BiDir (Beta) 	BYTE3_PIN1_BUS_DIR	RX

Table 4-1: Vivado IDE Parameter to User Parameter Relationship (Cont'd)

Vivado IDE Parameter/Value(1)	User Parameter/Value(1)	Default Value
bus dir3 Range: <ul style="list-style-type: none"> ◦ TX ◦ RX ◦ BiDir (Beta) 	BYTE3_PIN2_BUS_DIR	RX
bus dir4 Range: <ul style="list-style-type: none"> ◦ TX ◦ RX ◦ BiDir (Beta) 	BYTE3_PIN3_BUS_DIR	RX
bus dir5 Range: <ul style="list-style-type: none"> ◦ TX ◦ RX ◦ BiDir (Beta) 	BYTE3_PIN4_BUS_DIR	RX
bus dir6 Range: <ul style="list-style-type: none"> ◦ TX ◦ RX ◦ BiDir (Beta) 	BYTE3_PIN5_BUS_DIR	RX
bus dir7 Range: <ul style="list-style-type: none"> ◦ TX ◦ RX ◦ BiDir (Beta) 	BYTE3_PIN6_BUS_DIR	RX
bus dir8 Range: <ul style="list-style-type: none"> ◦ TX ◦ RX ◦ BiDir (Beta) 	BYTE3_PIN7_BUS_DIR	RX
bus dir9 Range: <ul style="list-style-type: none"> ◦ TX ◦ RX ◦ BiDir (Beta) 	BYTE3_PIN8_BUS_DIR	RX
bus dir10 Range: <ul style="list-style-type: none"> ◦ TX ◦ RX ◦ BiDir (Beta) 	BYTE3_PIN9_BUS_DIR	RX

Table 4-1: Vivado IDE Parameter to User Parameter Relationship (Cont'd)

Vivado IDE Parameter/Value(1)	User Parameter/Value(1)	Default Value
bus dir11 Range: <ul style="list-style-type: none"> ◦ TX ◦ RX ◦ BiDir (Beta) 	BYTE3_PIN10_BUS_DIR	RX
bus dir12 Range: <ul style="list-style-type: none"> ◦ TX ◦ RX ◦ BiDir (Beta) 	BYTE3_PIN11_BUS_DIR	RX
bus dir13 Range: <ul style="list-style-type: none"> ◦ TX ◦ RX ◦ BiDir (Beta) 	BYTE3_PIN12_BUS_DIR	RX
Data Strobe/Clock1 Range: <ul style="list-style-type: none"> ◦ Data ◦ Strobe/Clock ◦ Clk Fwd: Clk Fwd 	BYTE3_PIN0_DATA_STROBE	Data
Data Strobe/Clock2 Range: <ul style="list-style-type: none"> ◦ Data ◦ Strobe/Clock ◦ Clk Fwd: Clk Fwd 	BYTE3_PIN1_DATA_STROBE	Data
Data Strobe/Clock3 Range: <ul style="list-style-type: none"> ◦ Data ◦ Clk Fwd: Clk Fwd 	BYTE3_PIN2_DATA_STROBE	Data
Data Strobe/Clock4 Range: <ul style="list-style-type: none"> ◦ Data ◦ Clk Fwd: Clk Fwd 	BYTE3_PIN3_DATA_STROBE	Data
Data Strobe/Clock5 Range: <ul style="list-style-type: none"> ◦ Data ◦ Clk Fwd: Clk Fwd 	BYTE3_PIN4_DATA_STROBE	Data
Data Strobe/Clock6 Range: <ul style="list-style-type: none"> ◦ Data ◦ Clk Fwd: Clk Fwd 	BYTE3_PIN5_DATA_STROBE	Data

Table 4-1: Vivado IDE Parameter to User Parameter Relationship (Cont'd)

Vivado IDE Parameter/Value(1)	User Parameter/Value(1)	Default Value
Data Strobe/Clock7 Range: <ul style="list-style-type: none"> ◦ Data ◦ Strobe/Clock ◦ Clk Fwd: Clk Fwd 	BYTE3_PIN6_DATA_STROBE	Data
Data Strobe/Clock8 Range: <ul style="list-style-type: none"> ◦ Data ◦ Strobe/Clock ◦ Clk Fwd: Clk Fwd 	BYTE3_PIN7_DATA_STROBE	Data
Data Strobe/Clock9 Range: <ul style="list-style-type: none"> ◦ Data ◦ Clk Fwd: Clk Fwd 	BYTE3_PIN8_DATA_STROBE	Data
Data Strobe/Clock10 Range: <ul style="list-style-type: none"> ◦ Data ◦ Clk Fwd: Clk Fwd 	BYTE3_PIN9_DATA_STROBE	Data
Data Strobe/Clock11 Range: <ul style="list-style-type: none"> ◦ Data ◦ Clk Fwd: Clk Fwd 	BYTE3_PIN10_DATA_STROBE	Data
Data Strobe/Clock12 Range: <ul style="list-style-type: none"> ◦ Data ◦ Clk Fwd: Clk Fwd 	BYTE3_PIN11_DATA_STROBE	Data
Data Strobe/Clock13 Range: <ul style="list-style-type: none"> ◦ Data ◦ Clk Fwd: Clk Fwd 	BYTE3_PIN12_DATA_STROBE	Data
Bus Sig Type1 Range: <ul style="list-style-type: none"> ◦ Differential: DIFF ◦ Single-ended: SINGLE 	BYTE3_PIN0_SIG_TYPE	Single-ended
Bus Sig Type2 Range: <ul style="list-style-type: none"> ◦ Differential: DIFF ◦ Single-ended: SINGLE 	BYTE3_PIN1_SIG_TYPE	Single-ended
Bus Sig Type3 Range: <ul style="list-style-type: none"> ◦ Differential: DIFF ◦ Single-ended: SINGLE 	BYTE3_PIN2_SIG_TYPE	Single-ended

Table 4-1: Vivado IDE Parameter to User Parameter Relationship (Cont'd)

Vivado IDE Parameter/Value(1)	User Parameter/Value(1)	Default Value
Bus Sig Type4 Range: <ul style="list-style-type: none"> ◦ Differential: DIFF ◦ Single-ended: SINGLE 	BYTE3_PIN3_SIG_TYPE	Single-ended
Bus Sig Type5 Range: <ul style="list-style-type: none"> ◦ Differential: DIFF ◦ Single-ended: SINGLE 	BYTE3_PIN4_SIG_TYPE	Single-ended
Bus Sig Type6 Range: <ul style="list-style-type: none"> ◦ Differential: DIFF ◦ Single-ended: SINGLE 	BYTE3_PIN5_SIG_TYPE	Single-ended
Bus Sig Type7 Range: <ul style="list-style-type: none"> ◦ Differential: DIFF ◦ Single-ended: SINGLE 	BYTE3_PIN6_SIG_TYPE	Single-ended
Bus Sig Type8 Range: <ul style="list-style-type: none"> ◦ Differential: DIFF ◦ Single-ended: SINGLE 	BYTE3_PIN7_SIG_TYPE	Single-ended
Bus Sig Type9 Range: <ul style="list-style-type: none"> ◦ Differential: DIFF ◦ Single-ended: SINGLE 	BYTE3_PIN8_SIG_TYPE	Single-ended
Bus Sig Type10 Range: <ul style="list-style-type: none"> ◦ Differential: DIFF ◦ Single-ended: SINGLE 	BYTE3_PIN9_SIG_TYPE	Single-ended
Bus Sig Type11 Range: <ul style="list-style-type: none"> ◦ Differential: DIFF ◦ Single-ended: SINGLE 	BYTE3_PIN10_SIG_TYPE	Single-ended
Bus Sig Type12 Range: <ul style="list-style-type: none"> ◦ Differential: DIFF ◦ Single-ended: SINGLE 	BYTE3_PIN11_SIG_TYPE	Single-ended
Bus Sig Type13 Range: Single-ended: SINGLE	BYTE3_PIN12_SIG_TYPE	Single-ended

Table 4-1: Vivado IDE Parameter to User Parameter Relationship (Cont'd)

Vivado IDE Parameter/Value(1)	User Parameter/Value(1)	Default Value
Byte group3 Pin Selection1 Range: <ul style="list-style-type: none"> ◦ TRUE ◦ FALSE 	ENABLE_BYTE3_PIN0	FALSE
Byte group3 Pin Selection2 Range: <ul style="list-style-type: none"> ◦ TRUE ◦ FALSE 	ENABLE_BYTE3_PIN1	FALSE
Byte group3 Pin Selection3 Range: <ul style="list-style-type: none"> ◦ TRUE ◦ FALSE 	ENABLE_BYTE3_PIN2	FALSE
Byte group3 Pin Selection4 Range: <ul style="list-style-type: none"> ◦ TRUE ◦ FALSE 	ENABLE_BYTE3_PIN3	FALSE
Byte group3 Pin Selection5 Range: <ul style="list-style-type: none"> ◦ TRUE ◦ FALSE 	ENABLE_BYTE3_PIN4	FALSE
Byte group3 Pin Selection6 Range: <ul style="list-style-type: none"> ◦ TRUE ◦ FALSE 	ENABLE_BYTE3_PIN5	FALSE
Byte group3 Pin Selection7 Range: <ul style="list-style-type: none"> ◦ TRUE ◦ FALSE 	ENABLE_BYTE3_PIN6	FALSE
Byte group3 Pin Selection8 Range: <ul style="list-style-type: none"> ◦ TRUE ◦ FALSE 	ENABLE_BYTE3_PIN7	FALSE
Byte group3 Pin Selection9 Range: <ul style="list-style-type: none"> ◦ TRUE ◦ FALSE 	ENABLE_BYTE3_PIN8	FALSE
Byte group3 Pin Selection10 Range: <ul style="list-style-type: none"> ◦ TRUE ◦ FALSE 	ENABLE_BYTE3_PIN9	FALSE

Table 4-1: Vivado IDE Parameter to User Parameter Relationship (Cont'd)

Vivado IDE Parameter/Value(1)	User Parameter/Value(1)	Default Value
Byte group3 Pin Selection11 Range: <ul style="list-style-type: none"> ◦ TRUE ◦ FALSE 	ENABLE_BYTE3_PIN10	FALSE
Byte group3 Pin Selection12 Range: <ul style="list-style-type: none"> ◦ TRUE ◦ FALSE 	ENABLE_BYTE3_PIN11	FALSE
Byte group3 Pin Selection13 Range: <ul style="list-style-type: none"> ◦ TRUE ◦ FALSE 	ENABLE_BYTE3_PIN12	FALSE
Byte Group3 Signal Name1	BYTE3_PIN0_SIGNAL_NAME	bg3_pin0
Byte Group3 Signal Name2	BYTE3_PIN1_SIGNAL_NAME	bg3_pin1
Byte Group3 Signal Name3	BYTE3_PIN2_SIGNAL_NAME	bg3_pin2
Byte Group3 Signal Name4	BYTE3_PIN3_SIGNAL_NAME	bg3_pin3
Byte Group3 Signal Name5	BYTE3_PIN4_SIGNAL_NAME	bg3_pin4
Byte Group3 Signal Name6	BYTE3_PIN5_SIGNAL_NAME	bg3_pin5
Byte Group3 Signal Name7	BYTE3_PIN6_SIGNAL_NAME	bg3_pin6
Byte Group3 Signal Name8	BYTE3_PIN7_SIGNAL_NAME	bg3_pin7
Byte Group3 Signal Name9	BYTE3_PIN8_SIGNAL_NAME	bg3_pin8
Byte Group3 Signal Name10	BYTE3_PIN9_SIGNAL_NAME	bg3_pin9
Byte Group3 Signal Name11	BYTE3_PIN10_SIGNAL_NAME	bg3_pin10
Byte Group3 Signal Name12	BYTE3_PIN11_SIGNAL_NAME	bg3_pin11
Byte Group3 Signal Name13	BYTE3_PIN12_SIGNAL_NAME	bg3_pin12
INIT VAL1 to INIT VAL52 Range: <ul style="list-style-type: none"> ◦ 0 ◦ 1 	INIT_VAL	0

Output Generation

The core delivers Verilog RTL for the core logic, example design, and example test bench.

The following files are created when core is configured and output products are generated:

<ComponentName>.v - Top Level wrapper to be instantiated in User Design

- <ComponentName>_high_speed_selectio_wiz_v3_0.v - Top Level file to set the appropriate HDL parameters for a given configuration

- hssio_wiz_top.v - Top level file

- bs_top.v - Top level file for Bitslice and Bitslice Control Modules

- rxtx_bs.v - Instantiates RXTX_BITSLICE module

- tx_bs_tri.v - Instantiates TX_BITSLICE_TRI module

- tx_bs.v - Instantiates TX_BITSLICE module

- rx_bs.v - Instantiate RX_BITSLICE module

- BitSlipInLogic_Toplevel.v (Optional Module for BitSlip Operation)

- C2BCEtc.v

- C2BCEtc_dwnld.v

- C3BCEtc.v

- C3BCEtc_dwnld.v

- Fdcr.v

- GenPulse.v

- BitSlipInLogic_4b.v

- BitSlipInLogic_8b.v

- BitSlipInLogic_FstCmp_4b.v

- BitSlipInLogic_FstCmp_8b.v

- clk_rst_top.v - Instantiates Clock and Reset Modules

- rst_scheme.v - Reset Logic

- clk_scheme.v - Clocking Logic - Instantiates PLL
- bs_ctrl_top.v - Instantiates BITSlice_CONTROL module
- iobuf_top.v - Instantiates I/O Buffers for all Clock and Data Pins

If the IP example design project is opened, another core instance with the core name <ip_ex_inst> is instantiated in the <ComponentName>_exdes.v. For example design simulation, the <ComponentName>_tb.v test bench file is generated.

Constraining the Core

This section contains information about constraining the core in the Vivado Design Suite.

Required Constraints

Refer to the [I/O Standard Settings](#) in [Configuration Settings](#).

Device, Package, and Speed Grade Selections

Input clock frequency selection depends on the maximum frequencies supported by the BUFG. Select the device, package and speed grades after referring to the following data sheets for details on supported maximum frequencies.

- *Kintex UltraScale Architecture Data Sheet (DS892)* [\[Ref 2\]](#)
- *Virtex UltraScale FPGAs Data Sheet (DS893)* [\[Ref 3\]](#)
- *Kintex UltraScale+ FPGAs Data Sheet (DS922)* [\[Ref 4\]](#)

Clock Frequencies

The I/O logic for this core works in the range 300-800 Mb/s. The general interconnect logic for this core works up to 200 Mb/s.

Clock Management

All clocks are generated using PLL.



IMPORTANT: Core logic should be clocked with the divided version of the PLL output.

Clock Placement

The input clock can be placed on global clock pins with the name *_GC_*. For EDGE DDR/CENTER DDR, the clock is placed on *_GC_QBC* pin only.

Banking

This core can be used to configure an I/O circuit for High Range (HR) and High Performance (HP) banks. Available banks for the project part are provided in the Vivado IDE for selection. See [Customizing and Generating the Core](#) for more details.

Transceiver Placement

There are no transceiver placement constraints for this core.

I/O Standard and Placement

Note: The Wizard can infer some bitslices for strobe propagation in the RX and BiDir (Beta) bus configuration; these are displayed under the comment.

```
##### I/O constraints for Wizard inferred RX bitslice #####
```

For these bitslices, only the single-ended I/O standard is applicable. In case only differential pins are selected during configuration, ensure that the appropriate single ended I/O standard is set in the XDC file for inferred RX bit slice.

Refer to *UltraScale Architecture SelectIO Resources: Advance Specification User Guide* (UG571) [\[Ref 1\]](#) for the supported I/O standards.

Simulation

For comprehensive information about Vivado simulation components, as well as information about using supported third-party tools, see the *Vivado Design Suite User Guide: Logic Simulation* (UG900) [\[Ref 8\]](#).

Synthesis and Implementation

For details about synthesis and implementation, see the *Vivado Design Suite User Guide: Designing with IP* (UG896) [\[Ref 6\]](#).

Example Design

This chapter contains information about the example design provided in the Vivado® Design Suite.

This core provides an example design with one core instance and one example instance. For each configured pin of the IP instance, a counterpart (example design) is generated. When bitslip is enabled, the pre-defined training pattern is compared to align the data at RX. When data is aligned, 0xA5 and 0x5A patterns are sent for 8-bit serialization, and 0x5 and 0xA patterns are sent for 4-bit serialization per bitslice. When bitslip is not enabled, data from RX bitslices are unaligned data, and the example design checks for all possible valid data of RX for a known TX data pattern. If a pattern matches, `data_check_complete` output is asserted from the example design.

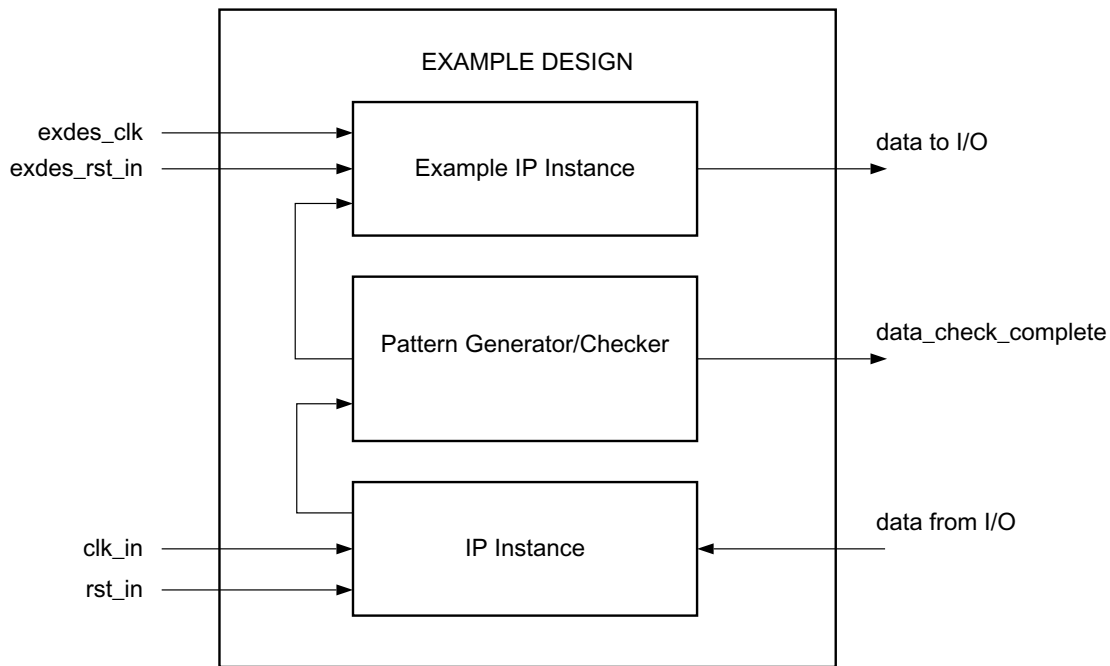

X14110

Figure 5-1: Example Design Block Diagram

Table 5-1: DUT and Partner IP Configurations

DUT Configuration	Partner IP Configuration
TX with no Clock Forward Pin	RX in Serial Mode
TX with Clock Forward Pin and Clock Forward Phase= 0	RX in Edge DDR mode
TX with Clock Forward Pin and Clock Forward Phase= 90	RX in Center DDR mode
RX – Edge DDR/ Center DDR	TX with Clock Forward Pin
RX – Edge DDR Strobe	TX with Clock Forward Pin and Clock Forward Phase = 0
RX – Center DDR Strobe	TX with Clock Forward Pin and Clock Forward Phase = 90
Mix of TX, RX and BiDir (Beta)	Supported only for the configurations given below.
Tx with no clock forward pin and interface speed less than 600 Mb/s	Not supported

Table 5-2: Configuration of DUT Supported in Example Design for Mix of Tx, Rx and BiDir (Beta) Pins

Mode	Max Tx/BIDIR Pins	Max Rx/BIDIR Pins	Comments
Tx + Rx BIDIR + Tx or BIDIR + Rx	26	26	Split at byte group boundary in partner
	39	13	Split at byte group boundary in partner
	13	39	Split at byte group boundary in partner

Table 5-3: Configuration of DUT Supported in Example Design for Tx, Rx and BiDir Pins

Mode	Max Tx Pins	Max Rx Pins	Max BIDIR Pins	Comments
Tx + Rx + BIDIR	26	13	13	Split at byte group boundary in partner
	13	13	26	Split at byte group boundary in partner
	13	26	13	Split at byte group boundary in partner

Test Bench

This chapter contains information about the test bench provided in the Vivado® Design Suite. The test bench is a simple Verilog code to exercise the example design and the core. This test bench performs the following tasks:

- Generates the input clock signals.
- Applies a reset to the example design.
- Example design RX and TX interfaces are looped back; similarly IP BiDir (Beta) bus and example design BIDIR buses are looped back. The waveform is shown for the TX/RX loopback for 1 pin.
- If an RX and TX pattern matches, the test bench sends a message for the successful test completion, as shown in [Figure 6-1](#). Otherwise, it waits for 16,000 cycles of input clock and sends a test failure message.
- Checks the alignment of data on the TX pin for source synchronous interfaces

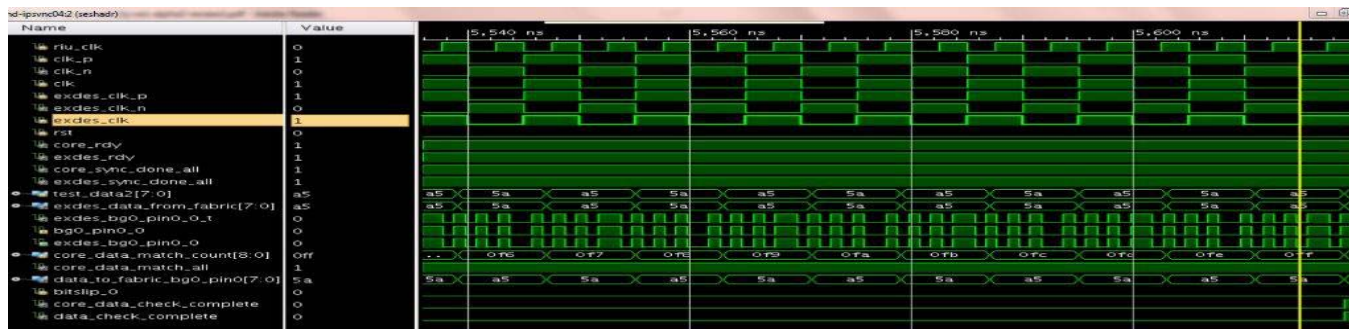

Figure 6-1: Test Bench Waveform

Verification, Compliance, and Interoperability

This appendix provides details about how this IP core was tested for compliance with the protocol to which it was designed.

Simulation

This core is verified with incisive enterprise simulator (IES), Verilog compiled simulator (VCS), Questa and XSIM simulators.

Hardware Testing

Hardware testing was performed on the KCU105 platform for the RX and TX configurations using the MicroBlaze™ processor system to generate the data pattern for the TX and check the data at the RX. The TX and RX pins were connected to an FMC 107 loopback card placed on an HPC connector onboard. Tests were performed on the supported data speed range.

Migrating and Upgrading

Migrating and upgrading are not possible from previous versions of the core. All the port names and Vivado® IDE parameters were changed in v3.0. Refer to AR [64216](#) for guidance on upgrading the core from previous version

Debugging

This appendix includes details about resources available on the Xilinx Support website and debugging tools.

Finding Help on Xilinx.com

To help in the design and debug process when using the High Speed SelectIO Wizard, the [Xilinx Support web page](#) contains key resources such as product documentation, release notes, answer records, information about known issues, and links for obtaining further product support.

Documentation

This product guide is the main document associated with the High Speed SelectIO Wizard. This guide, along with documentation related to all products that aid in the design process, can be found on the [Xilinx Support web page](#) or by using the Xilinx® Documentation Navigator.

Download the Xilinx Documentation Navigator from the [Downloads page](#). For more information about this tool and the features available, open the online help after installation.

Answer Records

Answer Records include information about commonly encountered problems, helpful information on how to resolve these problems, and any known issues with a Xilinx product. Answer Records are created and maintained daily ensuring that users have access to the most accurate information available.

Answer Records for this core can be located by using the Search Support box on the main [Xilinx support web page](#). To maximize your search results, use proper keywords such as

- Product name
- Tool message(s)
- Summary of the issue encountered

Master Answer Record: [64216](#)

Technical Support

Xilinx provides technical support in the [Xilinx Support web page](#) for this LogiCORE™ IP product when used as described in the product documentation. Xilinx cannot guarantee timing, functionality, or support if you do any of the following:

- Implement the solution in devices that are not defined in the documentation.
- Customize the solution beyond that allowed in the product documentation.
- Change any section of the design labeled DO NOT MODIFY.

To contact Xilinx Technical Support, navigate to the [Xilinx Support web page](#).

Vivado Design Suite Debug Feature

The Vivado® Design Suite debug feature inserts logic analyzer and virtual I/O cores directly into your design. The debug feature also allows you to set trigger conditions to capture application and integrated block port signals in hardware. Captured signals can then be analyzed. This feature in the Vivado IDE is used for logic debugging and validation of a design running in Xilinx.

The Vivado logic analyzer is used with the logic debug IP cores, including:

- integrated logic analyzer (ILA) 2.0 (and later versions)
- virtual input output (VIO) 2.0 (and later versions)

See the *Vivado Design Suite User Guide: Programming and Debugging* (UG908) [\[Ref 10\]](#).

Reference Boards

Various Xilinx development boards support the High Speed SelectIO Wizard. These boards can be used to prototype designs and establish that the core can communicate with the system. The UltraScale™ architecture evaluation board KCU105 is supported.

Hardware Debug

Hardware issues can range from link bring-up to problems seen after hours of testing. This section provides debug steps for common issues. The debug feature is a valuable resource to use in hardware debug. The signal names mentioned in the following individual sections can be probed using the Vivado debug feature for debugging the specific problems.

Ensure that all the timing constraints for the core were properly incorporated from the example design and that all constraints were met during implementation.

- Does it work in post-place and route timing simulation? If problems are seen in hardware but not in timing simulation, this might indicate a PCB issue. Ensure that all clock sources are active and clean.
- Ensure that the `rst_seq_done` is asserted by the wizard.
- Does the `rst_seq_done` signal toggle without the assertion of reset? If yes, this indicates a loss of PLL lock or deassertion of the `DLY_RDY` and `VTC_RDY` signals.
- Ensure that the PLL Lock signal is asserted.
- Ensure that the `VTC_RDY` and `DLY_RDY` signals are asserted for all `BITSLICE` and `BITSLICE_CONTROL` signals.
- Ensure that the synthesis and implementation of the design is successful without any DRC errors.
- Check that RIU Clock is always present in the system during the deassertion of reset.
- Check the status of `FIFO_EMPTY` signals.
- If Bitslip logic is enabled, ensure that `start_bitslip` is driven Low whenever the top-level `rst` pin is asserted.
- If Bitslip logic is enabled, ensure that `start_bitslip` is asserted after the Tx side is transmitting.
- Ensure PLL reset requirements are met.

Additional Resources and Legal Notices

Xilinx Resources

For support resources such as Answers, Documentation, Downloads, and Forums, see [Xilinx Support](#).

References

These documents provide supplemental material useful with this product guide:

1. *UltraScale Architecture SelectIO Resources: Advance Specification User Guide* ([UG571](#))
2. *Kintex UltraScale Architecture Data Sheet* ([DS892](#))
3. *Virtex UltraScale FPGAs Data Sheet* ([DS893](#))
4. *Kintex UltraScale+ FPGAs Data Sheet* ([DS922](#))
5. *Vivado Design Suite User Guide: Designing IP Subsystems using IP Integrator* ([UG994](#))
6. *Vivado Design Suite User Guide: Designing with IP* ([UG896](#))
7. *Vivado Design Suite User Guide: Getting Started* ([UG910](#))
8. *Vivado Design Suite User Guide: Logic Simulation* ([UG900](#))
9. *Bitslip in Logic Application Note* ([XAPP1208](#))
10. *Vivado Design Suite User Guide: Programming and Debugging* ([UG908](#))
11. *Vivado Design Suite User Guide - Implementation* ([UG904](#))

Revision History

The following table shows the revision history for this document.

Date	Version	Revision
04/06/2015	3.0	<ul style="list-style-type: none"> • Added UltraScale+ support. • Changed to 1600 Mb/s in the Application and Performance sections. • Updated clk_p, clk_n, clk, rst, and bg<x>_pin<y>_<pin num> descriptions in Table 2-1. • Updated data_from_fabric_<sig_name>_<y> [sf -1:0], data_to_fabric_<sig_name>_<y> [sf -1:0] descriptions in Table 2-2. • Removed pll0_clkfbout and bitslip_<i> from Table 2-2. • Renamed riu_clk_bg<m> to riu_clk. • Added the following signals to Table 2-2: fifo_rd_data_valid, start_bitslip, rtx_bitslip_sync_done, rx_bitslip_sync_done, shared_pll0_clkout0_in, shared_pll1_clkout0_in, shared_pll0_clkoutphy_in, shared_pll1_clkoutphy_in, shared_pll0_locked_in, shared_pll0_locked_in, shared_pll0_clkoutphy_out, and shared_pll1_clkoutphy_out
		<ul style="list-style-type: none"> • Added PLL Instantiation, RIU Clock, and Advanced Strobe/Clock Mode sections to the Clocking section in Chapter 3. • Added RIU from PLL diagram to Resets section in Chapter 3. • Updated the note in the Clocking of RX_BITSLICE section • Added text to Edge DDR section. • Replaced all instances to BiDir with BiDir (Beta) • Added Beta suffix to all occurrences of Async/None/Fractional.
		<ul style="list-style-type: none"> • Replaced all occurrences of Strobe with Strobe/Clock. • Updated the Interface Speed option. Removed Table 4-1. • Added a new selection - Select if PLL is included in Core or Example design in Chapter 4.
		<ul style="list-style-type: none"> • Replaced "PLL0" with "PLL" for the option Enable PLL0 CLKOUT1 • Removed Enable PLL0 CLKFBOUT1 option. • Add new options for the Configuration tab Chapter 4: Enable Advanced Strobe Selection, Generate RIU Clock from PLL, FIFO Read Enable User Control, Append Pin No. to IOs, Bitslip training Pattern, Differential Termination, Differential Tx Pre-Emphasis, Differential Rx Equalization, Single Ended Termination, Single Ended Tx Pre-Emphasis, Single Ended Rx Equalization
		<ul style="list-style-type: none"> • Added new options: StrobeP, StrobeN, InvStrobeP, InvStrobeN, Init Val as Pin Selection tab options.
		<ul style="list-style-type: none"> • Removed Bitslip Mode from Table 4-2. • Added four timing diagrams to the FIFO Read Enable User Control section in Chapter 4. • Updated Figures 4-1 through 4-3 for Vivado options. • Removed I/O Standard and Placement section.

Date	Version	Revision
04/06/2015 (Continued)	3.0	<ul style="list-style-type: none"> Added DUT Configuration Tables 5-2 and 5-3. Updated the description of the RIU Interface Bitslip Training Pattern options. Added a timing diagram to the Bitslip Training Pattern option.
09/30/2015	2.0	<p>IP Facts table</p> <ul style="list-style-type: none"> Added a link to the Performance and Resource Utilization web page. <p>Chapter 1, Overview</p> <ul style="list-style-type: none"> Updated Features section on the IP Facts page. Updated Feature Summary, Applications, and Unsupported Features sections. <p>Chapter 2, Product Specification</p> <ul style="list-style-type: none"> Updated Figure 2-1. Updated Performance section. Added a link to the Performance and Resource Utilization web page. Removed all of the device-specific information in the Resource Utilization section. Completely revised the Port Descriptions section. Replaced Table 2-2 and 2-3 with new tables. <p>Chapter 3, Designing with the Core</p> <ul style="list-style-type: none"> Completely revised General Design Guidelines and Clocking sections. Added Resets section. Updated Figure 3-1. <p>Chapter 4, Design Flow Steps</p> <ul style="list-style-type: none"> Completely revised Customizing and Generating the Core section. Updated all illustrations and their descriptions. Replaced Table 4-1 with new table. Added a new figure to the Output Generation section. Updated most of the subsections in the Constraining the Core section. <p>Chapter 5, Test Bench</p> <ul style="list-style-type: none"> Replaced Figure 6-1 with a new waveform.
04/01/2015	1.1	<ul style="list-style-type: none"> Added support for bidirectional buses. Added User Parameters section.
10/01/2014	1.1	<ul style="list-style-type: none"> Added support for Bitslip modes. Removed the if<k>_ext_clk_to_fabric port.
04/02/2014	1.0	Initial Xilinx release.

Please Read: Important Legal Notices

The information disclosed to you hereunder (the "Materials") is provided solely for the selection and use of Xilinx products. To the maximum extent permitted by applicable law: (1) Materials are made available "AS IS" and with all faults, Xilinx hereby DISCLAIMS ALL WARRANTIES AND CONDITIONS, EXPRESS, IMPLIED, OR STATUTORY, INCLUDING BUT NOT LIMITED TO WARRANTIES OF MERCHANTABILITY, NON-INFRINGEMENT, OR FITNESS FOR ANY PARTICULAR PURPOSE; and (2) Xilinx shall not be liable (whether in contract or tort, including negligence, or under any other theory of liability) for any loss or damage of any kind or nature related to, arising under, or in connection with, the Materials (including your use of the Materials), including for any direct, indirect, special, incidental, or consequential loss or damage (including loss of data, profits, goodwill, or any type of loss or damage suffered as a result of any action brought by a third party) even if such damage or loss was reasonably foreseeable or Xilinx had been advised of the possibility of the same. Xilinx assumes no obligation to correct any errors contained in the Materials or to notify you of updates to the Materials or to product specifications. You may not reproduce, modify, distribute, or publicly display the Materials without prior written consent. Certain products are subject to the terms and conditions of Xilinx's limited warranty, please refer to Xilinx's Terms of Sale which can be viewed at <http://www.xilinx.com/legal.htm#tos>; IP cores may be subject to warranty and support terms contained in a license issued to you by Xilinx. Xilinx products are not designed or intended to be fail-safe or for use in any application requiring fail-safe performance; you assume sole risk and liability for use of Xilinx products in such critical applications, please refer to Xilinx's Terms of Sale which can be viewed at <http://www.xilinx.com/legal.htm#tos>.

© Copyright 2014-2016 Xilinx, Inc. Xilinx, the Xilinx logo, Artix, ISE, Kintex, Spartan, Virtex, Vivado, Zynq, and other designated brands included herein are trademarks of Xilinx in the United States and other countries. All other trademarks are the property of their respective owners.